

# $\Sigma$ -L Series SGML/SGDL (for speed/torque control) USER'S MANUAL

AC Servomotor and Driver

SGML Servomotor

SGDL-□□□S Servopack

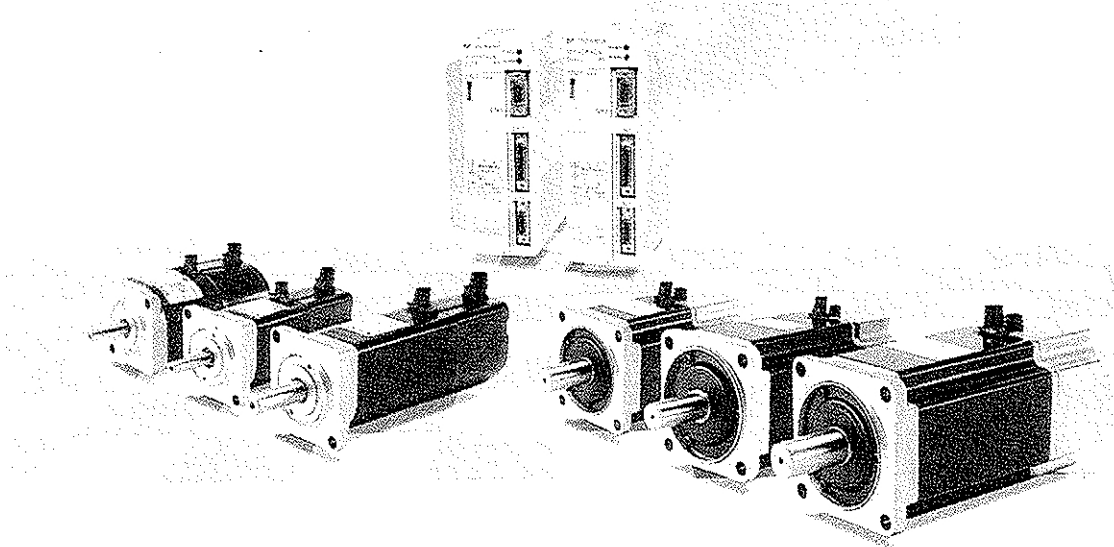

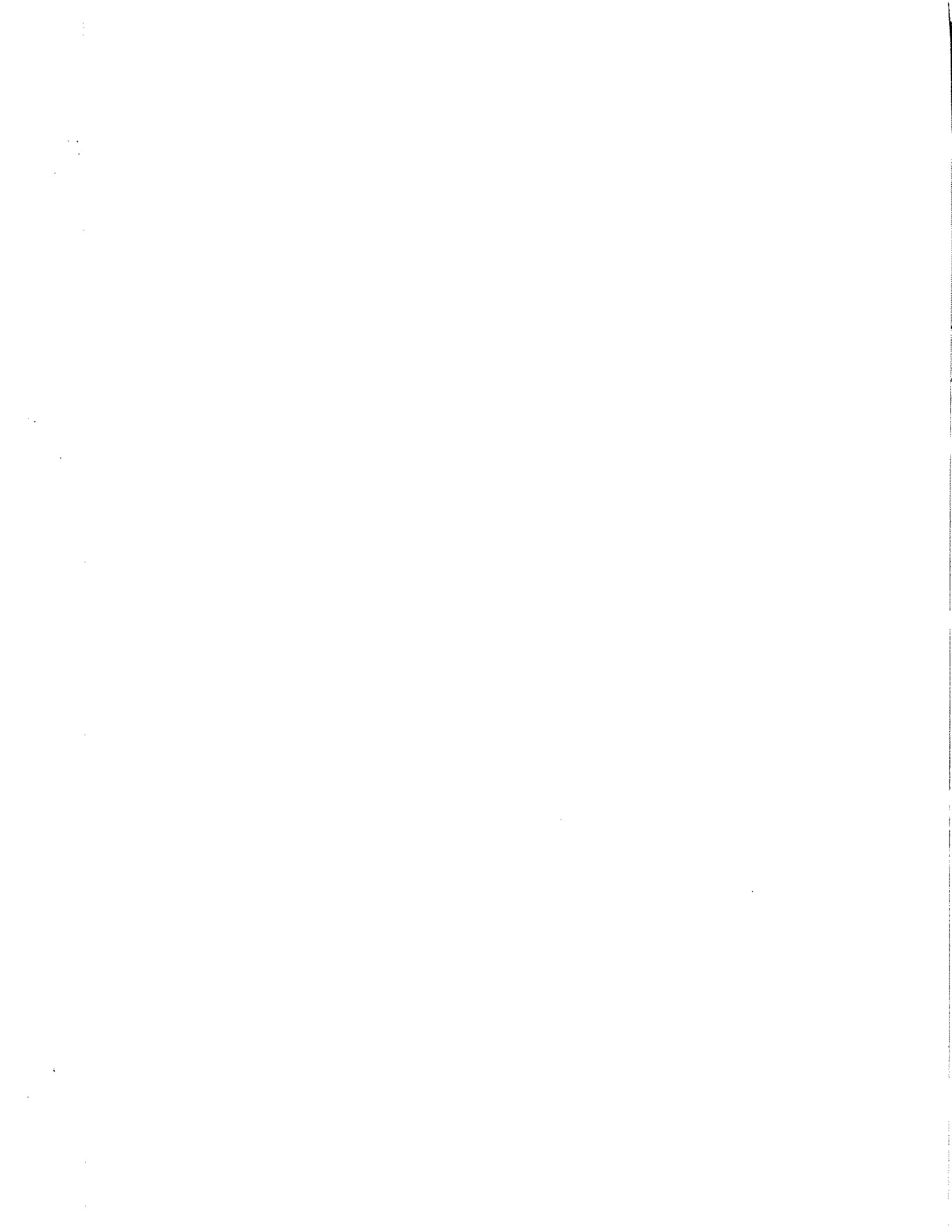

This manual covers the products of the  $\Sigma$ -L Series SGML/SGDL, which feature superior functions and performance. This manual was designed to provide comprehensible information for users who are about to use a servo for the first time as well as for users who already have experience in using servos. This manual enables users to understand how to design, install, operate, and maintain a servo system. Keep this manual in a convenient location and refer to it whenever necessary in operating and maintaining the servo system.

#### General Precautions

- Some drawings in this manual are shown with the protective cover or shields removed, in order to describe the detail with more clarity. Make sure all covers and shields are replaced before operating this product.
- Some drawings in this manual are shown as typical example and may differ from the shipped product.
- This manual may be modified when necessary because of improvement of the product, modification or changes in specifications.  
Such modification is made as a revision by renewing the manual No.
- To order a copy of this manual, if your copy has been damaged or lost, contact your YASKAWA representative listed on the last page stating the manual No. on the front cover.
- YASKAWA is not responsible for accidents or damages due to any modification of the product made by the user since that will void our guarantee.

# NOTES FOR SAFE OPERATION

Read this manual thoroughly before installation, operation, maintenance or inspection of the AC Servo Drives. In this manual, the NOTES FOR SAFE OPERATION are classified as “WARNING” or “CAUTION”.



Indicates a potentially hazardous situation which, if not avoided, could result in death or serious personal injury.

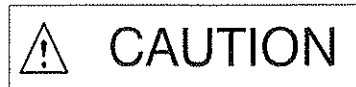

Indicates a potentially hazardous situation which, if not avoided, may result in minor or moderate personal injury and/or damage to the equipment.

In some instances, items described in  may also result in a serious accident. In either case, follow these important items.

## WARNING

### (WIRING)

- Grounding must be in accordance with the national code and consistent with sound local practices.  
Failure to observe this warning may lead to electric shock or fire.

### (OPERATION)

- Never touch any rotating motor parts or machine movable part during operation.  
Failure to observe this warning may result in personal injury.

### (INSPECTION AND MAINTENANCE)

- Be sure to turn OFF power before inspection or maintenance.  
Otherwise, electric shock may result.
- Never open the terminal cover while power is ON, and never turn ON power when the terminal cover is open.  
Otherwise, electric shock may result.
- After turning OFF power, wait at least five minutes before servicing the product.  
Otherwise, residual electric charges may result in electric shock.

## CAUTION



### (RECEIVING)

- Use the specified combination of SERVOMOTOR and SERVOPACK.  
Failure to observe this caution may lead to fire or failure.

### (INSTALLATION)

- Never use the equipment where it may be exposed to splashes of water, corrosive or flammable gases, or near flammable materials.  
Failure to observe this caution may lead to electric shock or fire.

### (WIRING)

- Do not connect three-phase power supply to output terminals   and .  
Failure to observe this caution may lead to personal injury or fire.
- Securely tighten screws on the power supply and motor output terminals.  
Failure to observe this caution can result in a fire.
- Never change wiring while power is ON.  
Failure to observe this caution may result in electric shock or personal injury.

 CAUTION

(OPERATION)

- To avoid inadvertent accidents, run the SERVOMOTOR only in test run (without load).  
Failure to observe this caution may result in personal injury.
- Before starting operation with a load connected, set up user constants suitable for the machine.  
Starting operation without setting up user constants may lead to overrun failure.
- Before starting operation with a load connected, make sure emergency-stop procedures are in place.  
Failure to observe this caution may result in personal injury.
- During operation, do not touch the heat sink.  
Failure to observe this caution may result in burns.

(INSPECTION AND MAINTENANCE)

- Do not disassemble the SERVOMOTOR.  
Failure to observe this caution may result in electric shock or personal injury.
- Never change wiring while power is ON.  
Failure to observe this caution may result in electric shock or personal injury.

# Manual Contents

This manual provides  $\Sigma$ -L Series users with information on the following:

- Checking the product on delivery and basic applications of the servo.
- Servo applications.
- Selecting an appropriate servo for your needs and placing an order.
- Inspection and maintenance.

## Manual Structure

All chapters in this manual are classified into one or more of three areas according to their contents: A, B, and C. Refer to the applicable chapters for the information you require.

**A:** Chapters explaining how to select a servo: For users who wish to gain a basic understanding of  $\Sigma$ -L Series products or who need to select an appropriate servo.

**B:** Chapters explaining how to design a servo system: For users who are about to design, install, and operate a  $\Sigma$ -L Series Servo Control System.

**C:** Chapters explaining maintenance: For users who are going to maintain and troubleshoot  $\Sigma$ -L Series products.

<b>Chapter</b>	<b>Title</b>	<b>Page</b>	<b>Area</b>
<b>CHAPTER 1</b>	<b>Basic Uses of <math>\Sigma</math>-L series Products</b> .....	1 .....	<b>B</b>
	Describes steps to take when product is received, plus basic wiring and application methods.		
<b>CHAPTER 2</b>	<b>Applications of <math>\Sigma</math>-L series Products</b> .....	31 .....	<b>B</b>
	Describes the effective usage of $\Sigma$ -L Series features according to application.		
<b>CHAPTER 3</b>	<b>Using the Digital Operator</b> .....	97 .....	<b>B</b>
	Describes operating procedures for $\Sigma$ -L Series servos, turning features ON and OFF, setting control constants, etc.		
<b>CHAPTER 4</b>	<b>Servo Selection and Data Sheets</b> .....	129 .....	<b>A, B</b>
	Describes selection methods for $\Sigma$ -L Series servos and peripherals and provides servo specifications.		
<b>CHAPTER 5</b>	<b>Inspection, Maintenance, and Troubleshooting</b> .....	217 .....	<b>C</b>
	Describes user maintenance and troubleshooting.		
<b>APPENDIXES</b>			
<b>A</b>	Servo Adjustment .....	237 .....	<b>B, C</b>
<b>B</b>	List of I/O Signals .....	247 .....	<b>A, B, C</b>
<b>C</b>	List of User Constants .....	253 .....	<b>B, C</b>
<b>INDEX</b>	.....	256 .....	<b>A, B, C</b>

## Basic Terms

Unless otherwise specified, the following definitions are used:

Servomotor:  $\Sigma$ -L Series SGML Servomotor

Servopack: An amplifier (Trademark of Yaskawa servo amplifier "SGDL Servopack")

Servodrive: A SGML Servomotor and an amplifier (SGDL Servopack)

Servo system: A complete servo control system consisting of servodrive, host controller, and peripheral devices

## Visual Aids

The following aids are used to indicate certain types of information for easier reference.



Indicates references for additional information.



Technical terms placed in bold in the text are briefly explained in a "TERMS" section at the bottom of the page. The following kinds of technical terms are explained: Technical terms that need to be explained to users who are not very familiar with servo systems or electronic devices and technical terms specific to  $\Sigma$ -L Series Servos that need to be explained in descriptions of functions.



The text indicated by this icon explains the operating procedure using hand-held type digital operator (Type: JUSP-OP02A-1).

JUSP-OP02A-1

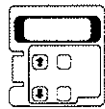

JUSP-OP03A

The text indicated by this icon explains the operating procedure using mount type digital operator (Type: JUSP-OP03A).

**NOTE** A  $\Sigma$ -L Series Servodrive alone cannot ensure the functionality and performance of the entire machine control system. It must be combined with an appropriate machine and host controller so that the entire control system works properly. Therefore, carefully read the instruction manuals for the machine to be used before attempting to operate the servodrive.

©Yaskawa, 1998

All rights reserved. No part of this publication may be reproduced, stored in a retrieval system, or transmitted, in any form, or by any means, mechanical, electronic, photocopying, recording, or otherwise, without the prior written permission of Yaskawa. No patent liability is assumed with respect to the use of the information contained herein. Moreover, because Yaskawa is constantly striving to improve its high-quality products, the information contained in this manual is subject to change without notice. Every precaution has been taken in the preparation of this manual. Nevertheless, Yaskawa assumes no responsibility for errors or omissions. Neither is any liability assumed for damages resulting from the use of the information contained in this publication.





# CONTENTS

<b>CHAPTER 1</b>	<b>BASIC USES OF <math>\Sigma</math>-L SERIES PRODUCTS</b>	<b>1</b>
1.1	Precautions	2
1.1.1	Notes on Use	2
1.2	Installation	4
1.2.1	Checking on Delivery	4
1.2.2	Installing the Servomotor	5
1.2.3	Installing the Servopack	8
1.2.4	Power Loss	10
1.3	Connection and Wiring	11
1.3.1	Connecting to Peripheral Devices	11
1.3.2	Main Circuit Wiring and Power ON Sequence	14
1.3.3	Examples of Connecting I/O Signal Terminals	16
1.4	Conducting a Test Run	20
1.4.1	Test Run in Two Steps	20
1.4.2	Step 1: Conducting a Test Run for Motor without Load	22
1.4.3	Step 2: Conducting a Test Run with the Motor Connected to the Machine	26
1.4.4	Supplementary Information on Test Run	28
1.4.5	Minimum User Constants Required and Input Signals	29
<b>CHAPTER 2</b>	<b>APPLICATIONS OF <math>\Sigma</math>-L SERIES PRODUCTS</b>	<b>31</b>
2.1	Setting User Constants According to Machine Characteristics	34
2.1.1	Changing the Direction of Motor Rotation	34
2.1.2	Setting the Overtravel Limit Function	35
2.1.3	Restricting Torque	36
2.2	Setting User Constants According to Host Controller	43
2.2.1	Inputting Speed Reference	43
2.2.2	Using Encoder Output	47
2.2.3	Using Contact I/O Signals	49
2.2.4	Using Contact Input Speed Control	51
2.2.5	Using Torque Control	55
2.2.6	Using Torque Restriction by Analog Voltage Reference	61
2.3	Setting Up the $\Sigma$ -L Servopack	62
2.3.1	Using Autotuning Function	62
2.3.2	Setting Servo Gain	62
2.3.3	Setting the Torque Reference Filter Time Constant	63
2.3.4	Using the Soft Start Function	64
2.3.5	Using Proportional Control	64
2.3.6	Setting the Mode Switch Level	65
2.4	Setting Stop Mode	67
2.4.1	Adjusting Offset	67
2.4.2	Dynamic Brake	68
2.4.3	Using Zero-Clamp	68
2.4.4	Using Holding Brake	70
2.5	Forming a Protective Sequence	72
2.5.1	Using Servo Alarm Output and Alarm Code Output	72
2.5.2	Using Servo ON Input Signal	75
2.5.3	Using Running Output Signal	76
2.5.4	Handling of Power Failure	78

# CONTENTS

2.6	Special Wiring .....	80
2.6.1	Wiring Instructions .....	80
2.6.2	Wiring for Noise Control .....	82
2.6.3	Using More Than One Servo Drive .....	87
2.6.4	Using Regenerative Units .....	88
2.6.5	Using SGDL Servopack with High Voltage Line .....	91
2.6.6	Connector Terminal Layouts .....	93
<b>CHAPTER 3 USING THE DIGITAL OPERATOR .....</b>		<b>97</b>
3.1	Basic Operations .....	98
3.1.1	Connecting the Digital Operator .....	98
3.1.2	Resetting Servo Alarms .....	99
3.1.3	Basic Functions and Mode Selection .....	100
3.1.4	Operation in Status Display Mode .....	101
3.1.5	Operation in User Constant Setting Mode .....	102
3.1.6	Operation in Monitor Mode .....	107
3.2	Using the Functions .....	110
3.2.1	Operation in Alarm Trace-back Mode .....	110
3.2.2	Operation Using the Digital Operator .....	112
3.2.3	Autotuning .....	115
3.2.4	Clearing Alarm Trace-back Data .....	121
3.2.5	Checking Motor Type .....	122
3.2.6	Checking Software Version .....	123
3.2.7	Speed Reference Offset Automatic Adjustment .....	123
3.2.8	Speed Reference Offset Manual Adjustment Mode .....	126
<b>CHAPTER 4 SERVO SELECTION AND DATA SHEETS .....</b>		<b>129</b>
4.1	Selecting a $\Sigma$ -L Series Servo .....	131
4.1.1	Selecting a Servomotor .....	131
4.1.2	Selecting a Servopack .....	142
4.1.3	Selecting a Digital Operator .....	144
4.2	SGML Servomotor .....	145
4.2.1	Ratings and Specifications .....	145
4.2.2	Mechanical Characteristics .....	154
4.3	Servopack Ratings and Specifications .....	156
4.3.1	Ratings and Specifications .....	156
4.3.2	Overload Characteristics .....	159
4.3.3	Starting Time and Stopping Time .....	160
4.3.4	Load Inertia .....	160
4.3.5	Overhanging Loads .....	162
4.3.6	Power Consumption .....	163
4.4	$\Sigma$ -L Series Dimensional Drawings .....	164
4.4.1	Servomotor Dimensional Drawings .....	164
4.4.2	Servopack Dimensional Drawings .....	178
4.4.3	Digital Operator Dimensional Drawings .....	181
4.5	Selecting Peripheral Devices .....	182
4.5.1	Selecting Peripheral Devices .....	182

# CONTENTS

4.6	Specifications and Dimensional Drawings of Peripheral Devices .....	187
4.6.1	Cable Specifications and Peripheral Devices .....	187
4.6.2	Motor Cables .....	190
4.6.3	Connector Kits .....	193
4.6.4	Brake Power Supply .....	197
4.6.5	Encoder Cables .....	199
4.6.6	CN1 Connector .....	203
4.6.7	Connector Terminal Block Converter Unit .....	205
4.6.8	Cable With CN1 Connector and One End Without Connector .....	207
4.6.9	Circuit Breaker .....	207
4.6.10	Noise Filter .....	208
4.6.11	Magnetic Contactor .....	209
4.6.12	Surge Suppressor .....	210
4.6.13	Regenerative Unit .....	211
4.6.14	Cables for Connecting PC and Servopack .....	213
 <b>CHAPTER 5 INSPECTION, MAINTENANCE, AND TROUBLESHOOTING</b>		<b>217</b>
5.1	Inspection and Maintenance .....	218
5.1.1	Servomotor .....	218
5.1.2	Servopack .....	219
5.2	Troubleshooting .....	220
5.2.1	Troubleshooting Problems with Alarm Display .....	220
5.2.2	Troubleshooting Problems With No Alarm Display .....	233
5.2.3	Internal Connection Diagram and Instrument Connection Examples .....	234
 <b>APPENDIXES</b>		
A.1	$\Sigma$ -L Series AC Servopack Gain Adjustment .....	238
A.1.1	$\Sigma$ -L Series AC Servopacks and Gain Adjustment Methods .....	238
A.1.2	Basic Rules for Gain Adjustment .....	239
A.2	Adjusting a Speed-control Servopack .....	240
A.2.1	Adjusting Using Auto-tuning .....	240
A.2.2	Manual Adjustment .....	241
A.3	Gain Setting References .....	244
A.3.1	Guidelines for Gain Settings According to Load Inertia Ratio .....	244
B	List of I/O Signals .....	247
C	List of User Constants .....	253

## INDEX

# BASIC USES OF $\Sigma$ -L SERIES PRODUCTS

# 1

This chapter describes the first things to do when  $\Sigma$ -L Series products are delivered. It also explains the most fundamental ways of connecting and operating  $\Sigma$ -L Series products. Both first-time and experienced servo users **must read** this chapter.

<b>1.1</b>	<b>Precautions</b> .....	<b>2</b>
1.1.1	Notes on Use .....	2
<b>1.2</b>	<b>Installation</b> .....	<b>4</b>
1.2.1	Checking on Delivery .....	4
1.2.2	Installing the Servomotor .....	5
1.2.3	Installing the Servopack .....	8
1.2.4	Power Loss .....	10
<b>1.3</b>	<b>Connection and Wiring</b> .....	<b>11</b>
1.3.1	Connecting to Peripheral Devices .....	11
1.3.2	Main Circuit Wiring and Power ON Sequence .....	14
1.3.3	Examples of Connecting I/O Signal Terminals .....	16
<b>1.4</b>	<b>Conducting a Test Run</b> .....	<b>20</b>
1.4.1	Test Run in Two Steps .....	20
1.4.2	Step 1: Conducting a Test Run for Motor without Load .....	22
1.4.3	Step 2: Conducting a Test Run with the Motor Connected to the Machine .....	26
1.4.4	Supplementary Information on Test Run .....	28
1.4.5	Minimum User Constants Required and Input Signals .....	29

## 1.1 Precautions

▣ This section provides notes on using  $\Sigma$ -L Series products.

1.1.1 Notes on Use ..... 2

### 1.1.1 Notes on Use

**NOTE** Always note the following to ensure safe use.

**Two types of supply voltage are available, 100 V and 200 V.**

Both  $\Sigma$ -L Series Servomotor and Servopack have 100 V and 200 V types. Be sure to use the correct type.

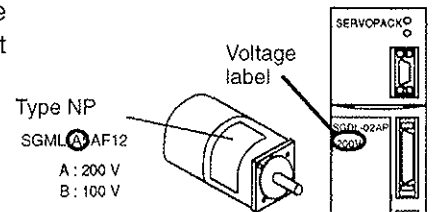

**Always use the SGML Servomotor and SGDL Servopack in pairs.**

The SGML Servomotor cannot run without the SGDL Servopack. Do not plug the SGML Servomotor directly into the commercial power supply. (Direct connection to the commercial power supply will damage the Servomotor.)

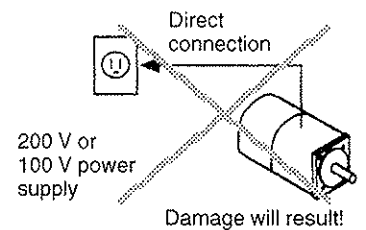

**Do not change wiring when power is ON.**

Always turn the power OFF before connecting or disconnecting a connector. (Except for Digital Operator (Types: JUSP-OP02A-1, JUSP-OP03A))

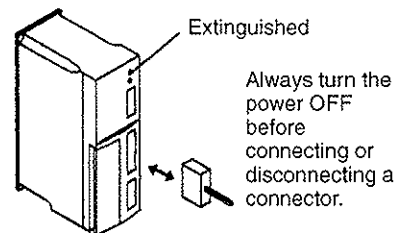

**Note that residual voltage still remains in the Servopack even after the power is turned OFF.**

Even after the power is turned OFF, residual voltage still remains in the capacitor inside the Servopack. If inspection is to be performed after the power is turned OFF, always wait at least 5 minutes to avoid the risk of an electrical shock.

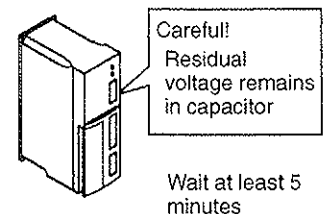

**Always follow the specified installation method.**

The Servopack generates heat. Install the Servopack so that it can radiate heat freely. Note also that the Servopack must be in an environment free from condensation, vibration and shock.

Provide sufficient clearance

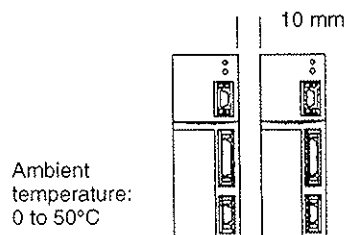

**Perform noise reduction and grounding properly.**

If the signal line is noisy, vibration or malfunction will result.

- Separate high-voltage cables from low-voltage cables.
- Use cables as short as possible.
- Use at least class 3 grounding (ground resistance 100Ω or below) for the Servomotor and Servopack.
- Never use a line filter for the power supply in the motor circuit.

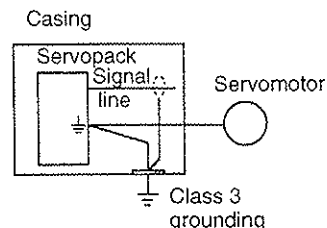

**Conduct a voltage resistance test under the following conditions.**

- Voltage: 1,500 Vrms AC, one minute
- Braking current: 18 mA
- Frequency: 50/60 Hz
- Voltage applied point: Between R, T terminals and frame ground (connect terminals R and T securely.)

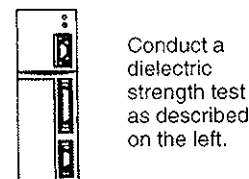

**Use a fast-response type ground-fault interrupter.**

For a ground-fault interrupter, always use a fast-response type or one designed for PWM inverters. Do not use a time-delay type.

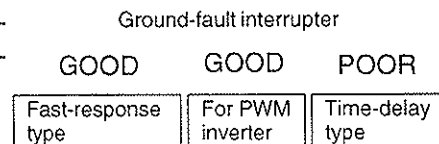

**Do not perform continuous operation under overhanging load.**

Continuous operation cannot be performed by rotating the motor from the load and applying regenerative braking. Regenerative braking by the Servopack can be applied only for a short period, such as the motor deceleration time.

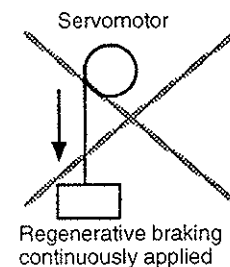

**The Servomotor cannot be operated by turning the power ON and OFF.**

Frequently turning the power ON and OFF causes the internal circuit elements to deteriorate. Always start or stop the servomotor by using reference pulses.

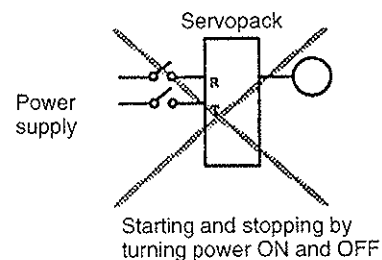

## 1.2 Installation

This section describes how to check  $\Sigma$ -L Series products on delivery and how to install them.

1.2.1	Checking on Delivery .....	4
1.2.2	Installing the Servomotor .....	5
1.2.3	Installing the Servopack .....	8
1.2.4	Power Loss .....	10

### 1.2.1 Checking on Delivery

1) When  $\Sigma$ -L Series products are delivered, check the following items:

Check Items	Remarks
Check if the delivered products are the ones you ordered.	Check the types marked on the nameplates of Servomotor and Servopack (see the table below).
Check if the motor shaft rotates smoothly.	If the motor shaft is smoothly turned by hand, it is normal. However, if the motor has brakes, it cannot be turned manually.
Check for damage.	Check the overall appearance, and check for damage or scratches resulting from transportation.
Check screws for looseness.	Check for looseness by using a screwdriver as necessary.

If any of the above items are faulty or incorrect, contact the dealer from which you purchased the products or your nearest local sales representative.

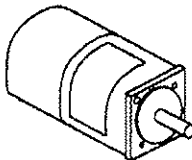
Appearance	Nameplate	Type
 <p>Servo motor</p> <p><math>\Sigma</math>-L Series SGML Servomotor</p>	<p>Rated output</p> <p>Servomotor type</p> <p>Rated current</p> <p>Rated torque</p> <p>AC SERVO MOTOR SGML-02AF12</p> <p>W200 N·m 0.637 A 2.0</p> <p>/min 3000 1995.06</p> <p>S/N 598022-1-3</p> <p>YASKAWA ELECTRIC CORPORATION JAPAN</p> <p>Serial number</p> <p>Manufacturing date</p> <p>Rated rotation speed</p>	<p>SGML - 01 A F 1 2 <input type="checkbox"/></p> <p><math>\Sigma</math>-Series SGML: SGML Servomotor</p> <p>Rated Output A3:0.04HP A5:0.07HP 01:0.13HP 02:0.27HP 03:0.40HP 04:0.53HP 08:1.01HP</p> <p>Power supply A:200V B:100V</p> <p>Encoder specifications F: 1024P/R incremental encoder</p> <p>Design revision order</p> <p>Shaft specifications 2: Straight without key 3: Flat key seat 4: Straight with key</p> <p>Option Blank: Standard (W/O brake) B: With brake (90VDC) C: With brake (24VDC)</p>

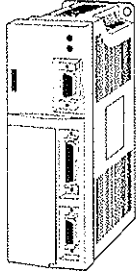
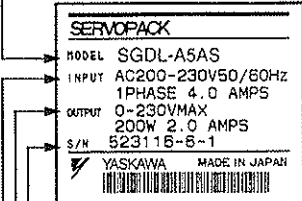

	Appearance	Nameplate	Type
<p>Servo-pack</p>  <p>Σ-L Series SGDL Servopack</p>	<p>Servopack type</p>  <p>Serial number</p> <p>Output power voltage</p> <p>Applicable power supply</p>	<p>SGDL - 01 A S</p> <p>Σ-L Series SGDL Servopack</p> <p>Rated Output</p> <p>A3:0.04HP A5:0.07HP 01:0.13HP 02:0.27HP 03:0.40HP 04:0.53HP 08:1.01HP</p> <p>Power Supply</p> <p>Type</p> <p>S: For speed/torque control</p>	

### 1.2.2 Installing the Servomotor

Servomotor SGML type can be installed either horizontally or vertically. However, if the Servomotor is installed incorrectly or in an inappropriate location, the service life will be shortened or unexpected problems will occur. To prevent this, always observe the installation instructions described below.

**Before installation:**

Anticorrosive paint is coated on the edge of the motor shaft. Clean off the anticorrosive paint thoroughly using a cloth moistened with thinner.

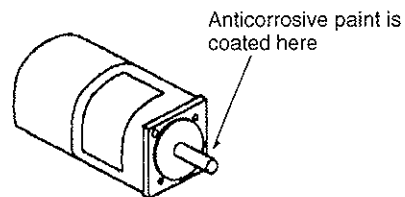

**NOTE** Avoid getting thinner on other parts of the Servomotor when cleaning the shaft.

**Storage:**

When the Servomotor is to be stored with the power cable disconnected, store it in the following temperature range:

Between -20°C and 60°C

**Installation sites:**

The Servomotor SGML type is designed for indoor use.

Install Servomotor in an environment which meets the following conditions:

- Free from corrosive and explosive gases
- Well-ventilated and free from dust and moisture
- Ambient temperature of 0 to 40°C
- Relative humidity of 20% to 80% (non-condensing)
- Inspection and cleaning can be performed easily

If the Servomotor is used in a location subject to water or oil mist, install a shield cover over the Servomotor.

**Alignment:**

Align the shaft of the Servomotor with that of the equipment to be controlled, then connect the shafts with couplings. Install the Servomotor so that alignment accuracy falls within the range shown below.

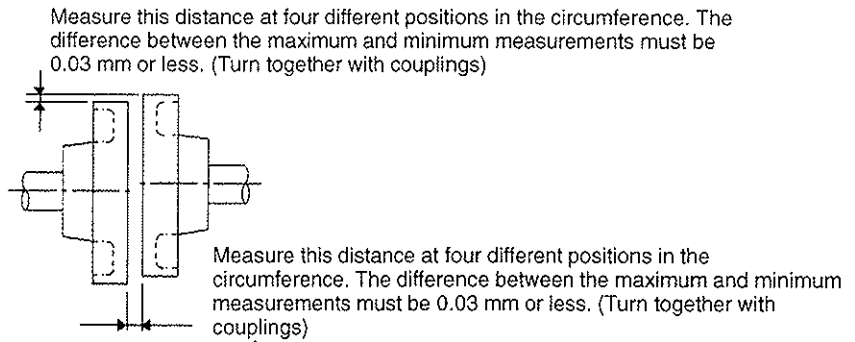

**NOTE** If the shafts are not aligned properly, vibration will occur, resulting in damage to the bearings.

**Mechanical shock to the shaft end must be less than 98m/s<sup>2</sup> (10G) and must be applied no more than twice.**

Design the mechanical system so that **thrust load and radial load** applied to the servomotor shaft end during operation falls within the range shown in the following table.



**Thrust load and radial load**

1. Thrust load: Shaft-end load applied parallel to the centerline of a shaft
2. Radial load: Shaft-end load applied perpendicular to the centerline of a shaft

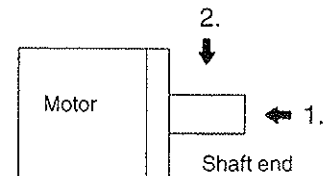

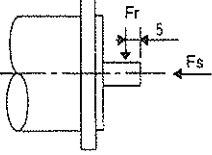
Motor Type	Allowable Radial Load Fr [N(lb)]	Allowable Thrust Load Fs [N(lb)]	Reference Drawing
SGML-A3	68 (15)	54 (12)	 <p>The reference drawing shows a cross-section of a motor shaft. A vertical arrow labeled <math>F_r</math> indicates a radial load applied to the shaft. A horizontal arrow labeled <math>F_s</math> indicates a thrust load applied to the shaft. A dimension line labeled '5' is shown next to the radial load arrow, indicating a distance or offset.</p>
SGML-A5	68 (15)	54 (12)	
SGML-01	78 (17)	54 (12)	
SGML-02	245 (55)	74 (16)	
SGML-03	245 (55)	74 (16)	
SGML-04	245 (55)	74 (16)	
SGML-08	392 (88)	147 (33)	

**Note** The radial load and thrust load values shown above are the maximum allowed values for the sum of the load generated by motor torque and the load externally applied to the shaft.

### 1.2.3 Installing the Servopack

Σ-L Series SGDL Servopack is a book-shaped compact servo controller.

Incorrect installation will cause problems. Always observe the installation instructions described in the next page.

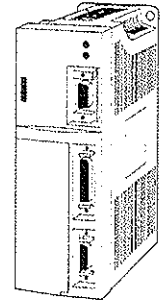

SGDL Servopack

**Storage:**

When the Servopack is to be stored with the power cable disconnected, store it in the following temperature range:

Between  $-20^{\circ}\text{C}$  and  $85^{\circ}\text{C}$

**Installation sites:**

Situation	Notes on Installation
When installed in a control panel	Design the control panel size, unit layout, and cooling method so that the temperature around the periphery of the Servopack does not exceed $50^{\circ}\text{C}$ .
When installed near a heating unit	Suppress radiation heat from the heating unit and a temperature rise caused by convection so that the temperature around the periphery of the Servopack does not exceed $50^{\circ}\text{C}$ .
When installed near a source of vibration	Install a vibration isolator underneath the Servopack to prevent it from receiving vibration.
When installed in a place receiving corrosive gases	Corrosive gases do not immediately affect the Servopack but will eventually cause contactor-related devices to malfunction. Take appropriate action to prevent corrosive gases.
Others	Avoid installation in a hot and humid place or where excessive dust or iron powder is present in the air.

**Orientation:**

Install the Servopack perpendicular to the wall as shown in the figure.

The Servopack must be orientated as shown in the figure because it is designed to be cooled by natural convection.

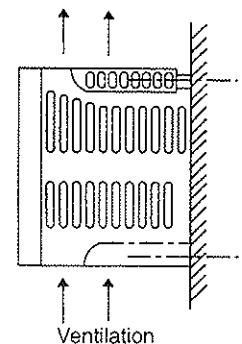

- Firmly secure the Servopack through three mounting holes.

**Installation method:**

When installing multiple Servopacks side by side in a control panel, observe the following installation method:

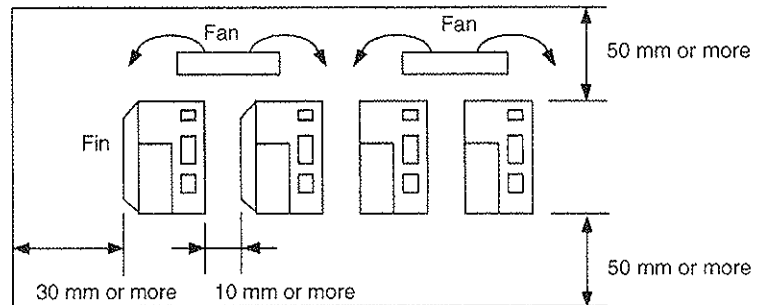

- a) Install Servopack perpendicular to the wall so that the front panel (containing connectors) faces outward.
- b) Provide sufficient space around each Servopack to allow cooling by natural convection.
- c) When installing Servopacks side by side, provide at least 10 mm space between them and at least 50 mm space above and below them as shown in the figure above. Install cooling fans above the Servopacks to prevent the temperature around each Servopack from increasing excessively and also to maintain the temperature inside the control panel evenly.
- d) Maintain the following conditions inside the control panel:
  - Ambient temperature for Servopack: 0 to 50°C
  - Humidity: 90%RH or less
  - Vibration: 0.5G (4.9 m/s<sup>2</sup>)
  - Condensation and freezing: None
  - Ambient temperature to ensure long-term reliability: 45°C or less

**1.2.4 Power Loss**

Servopack SGDL-		Output Current (Effective Value) A	Power Loss W
Supply Voltage 200V	A3AS (30W-0.04HP)	0.42	15
	A5AS (50W-0.07HP)	0.6	18
	01AS (100W-0.13HP)	0.87	20
	02AS (200W-0.27HP)	2.0	35
	04AS (400W-0.53HP)	2.6	45
	08AS (750W-1.01HP)	4.4	60
Supply Voltage 100V	A3BS (30W-0.04HP)	0.63	17
	A5BS (50W-0.07HP)	0.9	20
	01BS (100W-0.13HP)	2.2	30
	02BS (200W-0.27HP)	2.7	47
	03BS (300W-0.40HP)	3.7	70

## 1.3 Connection and Wiring

This section describes how to connect  $\Sigma$ -L Series products to peripheral devices and explains a typical example of wiring the main circuit. It also describes an example of connecting to main host controllers.

1.3.1	Connecting to Peripheral Devices .....	11
1.3.2	Main Circuit Wiring and Power ON Sequence .....	14
1.3.3	Examples of Connecting I/O Signal Terminals .....	16

### 1.3.1 Connecting to Peripheral Devices

- 1) This section shows a standard example of connecting  $\Sigma$ -L Series products to peripheral devices and briefly explains how to connect to each peripheral device.
- 2) Before wiring, turn OFF the power switch and post a notice of "No Conduction". Only a qualified electrical technician should perform the wiring.

# BASIC USES OF $\Sigma$ -L SERIES PRODUCTS

## 1.3.1 Connecting to Peripheral Devices cont.

### Standard connection method for $\Sigma$ -L Series AC Servo Drives:

**Molded-case circuit breaker (MCCB)**

Used to protect power supply line. Shuts the circuit off when overcurrent is detected.

**Noise filter**

Used to eliminate external noise from power supply line.

Types: LF-205A (for SGDL-A3AS, A5AS, 01AS, 02AS, A5BS, 01BS)  
 LF-210 (for SGDL-04AS and 02BS)  
 LF-220 (for SGDL-03BS and 08AS)

**Magnetic contactor**

Turns the servo ON or OFF. Use a surge suppressor for the magnetic contactor.

Type: HI-15E5 (30 A)

**Brake power supply**

Used for Servomotor with brake.

90VDC Specifications

Types: LPSE-2H01 (for 200 V input)  
 LPDE-1H01 (for 100 V input)

**Regenerative unit**

Type: JUSP-RG08

**Exterior type regenerative resistor**

Type: JUSP-RG08C

**Digital**

Allows the user to set user constants or operation references and display operation status or alarm status. The following two types are available in addition to personal computers:

Mount type (JUSP-OP03A)  
 This type can be mounted directly on the Servopack.

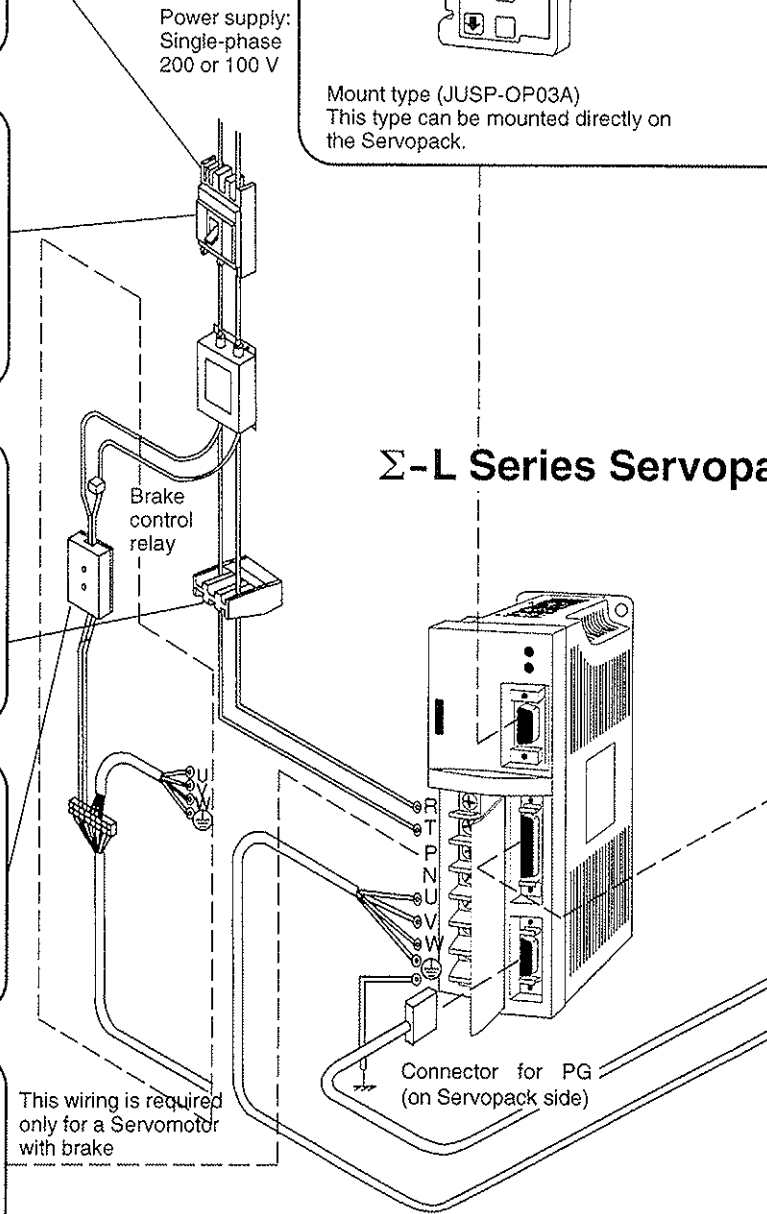

- Connector kits for pulse generator (PG) and for motor are not required if the following parts are ordered:
- Cable with terminal connectors
  - Cable with connector and amplifier terminal



**operator**

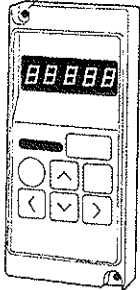

**Personal computer**

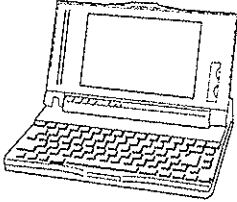

Exclusive-use cables between personal computer and Servopack (for NEC PC or IBM PC) are available (2m, 6.6ft.).  
 Type: DE9405258 (for NEC PC, D-sub 25-pin)  
 DE9408564 (for NEC PC half-pitch connector, 14-pin)  
 DE9408565 (for IBM PC, IBM compatible PC, D-sub 9-pin)

Hand-held type (JUSP-OP02A-1)  
 1-meter(3.3ft.) cable included

**Host controller**

Servopack is compatible with most P.L.C. motion controllers and indexers.

References are input as analog signals.

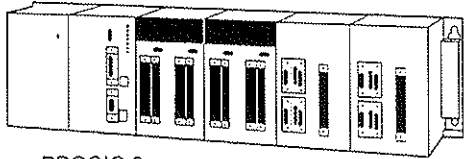

PROGIC-8

**Connector terminal block conversion unit**  
 (Type: JUSP-TA36P)

**CN1 connector kit**  
 (Type: DP9420007)



The terminal block allows connection to a host controller.

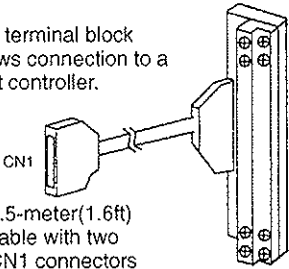

1-meter cable with CN1 connector and one end without connector  
 (Type: DE9404859)

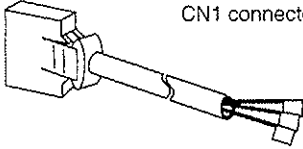

0.5-meter(1.6ft) cable with two CN1 connectors

**Cable for PG**

This cable is used to connect a Servomotor encoder to a Servopack.

Cable for incremental encoder (with connector on both ends)  
 9.8ft: DP9320089-1    16.4ft: DP9320089-2  
 32.8ft: DP9320089-3    49.2ft: DP9320089-4  
 65.6ft: DP9320089-5

A cable with a single connector (without connector on Servopack side) and a cable without connectors are also available.

**Connector kit for PG**

On Servomotor side    On Servopack side

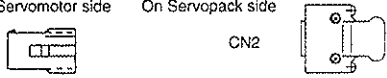

This connector kit is required for cables without connectors. For moving parts, a cable for robot must be ordered separately.

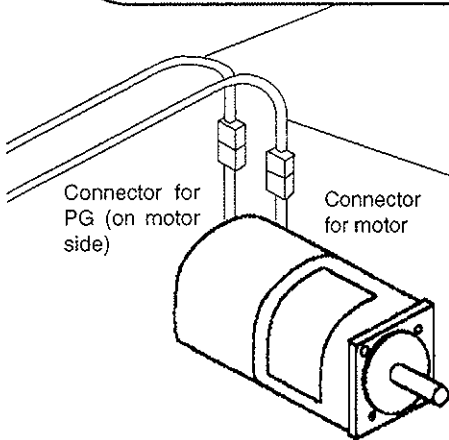

**Σ-L Series Servomotor**

**Cable for motor**

This is a power cable for connecting a Servomotor to a Servopack.

For a Servomotor with brake, this cable is also used to wire the brake.

Without brake (connector and amplifier terminal included)  
 9.8ft: DP9320081-1    16.4ft: DP9320081-2  
 32.8ft: DP9320081-3    49.2ft: DP9320081-4  
 65.6ft: DP9320081-5

With brake (connector and amplifier terminal included)  
 9.8ft: DP9320083-1    16.4ft: DP9320083-2  
 32.8ft: DP9320083-3    49.2ft: DP9320083-4  
 65.6ft: DP9320083-5

A cable without connector and amplifier terminal is also available.

**Connector kit for motor**

Connector for motor (on motor side)



This connector kit is required for cables without connector and amplifier terminal.

### 1.3.2 Main Circuit Wiring and Power ON Sequence

1) The following diagram shows a typical example of wiring the main circuit for Σ-L Series products:

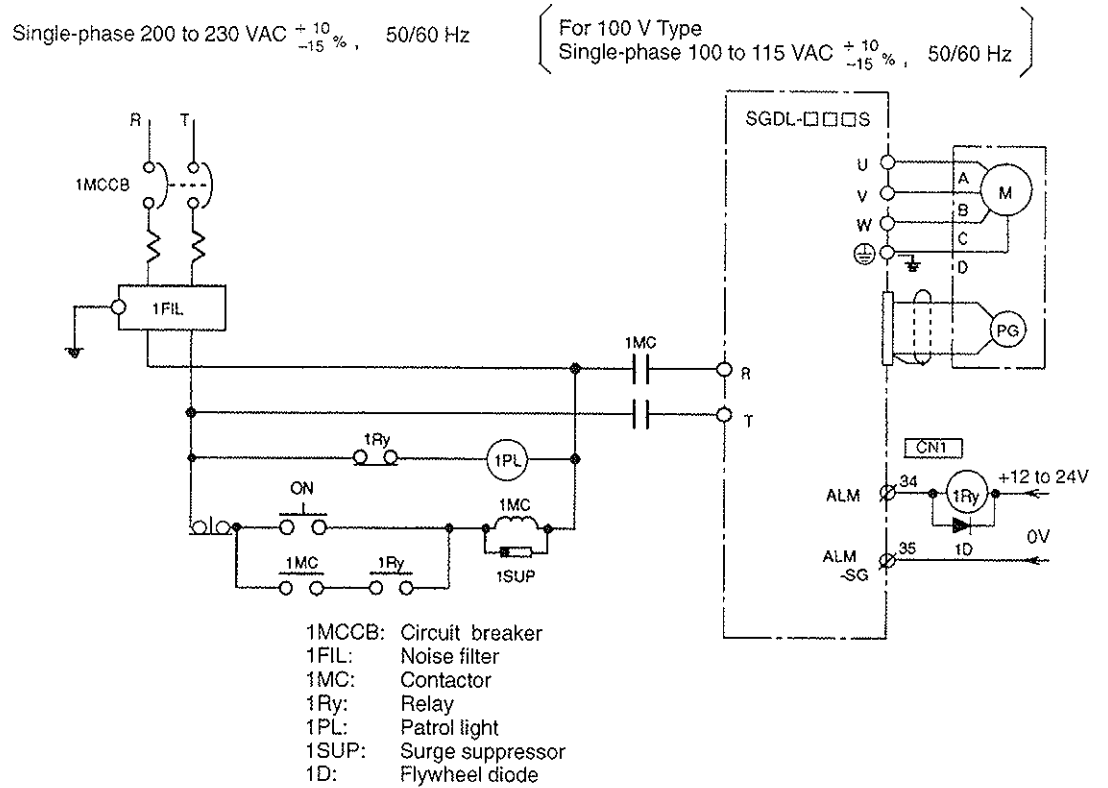

2) The following table shows the name and description of each main circuit terminal:

Terminal Symbol	Name	Description
Ⓡ Ⓣ	Main circuit AC input terminal	Single-phase 200 to 230 VAC $\pm 10\%$ / $-15\%$ , 50/60Hz*
Ⓤ Ⓥ Ⓦ	Motor connection terminal	Connect U to the red motor terminal , V to the white motor terminal, and W to the blue motor terminal
Ⓧ	Ground terminal	Connect to the motor ground terminal (green) for grounding purposes.
Ⓟ Ⓝ	Regenerative unit connection terminal	Connect to a regenerative unit when applicable.

\* For 100 V power supply: Single-phase 100 to 115 VAC  $\pm 10\%$  /  $-15\%$  , 50/60Hz

- 3) Form a power ON sequence as follows:
- Form a power ON sequence so that the power is turned OFF when a servo alarm signal is output. (See the circuit diagram shown on the previous page.)
  - Hold down the power ON push-button for at least two seconds. The Servopack outputs a servo alarm signal for approximately two seconds or less when the power is turned ON. This operation is required to initialize the Servopack.

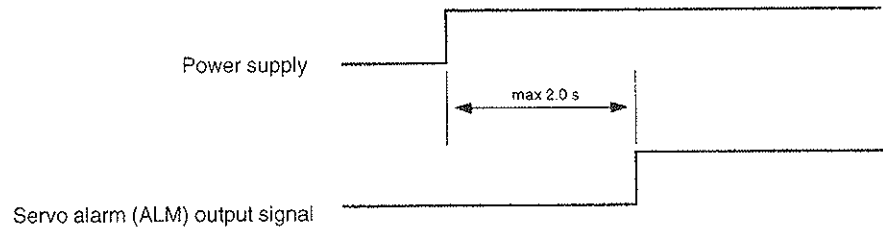

- NOTE**
- After turning the power OFF, do not touch the power terminals for 5 minutes. High voltage may remain in the Servopack.
  - Avoid frequently turning the power ON and OFF. Since the Servopack has a capacitor in the power supply, a high charging current flows (for 0.2 second) when the power is turned ON. Therefore, frequently turning the power ON and OFF causes the main power devices (such as capacitors and fuses) to deteriorate, resulting in unexpected problems.
  - If the Servopack is turned ON immediately after being turned OFF, a power loss alarm may arise. To prevent this, always wait for the time shown in the following table before turning the power ON again:

	Single-phase 200 VAC	Single-phase 100 VAC	Power Holding Time
Servopack Type SGDL-	A3AS, A5AS	A3BS	6 seconds
	01AS, 02AS, 04AS	A5BS, 01BS, 02BS	10 seconds
	08AS	03BS	15 seconds

### 1.3.3 Examples of Connecting I/O Signal Terminals

1) This sub-section provides typical examples of connecting to main host controllers. Connection to other host controllers is also possible. Connect to the host controller according to the connection examples shown below by referring to technical documentation for the host controller.

**NOTE** This sub-section describes signals related to the SGDL Servopack only. For other signals, refer to the relevant technical documentation.

2) Example of Connecting to PROGIC-8

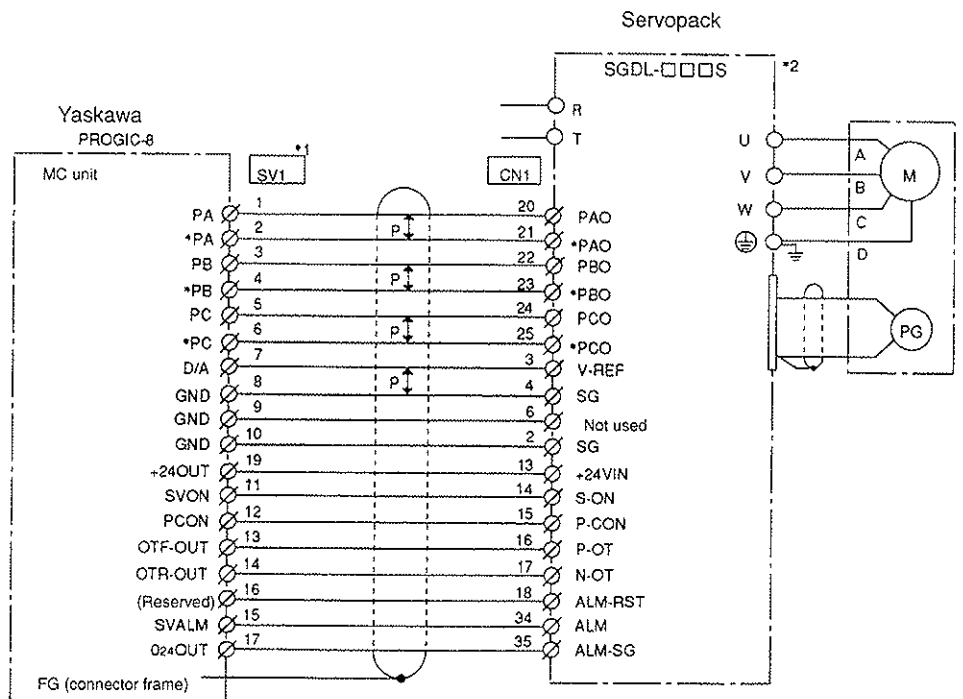

\*1 These pin numbers are also applicable to SV2 to SV4.

\*2 Do not change the standard settings of user constants for the Servopack.

3) Example of Connecting to GL-Series Positioning Module B2833

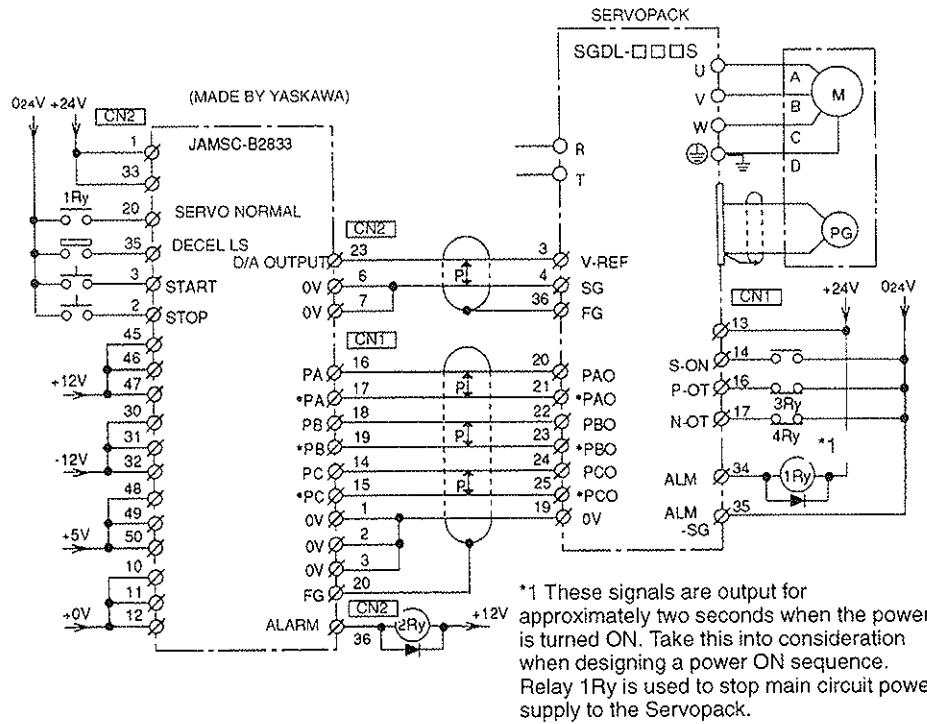

1

## BASIC USES OF $\Sigma$ -L SERIES PRODUCTS

### 1.3.3 Examples of Connecting I/O Signal Terminals cont.

#### 4) Example of Connecting to OMRON Position Control Unit C500-NC221

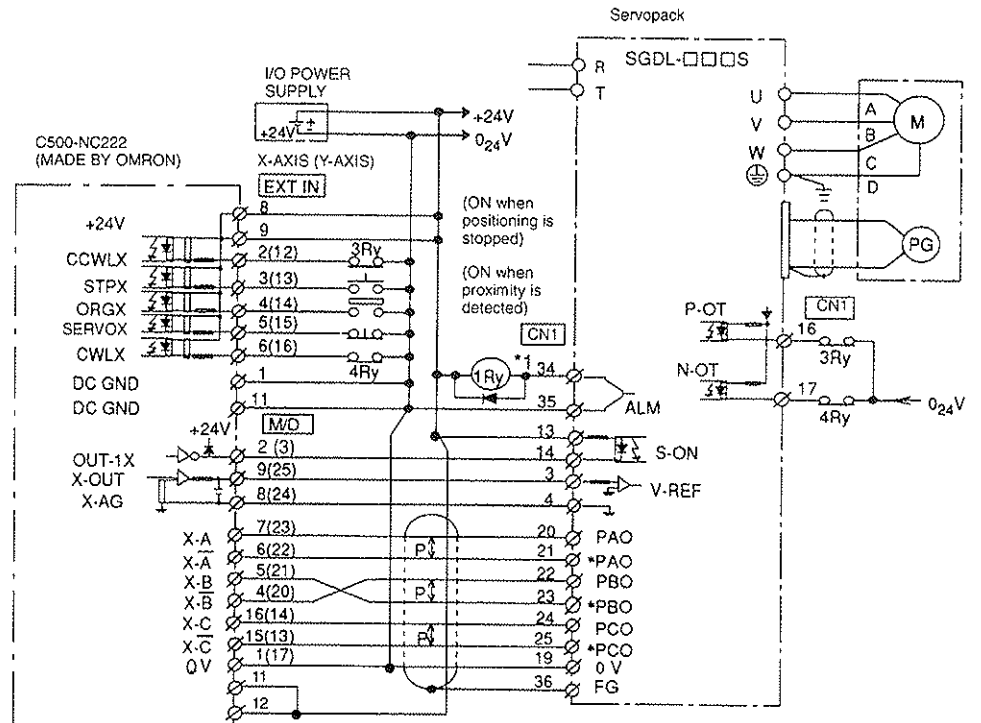

\*1 These signals are output for approximately two seconds when the power is turned ON. Take this into consideration when designing a power ON sequence. Relay 1Ry is used to stop main circuit power supply to Servopack.

**Note** The signals shown here are applicable only to OMRON Sequencer C500-NC221 and Yaskawa Servopack SGDL-□□□S.

5) Example of Connecting to MITSUBISHI Positioning Unit AD72

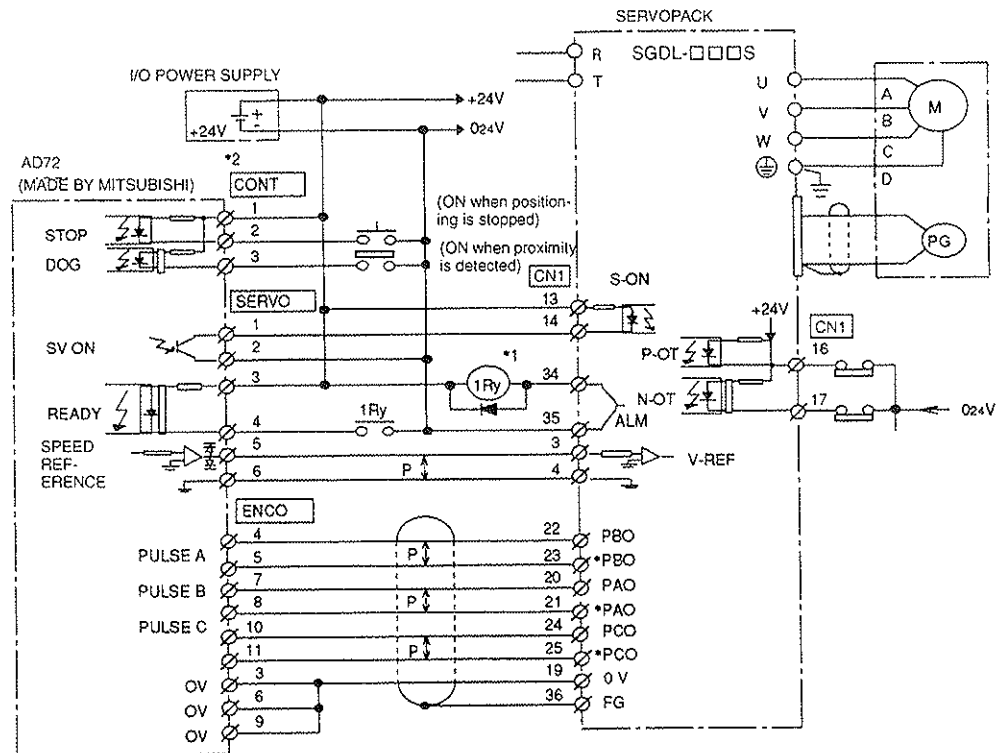

\*1 These signals are output for approximately two seconds when the power is turned ON. Take this into consideration when designing a power ON sequence. Relay 1Ry is used to stop main circuit power supply to Servopack.

\*2 These pin numbers are the same for both X and Y axes.

**Note** The signals shown here are applicable only to MITSUBISHI Sequencer AD72 and Yaskawa Servopack SGDL-□□□S.

1

## 1.4 Conducting a Test Run

This section describes how to conduct a full test run. The test run is divided into two steps. Complete a test run in step 1 first, then proceed to step 2.

1.4.1	Test Run in Two Steps .....	20
1.4.2	Step 1: Conducting a Test Run for Motor without Load .....	22
1.4.3	Step 2: Conducting a Test Run with the Motor Connected to the Machine .....	26
1.4.4	Supplementary Information on Test Run .....	28
1.4.5	Minimum User Constants Required and Input Signals .....	29

### 1.4.1 Test Run in Two Steps

Conduct the test run when wiring is complete.

Generally, conducting a test run for servo drives can be difficult. However, by following the two steps described below, the test run can be performed safely and correctly.

**NOTE** To prevent accidents, initially conduct a test run only for a servomotor under no load (i.e., with all couplings and belts disconnected). Do not run the servomotor while it is connected to a machine.

The test run is divided here into steps 1 and 2.

Complete the test run in step 1 first, then proceed to step 2. The purposes of each step are described on the next page.



**Step 1: Conducting a test run for the motor without load . . . . Check that the motor is wired correctly.**

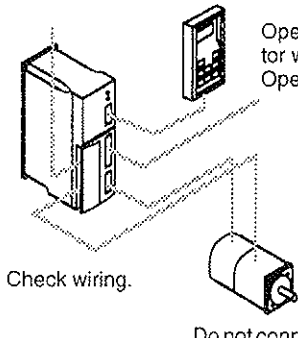

Operate the motor with a Digital Operator.

Check wiring.

Do not connect to a machine.

Conduct a test run with the motor shaft disconnected from the machine.

**Purpose:** To check power supply circuit wiring  
To check motor wiring  
To check I/O signal (CN1) wiring

**Outline:** Turn the power ON.  
Operate the motor with a digital operator.  
Check I/O signals (CN1).  
Conduct a test run using I/O signals.

**Step 2: Conducting a test run with the motor and machine connected . . . . . Adjust Servopack according to machine characteristics.**

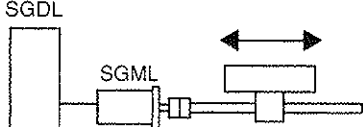

Adjust Servopack according to machine characteristics.

Connect to the machine and conduct a test run.

**Purpose:** To perform autotuning to adjust the motor according to machine characteristics  
To match the speed and direction of rotation with the machine specifications  
To check the final control mode

**Outline:** Perform autotuning.  
Adjust user constant settings.  
Record user constant settings.

End of test run

For customers who use a servomotor with a brake, refer to *Section 1.4.4 Supplementary Information on Test Run* before starting a test run.

The following pages describe the test run procedure in detail.

1

## 1.4.2 Step 1: Conducting a Test Run for Motor without Load

Check that the motor is wired correctly.

If the motor fails to rotate properly during a servo drive test run, the cause most frequently lies in incorrect wiring.

Conduct a test run for the motor without load according to the procedure described below. For customers who use a servomotor with brake, refer to *Section 1.4.4 Supplemental Information on Test Run* before starting a test run.

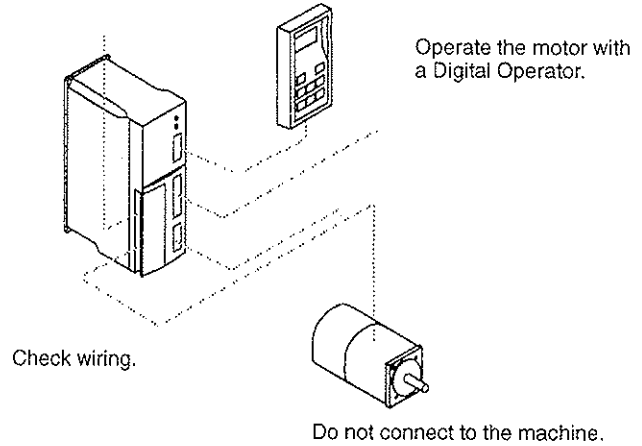

**(1) Secure the servomotor.**

Secure the servomotor to mounting holes to prevent it from moving during operation. Alternatively, install the servomotor on the machine and disconnect couplings and belts.

Secure servomotor to mounting holes.

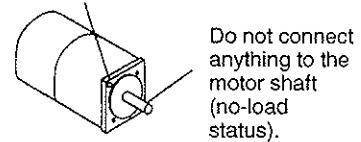

**(2) Disconnect connector CN1, then check the motor wiring in the power supply circuit. I/O signals (CN1) are not to be used so leave connector CN1 disconnected.**

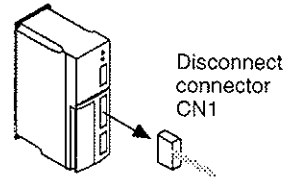

**(3) Short the alarm signal circuit.**

Because connector CN1 is disconnected, the alarm signal prevents the power supply circuit from being turned ON. Therefore, temporarily short the alarm signal circuit.

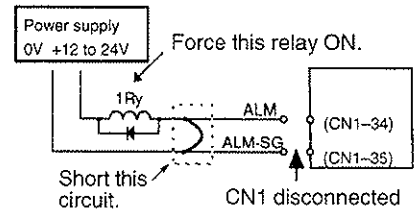

(4) Turn the power ON.

Turn the Servopack power ON. If the Servopack is turned ON normally, the LED on the Digital Operator lights up as shown in the figure.

Power is not supplied to the servomotor because the servo is OFF.

Normal display



Alternately displayed

Example of alarm display



Refer to Section 5.2 Troubleshooting.

If an alarm display appears on the LED as shown in the figure above, the power supply circuit, motor wiring or encoder wiring is incorrect. In this case, turn the power OFF, then correct the problem.

(5) Operate using the Digital Operator

Operate the motor with the Digital Operator. Check that the motor runs normally.

Refer to 3.2.2 Operating Using the Digital Operator.

Operation by Digital Operator

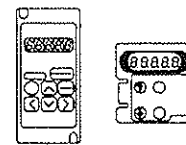

If an alarm occurs, the power supply circuit, motor wiring, or encoder wiring is incorrect.

(6) Connect signal lines.

Connect connector CN1 as follows:

- (1) Turn the power OFF.
- (2) Retrun the alarm signal circuit shorted in the above step (3) to its original state.
- (3) Connect connector CN1.
- (4) Turn the power ON again.

After turning the power OFF, remove the short circuit.

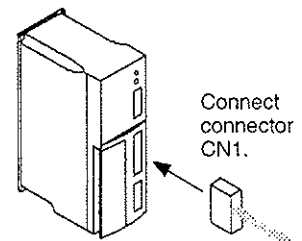

Connect connector CN1.

(7) Check input signals.

Check the input signal wiring in monitor mode. For the checking method, refer to 3.1.6 Operation in Monitor Mode.

Example of Un-05

Internal status bit display (Un-05, Un-06)



S-ON (CN1-14) P-CON (CN1-17) P-OT (CN1-16) N-OT (CN1-17)

The memory switch can be used to eliminate the need for external short-circuits in wiring (see pages 36 and 76).

## BASIC USES OF Σ-L SERIES PRODUCTS

### 1.4.2 Step 1: Conducting a Test Run for Motor without Load cont.

- Checking method

Turn each connected signal line ON and OFF to check that the monitor bit display changes accordingly.

Input Signal	ON/OFF	Monitor Bit Display
High level or open	OFF	Extinguished
0 V level	ON	Lit

If the signal lines below are not wired correctly, the motor fails to rotate. Always wire them correctly. (If signal lines are not to be used, short them as necessary.)

P-OT	CN1-16	Motor can rotate in forward direction when this input signal is at 0 V.
N-OT	CN1-17	Motor can reverse when this input signal is at 0 V.
S-ON	CN1-14	Servo is turned ON when this input signal is at 0 V. However, leave the servo in OFF status.

- (8) Turn servo (motor) ON.

Turn the servo ON as follows:

- (1) Check that no reference has been input.

PULS (CN1-1) and SIGN (CN1-3) are fixed.

- (2) Turn the servo ON signal ON.

Set S-ON (CN1-14) to 0 V. If normal, the motor is turned ON and the Digital Operator displays the data as shown in the figure. If an alarm display appears, take appropriate action as described in *Section 5.2 Troubleshooting*.

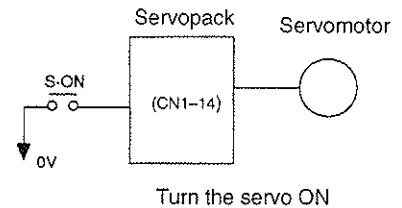

Display when servo is turned ON



- (9) Operate by reference input.

The operating procedures are as follows:

- (1) Gradually increase the speed reference input (V-REF, CN1-3) voltage. The motor will rotate.

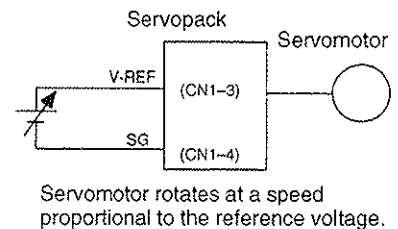

**When a host controller such as a programmable controller performs position control, it may be difficult to directly input the speed reference voltage. In this case, constant voltage reference should be input once to ensure correct operation.**

(2) Check the following items in monitor mode (see page 107):

- (1) Has a reference speed been input?
- (2) Is the motor speed as set?
- (3) Does the reference speed match the actual motor speed?
- (4) Does the motor stop when no reference is input?

Un-00	Actual motor speed
Un-01	Reference speed

(3) If the motor rotates at an extremely slow speed when 0 V is specified as the reference voltage, correct the reference offset value as described in *Section 3.2.7 Speed Reference Offset Automatic Adjustment*.

(4) To change motor speed or the direction of rotation, reset the user constants shown below.

Cn-03	Speed reference gain (see page 46)
Cn-02 bit 0	Reverse rotation mode (see page 34)

**If an alarm occurs or the motor fails to rotate during the above operation, connector CN1 wiring is incorrect or the user constant settings do not match the host controller specifications.**

**In this case, check the wiring and review the user constant settings, then repeat step 1.**

**Refer to *Appendix C List of User Constants*.**

This is all that is required to complete step 1 (conducting a test run for motor without load). Whenever possible, perform tuning associated with the host controller and other necessary adjustments in step 1 (before installing the motor on the machine).

### 1.4.3 Step 2: Conducting a Test Run with the Motor Connected to the Machine

After step 1 is complete, proceed to step 2 in which a test run is conducted with the motor connected to the machine. The purpose of step 2 is to adjust the Servopack according to the machine characteristics.

Conduct a test run according to the procedure described below.

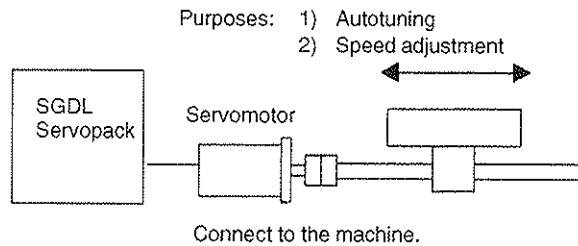

**NOTE** Before proceeding to step 2, repeat step 1 (conducting a test run for the motor without load) until you are fully satisfied that the test has been completed successfully. Operation faults that arise after the motor is connected to the machine not only damage the machine but may also cause an accident resulting in injury or death. Therefore, all items including user constants setting and wiring should be tested as conclusively as possible before step 1 is complete.

- (1) Check that power is OFF.  
Turn the Servopack power OFF.

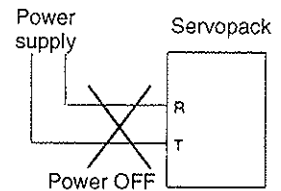

- (2) Connect the servomotor to the machine.  
Refer to 1.2.2 *Installing the Servomotor*.

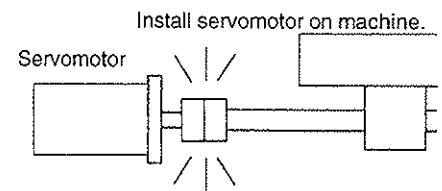

- (3) Perform autotuning.  
Tune the Servopack according to the machine characteristics. Refer to 3.2.3 *Autotuning*.

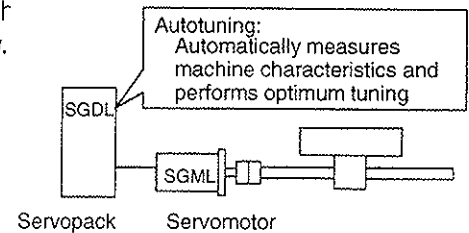

## (4) Operate by reference input.

As in step 1 (conducting a test run for motor without load), perform (9) *Operate by reference input* on page 24. Perform tuning associated with the host controller.

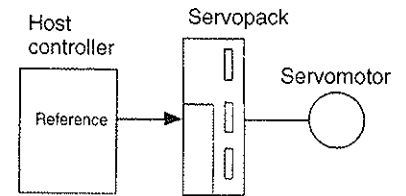

## (5) Set user constants and record the settings.

Set user constants as necessary. Record all the user constant settings for maintenance purposes.

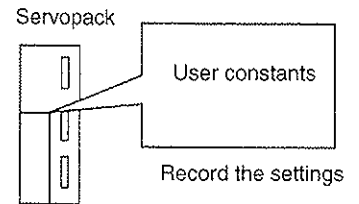

This is all that is required to conduct the test run.

Normally, the machine may cause much friction because of an insufficient running-in period. After a test run is complete, perform adequate running-in.

### 1.4.4 Supplementary Information on Test Run

When using a servomotor with a brake, always refer to the information described below before starting a test run:

#### 1) When using a servomotor with brake

The brake prevents the motor shaft from rotating due to a backdriving torque. Such a torque may be created by an external force or the force of gravity acting on the load and may result in undesired motion or the load, should motor power be lost.

Servopack uses the brake interlock output (BK) signal to control holding brake operation for a servomotor with brake.

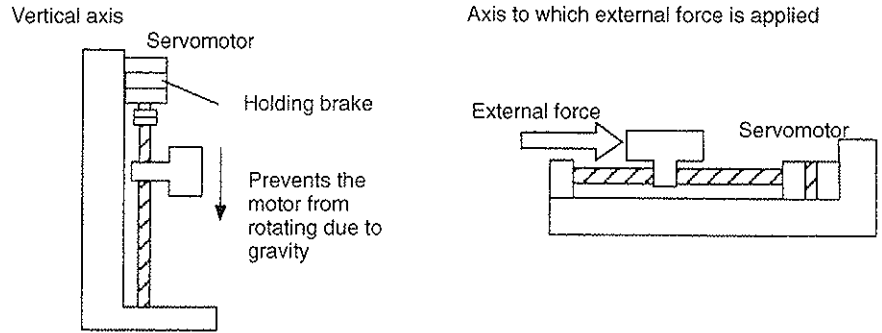

**NOTE** To prevent faulty operation caused by gravity (or external force), first check that the motor and holding brake operate normally with the motor disconnected from the machine. Then, connect the motor to the machine and conduct a test run.

For wiring of a servomotor with a brake, refer to *2.4.4 Using Holding Brake*.

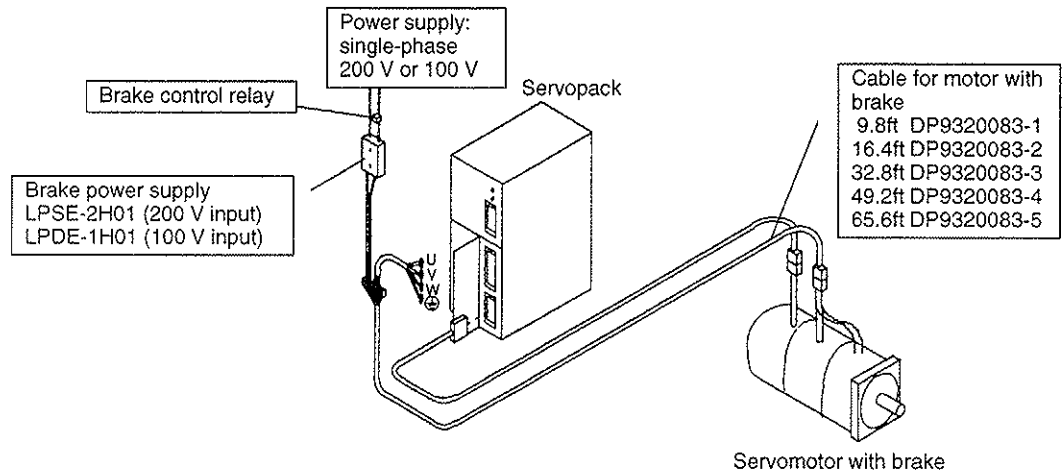



### 1.4.5 Minimum User Constants Required and Input Signals

- 1) This section describes the minimum user constants that must be set to conduct a test run. For details on how to set each user constant, refer to *3.1.5 Operation in User Constant Setting Mode*.

Cn-03	Speed reference adjustment gain
Cn-0A	Encoder pulse dividing ratio

- 2) If the specified direction of rotation differs from the actual direction of rotation, the wiring may be incorrect. In this case, recheck the wiring and correct it accordingly. Then, if the direction of rotation is to be reversed, set the following user constant:

Cn-02 (bit 0)	Reverse rotation mode (see page 34)
---------------	-------------------------------------

After changing the Cn-02 setting, always turn the power OFF, then ON. This makes the new setting valid.

- 3) The following table lists the minimum input signals required to conduct a test run. For details of each input signal, refer to the relevant page.

Signal Name	Pin Number	Function
$\overline{S-ON}$ (servo ON)	CN1-14	Switching between motor ON and OFF status. The memory switch can be used to eliminate the need for external short-circuit wiring (see page 76).
P-OT (forward rotation prohibited)	CN1-16	Overtravel limit switch The memory switch can be used to eliminate the need for external short-circuit wiring (see page 36).
N-OT (reverse rotation prohibited)	CN1-17	



# APPLICATIONS OF $\Sigma$ -L SERIES PRODUCTS

# 2

This chapter is prepared for readers who wish to learn more about the applications of  $\Sigma$ -L series products after fully understanding *Chapter 1 Basic Uses of  $\Sigma$ -L series Products*. It explains how to set user constants for each purpose and how to use each function. Read the applicable sections according to your requirements.

<b>2.1</b>	<b>Setting User Constants According to Machine Characteristics</b> .....	<b>34</b>
2.1.1	Changing the Direction of Motor Rotation .....	34
2.1.2	Setting the Overtravel Limit Function .....	35
2.1.3	Restricting Torque .....	36
<b>2.2</b>	<b>Setting User Constants According to Host Controller</b> .....	<b>43</b>
2.2.1	Inputting Speed Reference .....	43
2.2.2	Using Encoder Output .....	47
2.2.3	Using Contact I/O Signals .....	49
2.2.4	Using Contact Input Speed Control .....	51
2.2.5	Using Torque Control .....	55
2.2.6	Using Torque Restriction by Analog Voltage Reference .....	61
<b>2.3</b>	<b>Setting Up the <math>\Sigma</math>-L Servopack</b> .....	<b>62</b>
2.3.1	Using Autotuning Function .....	62
2.3.2	Setting Servo Gain .....	62
2.3.3	Setting the Torque Reference Filter Time Constant .....	63
2.3.4	Using the Soft Start Function .....	64
2.3.5	Using Proportional Control .....	64
2.3.6	Setting the Mode Switch Level .....	65
<b>2.4</b>	<b>Setting Stop Mode</b> .....	<b>67</b>
2.4.1	Adjusting Offset .....	67
2.4.2	Dynamic Brake .....	68
2.4.3	Using Zero-Clamp .....	68
2.4.4	Using Holding Brake .....	70

<b>2.5</b>	<b>Forming a Protective Sequence .....</b>	<b>72</b>
2.5.1	Using Servo Alarm Output and Alarm Code Output .....	72
2.5.2	Using Servo ON Input Signal .....	75
2.5.3	Using Running Output Signal .....	76
2.5.4	Handling of Power Failure .....	78
<b>2.6</b>	<b>Special Wiring .....</b>	<b>80</b>
2.6.1	Wiring Instructions .....	80
2.6.2	Wiring for Noise Control .....	82
2.6.3	Using More Than One Servo Drive .....	87
2.6.4	Using Regenerative Units .....	88
2.6.5	Using SGDL Servopack with High Voltage Line .....	91
2.6.6	Connector Terminal Layouts .....	93

## Before Reading this Chapter

- 1) This chapter describes how to use each CN1 connector I/O signal for the SGDL Servopack and how to set the corresponding user constant.
- 2) For a list of I/O signals of CN1 connector, refer to *Appendix B List of I/O Signals*.  
For terminal arrangement for I/O signals of CN1 connector, refer to *2.6.6 Connector Terminal Layouts*.

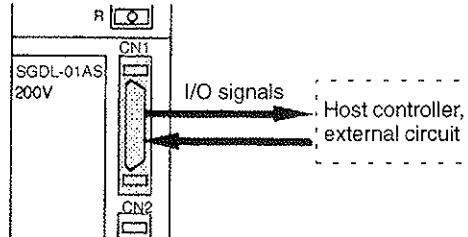

- 3) For a list of user constants, refer to *Appendix C List of User Constants*.
- 4) User constants are divided into the following two types.

1) Memory switch Cn-01 and Cn-02	Set each bit to ON or OFF to select a function.
2) Constant setting Cn-03 and later	Set a numerical value such as speed loop gain.

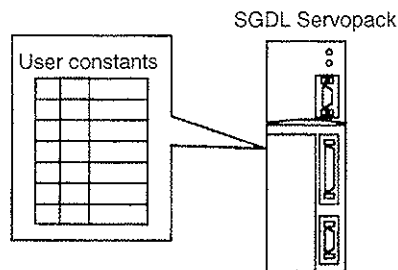

- 5) For details on how to set user constants, refer to *3.1.5 Operation in User Constant Setting Mode*.

## 2.1 Setting User Constants According to Machine Characteristics

This section describes how to set user constants according to the dimensions and performance of the machine to be used.

2.1.1	Changing the Direction of Motor Rotation .....	34
2.1.2	Setting the Overtravel Limit Function .....	35
2.1.3	Restricting Torque .....	36

### 2.1.1 Changing the Direction of Motor Rotation

- 1) This Servopack provides a reverse rotation mode in which the direction of rotation can be reversed without altering the servomotor wiring. With the standard setting, forward rotation is defined as counterclockwise (CCW) when viewed from the drive end.
- 2) If reverse rotation mode is used, the direction of motor rotation can be reversed without other items being changed. The direction (+/-) of axial motion is reversed.

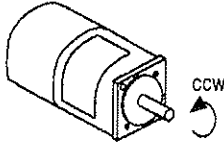
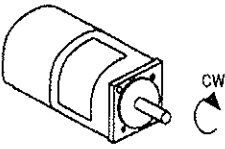
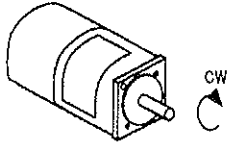
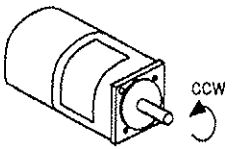
	Standard Setting	Reverse Rotation Mode
Forward Run Reference		
Reverse Run Reference		

#### 3) Setting Reverse Rotation Mode:

Set bit 0 of memory switch Cn-02 to select reverse rotation mode.

Cn-02 Bit 0	Rotation Direction Selection	Factory Setting: 0
-------------	------------------------------	--------------------

Set the direction of rotation.

Setting	Meaning
0	Forward rotation is defined as counterclockwise rotation when viewed from the drive end. (Standard setting)
1	Forward rotation is defined as clockwise rotation when viewed from the drive end. (Reverse rotation mode)

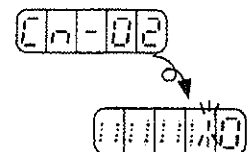

## 2.1.2 Setting the Overtravel Limit Function

- 1) The overtravel limit function forces the moving part of the machine to stop when it exceeds the movable range. Use the dynamic brake to force the motor to stop.
- 2) To use the overtravel limit function, connect the following input signal terminals correctly.

→ Input P-OT CN1-16	Forward Rotation Prohibited (Forward Overtravel)
→ Input N-OT CN1-17	Reverse Rotation Prohibited (Reverse Overtravel)

Inputs terminals for overtravel limit switch.

For linear motion, connect a limit switch to prevent damage to the machine.

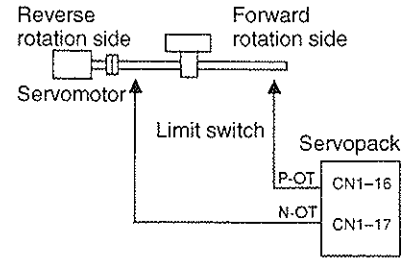

P-OT	ON: CN1-16 is at low level.	Forward rotation allowed. Normal operation status.
	OFF: CN1-16 is at high level.	Forward rotation prohibited (reverse rotation allowed).
N-OT	ON: CN1-17 is at low level.	Reverse rotation allowed. Normal operation status.
	OFF: CN1-17 is at high level.	Reverse rotation prohibited (forward rotation allowed).

3) Use the following user constants (memory switch) to specify whether input signals for overtravel are to be used.

Cn-01 Bit 2	Use of P-OT Input Signal	Factory Setting: 0
Cn-01 Bit 3	Use of N-OT Input Signal	Factory Setting: 0

Specifies whether the P-OT input signal for prohibiting forward rotation at overtravel (CN1-16) is to be used and whether the N-OT input signal for prohibiting reverse rotation at overtravel (CN1-17) is to be used.

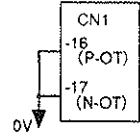

Specifies "1" when external short-circuit wiring is to be omitted.

The short-circuit wiring shown in the figure can be omitted when P-OT and N-OT are not used.

Bit	Setting	Meaning
Bit 2	0	Uses the P-OT input signal for prohibiting forward rotation. (Forward rotation is prohibited when CN1-16 is open. Forward rotation is allowed when CN1-16 is at 0 V.)
	1	Does not use the P-OT input signal for prohibiting forward rotation. (Forward rotation is always allowed. This has the same effect as shorting CN1-16 to 0 V.)
Bit 3	0	Uses the N-OT input signal for prohibiting reverse rotation. (Reverse rotation is prohibited when CN1-17 is open. Reverse rotation is allowed when CN1-17 is at 0 V.)
	1	Does not use the N-OT input signal for prohibiting reverse rotation. (Reverse rotation is always allowed. This has the same effect as shorting CN1-17 to 0 V.)

### 2.1.3 Restricting Torque

1) The Servopack can provide the following torque control:

- Torque restriction
  - Level 1: To restrict the maximum output torque to protect the machine or workpiece
  - Level 2: To restrict torque after the motor moves the machine to a specified position
- Torque control
  - Level 3: To always control output torque, not speed
  - Level 4: To alternately use speed control and torque control

This section describes how to use levels 1 and 2 of the torque restriction function.



## 2) How to Set Level 1: Internal Torque Limit

The maximum torque is restricted to the values set in the following user constants.

<b>Cn-08</b>	TLMTF Forward Rotation Torque Limit	Unit: %	Setting Range: 0 to Maximum Torque	Factory Setting: Maximum Torque
<b>Cn-09</b>	TLMTR Reverse Rotation Torque Limit	Unit: %	Setting Range: 0 to Maximum Torque	Factory Setting: Maximum Torque

Sets the maximum torque values for forward rotation and reverse rotation, respectively.

Sets these user constants when torque must be restricted according to machine conditions.

This torque restriction function always monitors torque, and outputs the signal shown on the right when the limit value is reached.

Specifies a torque limit value in terms of a percentage of the rated torque.

### Output Signal for Torque Restriction Function

- $\overline{\text{TGON}}$  (CN1-9)
- Status indication mode bit data
- Monitor mode (Un-05) bit 4

User Constant Setting:  
Memory switch (Cn-01) bit 4 = 1

### Example of Use: Machine Protection

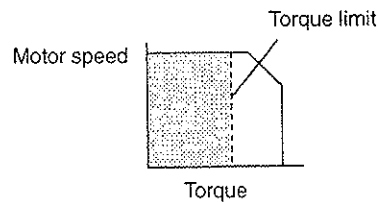

Note that too small a torque limit value will result in torque shortage at acceleration or deceleration.

### • Using $\overline{\text{TGON}}$ Signal

This section describes how to use contact output signal  $\overline{\text{TGON}}$  as a torque limit output signal.

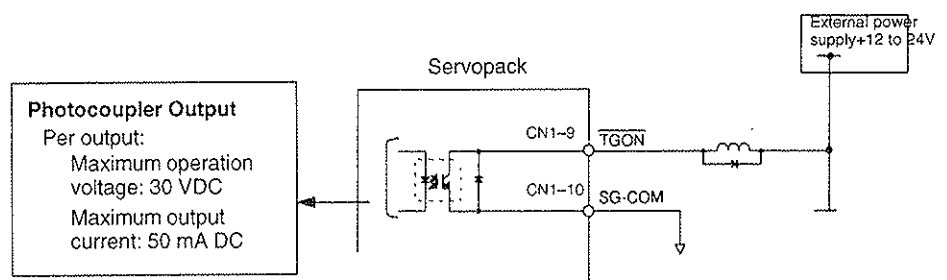

<b>Output → TGON CN1-9</b>	Torque Limit Output (Running Output)
----------------------------	--------------------------------------

This signal indicates whether motor output torque (current) is being restricted.

ON status: The circuit between CN1-9 and CN1-10 is closed. CN1-9 is at low level.	Motor output torque is being restricted. (Internal torque reference is greater than the preset value.)
OFF status: The circuit between CN1-9 and CN1-10 is open. CN1-9 is at high level.	Motor output torque is not being restricted. (Internal torque reference is equal to or below the preset value.)

- Preset Value: Cn-08 (TLMTF)  
 Cn-09 (TLMTR)  
 Cn-18 (CLMIF) : P-CL input only  
 Cn-19 (CLMIR) : N-CL input only

**Note** This function is changed to another function depending on the setting of bit 4 of memory switch Cn-01.

To use output signal  $\overline{\text{TGON}}$  as a torque limit output signal, set the following memory switch to 1.

This memory switch can also be used to set level 2 torque restriction (described in the next subsection).

Cn-01 Bit 4	$\overline{\text{TGON}}$ Output Signal Selection	Factory Setting: 0
-------------	--	--------------------

Sets the output conditions for output signal  $\overline{\text{TGON}}$  (CN1-9).

Setting	Meaning				
0	<p>Uses <math>\overline{\text{TGON}}</math> output signal as a running output signal.</p> <p>Compares the motor speed with the Cn-0B (TGONLV) setting.</p> <table border="1"> <tr> <td>Motor speed <math>\geq</math> preset value</td> <td>Closes the circuit between CN1-9 and CN1-10</td> </tr> <tr> <td>Motor speed &lt; preset value</td> <td>Opens the circuit between CN1-9 and CN1-10</td> </tr> </table>	Motor speed $\geq$ preset value	Closes the circuit between CN1-9 and CN1-10	Motor speed < preset value	Opens the circuit between CN1-9 and CN1-10
Motor speed $\geq$ preset value	Closes the circuit between CN1-9 and CN1-10				
Motor speed < preset value	Opens the circuit between CN1-9 and CN1-10				
1	<p>Uses <math>\overline{\text{TGON}}</math> output signal as a torque limit output signal.</p> <p>Compares the SGDL Servopack internal torque (current) reference with the preset value.</p> <p>Preset Value: Cn-08 (TLMTF) Cn-09 (TLMTR) Cn-18 (CLMIF): P-CL input only Cn-19 (CLMIR): N-CL input only</p> <table border="1"> <tr> <td>Internal torque (current) reference <math>\geq</math> preset value</td> <td>Opens the circuit between CN1-9 and CN1-10</td> </tr> <tr> <td>Internal torque (current) reference &lt; preset value</td> <td>Closes the circuit between CN1-9 and CN1-10</td> </tr> </table>	Internal torque (current) reference $\geq$ preset value	Opens the circuit between CN1-9 and CN1-10	Internal torque (current) reference < preset value	Closes the circuit between CN1-9 and CN1-10
Internal torque (current) reference $\geq$ preset value	Opens the circuit between CN1-9 and CN1-10				
Internal torque (current) reference < preset value	Closes the circuit between CN1-9 and CN1-10				

Bit 4 of memory switch Cn-01

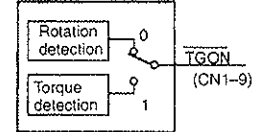

When  $\overline{\text{TGON}}$  output signal is changed, the following bit data are also changed:

- Status indication mode bit data
- Monitor mode Un-05 bit 4

3) How to Set Level 2: External Torque Limit

First, use a contact input signal to make the torque (current) limit value set in the user constant valid. Torque limit can be set separately for forward and reverse rotation.

To use this function, always set bit 2 of memory switch Cn-02 to 0 (standard setting). The contact input speed control function cannot be used.

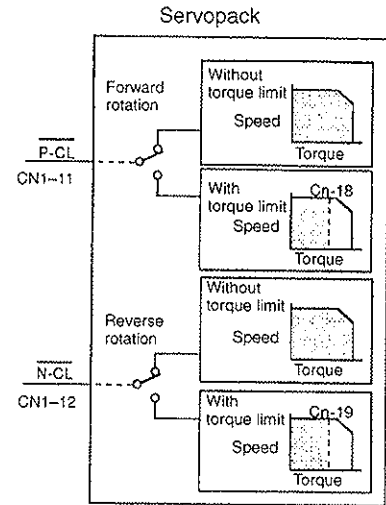

P-CL	ON: CN1-11 is at low level.	Torque restriction applies during forward rotation.	Limit value: Cn-18
	OFF: CN1-11 is at high level.	Torque restriction does not apply during forward rotation.	
N-CL	ON: CN1-12 is at low level.	Torque restriction applies during reverse rotation.	Limit value: Cn-19
	OFF: CN1-12 is at high level.	Torque restriction does not apply during reverse rotation.	

This torque restriction function outputs the signal shown on the right.

Output Signal for Torque Restriction Function

- TGON (CN1-9)
- Status indication mode bit data
- Monitor mode Un-05 bit 4

User Constant Setting:  
Memory switch Cn-01 bit 4 = 1

Examples of Use:

- Forced stopping
- Holding workpiece by robot

Sets a torque limit value when torque is restricted by external contact input.

This function is valid when bit 2 of memory switch Cn-02 is set to 0.

<b>Cn-18</b>	CLMIF Forward External Torque Limit	Unit: %	Setting Range: 0 to Maximum Torque	Factory Setting: 100
<b>Cn-19</b>	CLMIR Reverse External Torque Limit	Unit: %	Setting Range: 0 to Maximum Torque	Factory Setting: 100

When $\overline{\text{P-CL}}$ (CN1-11) is input	Applies torque restriction as specified in Cn-18
When $\overline{\text{N-CL}}$ (CN1-12) is input	Applies torque restriction as specified in Cn-19

For torque restriction by analog voltage reference, refer to 2.2.6 Using Torque Restriction by Analog Voltage Reference.

• Using  $\overline{\text{P-CL}}$  and  $\overline{\text{N-CL}}$  Signals

This section describes how to use input signals  $\overline{\text{P-CL}}$  and  $\overline{\text{N-CL}}$  as torque limit input signals.

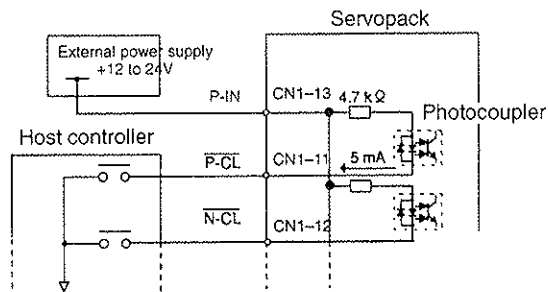

→ <b>Input <math>\overline{\text{P-CL}}</math> CN1-11</b>	Forward External Torque Limit Input (Speed Selection 1)
→ <b>Input <math>\overline{\text{N-CL}}</math> CN1-12</b>	Reverse External Torque Limit Input (Speed Selection 2)

These signals are for forward and reverse external torque (current) limit input.

This function is useful in forced stopping.

**Output Signal for Torque Restriction Function**

- $\overline{\text{TGON}}$  (CN1-9)
  - Status indication mode bit data
  - Monitor mode Un-05 bit 4
- User Constant Setting:  
Memory switch Cn-01 bit 4 = 1

## APPLICATIONS OF Σ-L SERIES PRODUCTS

### 2.1.3 Restricting Torque cont.

P-CL	ON: CN1-11 is at low level.	Torque restriction applies during forward rotation.	Limit value: Cn-18
	OFF: CN1-11 is at high level.	Torque restriction does not apply during forward rotation. Normal operation status.	
N-CL	ON: CN1-12 is at low level.	Torque restriction applies during reverse rotation.	Limit value: Cn-19
	OFF: CN1-12 is at high level.	Torque restriction does not apply during reverse rotation. Normal operation status.	

The signal shown on the right is output while torque is being restricted.

**Note** This function is changed to another function depending on the setting of bit 2 of memory switch Cn-02 (see below).

To use input signals  $\overline{P-CL}$  and  $\overline{N-CL}$  as torque limit input signals, set the following memory switch to 0.

<b>Cn-02 Bit 2</b>	Contact Input Speed Control Selection	Factory Setting: 0
--------------------	---------------------------------------	--------------------

Prohibits the contact input speed control function.

If the contact input speed control function is used, the contents of the input signals shown below will change.

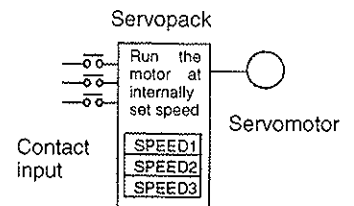

After this memory switch is reset, the meanings of the following signals will also change:

Monitor mode (Un-05) bit 7 and bit 8

Setting	Meaning	Input Signal			
0	Does not use the contact input speed control function.	$\overline{P-CON}$ (CN1-15) Used to switch between P control and PI control. (For speed/torque control, bits A and B of Cn-01 take precedence over this signal.)			
		$\overline{P-CL}$ (CN1-11) Used for forward external torque limit input			
		$\overline{N-CL}$ (CN1-12) Used for reverse external torque limit input			
1	Uses the contact input speed control function.	0: OFF, 1: ON			
		<b>P-CON</b>	<b>P-CL</b>	<b>N-CL</b>	<b>Speed Setting</b>
		Direction of rotation 0: Forward 1: Reverse	0	0	Normal speed/torque or position control
			0	1	Cn-1F (SPEED1)
			1	1	Cn-20 (SPEED2)
1	0		Cn-21 (SPEED3)		

- Handling of the  $\overline{TGON}$  signal is the same as for level 1 (internal torque limit). Refer to *Using TGON Signal* on page 37.

## 2.2 Setting User Constants According to Host Controller

This section describes how to connect a  $\Sigma$ -L series Servo to a host controller and how to set user constants.

2.2.1	Inputting Speed Reference .....	43
2.2.2	Using Encoder Output .....	47
2.2.3	Using Contact I/O Signals .....	49
2.2.4	Using Contact Input Speed Control .....	51
2.2.5	Using Torque Control .....	55
2.2.6	Using Torque Restriction by Analog Voltage Reference .....	61

2

### 2.2.1 Inputting Speed Reference

- Input a speed reference by using the following input signal "speed reference input." Since this signal can be used in different ways, set the optimum reference input for the system to be created.

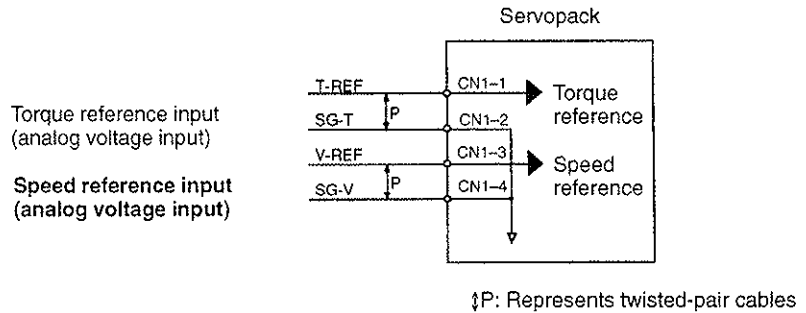

→ Input V-REF	CN1-3	Speed Reference Input
→ Input SG-V	CN1-4	Signal Ground for Speed Reference Input

Use these signals when speed control is selected (bits A and B of memory switch Cn-01).

For ordinary speed control, always wire the V-REF and SG-V terminals.

Motor speed is controlled in proportion to the input voltage between V-REF and SG-V.

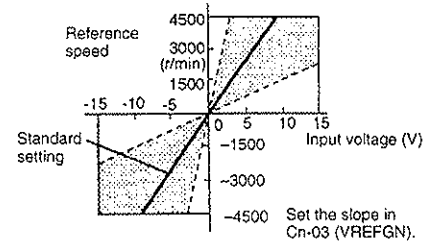

## APPLICATIONS OF Σ-L SERIES PRODUCTS

### 2.2.1 Inputting Speed Reference cont.

- Standard Setting:

Cn-03 = 500: This setting means that 6 V is equivalent to rated speed (3,000 r/min)

Examples:

+6 V input → 3000 r/min in forward direction

+1 V input → 500 r/min in forward direction

-3 V input → 1500 r/min in reverse direction

User constant Cn-03 can be used to change the voltage input range.

- Example of Input Circuit  
(See the figure on the right)

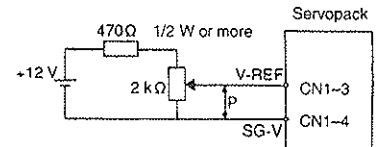

For noise control, always use twisted-pair cables.

Recommended Variable Resistor for Speed Setting:

Type 25HP-10B manufactured by Sakae Tsushin Kogyo Co., Ltd.

When position control is performed by a host controller such as a programmable controller.

Connect V-REF and SG-V to speed reference output terminals on the host controller. In this case, adjust Cn-03 according to output voltage specifications.

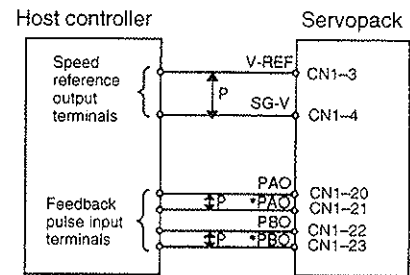

⇄P: Represents twisted-pair cables

2) Use the memory switch and input signal  $\overline{P-CON}$  to specify one of the four modes shown below.

Cn-01 Bit A	Control Mode Selection	Factory Setting: 0
Cn-01 Bit B	Control Mode Selection	Factory Setting: 0

The Servopack for speed/torque control (SGDL-□□□S) provides four different control modes.



Cn-01 Setting		Control Mode					
Bit B	Bit A						
0	0	<p><b>Speed Control</b></p> <p>This is normal speed control.</p> <ul style="list-style-type: none"> <li>Speed reference is input from V-REF (CN1-3).</li> <li>P-CON (CN1-15) signal is used to switch between P control and PI control.</li> </ul> <table border="1"> <tr> <td>CN1-15 is open</td> <td>PI control</td> </tr> <tr> <td>CN1-15 is at 0 V</td> <td>P control</td> </tr> </table> <ul style="list-style-type: none"> <li>Torque reference input T-REF (CN1-1) cannot be used.</li> </ul>	CN1-15 is open	PI control	CN1-15 is at 0 V	P control	<p>SGDL Servopack</p>
CN1-15 is open	PI control						
CN1-15 is at 0 V	P control						
0	1	<p><b>Zero-clamp Speed Control</b></p> <p>This speed control allows the zero-clamp function to be set when the motor stops.</p> <ul style="list-style-type: none"> <li>Speed reference is input from V-REF (CN1-3).</li> <li>P-CON (CN1-15) signal is used to turn the zero-clamp function ON or OFF.</li> </ul> <table border="1"> <tr> <td>CN1-15 is open</td> <td>Turns zero-clamp function OFF</td> </tr> <tr> <td>CN1-15 is at 0 V</td> <td>Turns zero-clamp function ON</td> </tr> </table> <ul style="list-style-type: none"> <li>Torque reference input T-REF (CN1-1) cannot be used.</li> </ul>	CN1-15 is open	Turns zero-clamp function OFF	CN1-15 is at 0 V	Turns zero-clamp function ON	<p>SGDL Servopack</p> <p><b>Zero-clamp is performed when the following two conditions are met:</b>  <b>Condition 1: P-CON is turned ON.</b>  <b>Condition 2: Motor speed drops below the preset value.</b>  <b>Preset value: Cn-0F (ZCLVL)</b></p>
CN1-15 is open	Turns zero-clamp function OFF						
CN1-15 is at 0 V	Turns zero-clamp function ON						
1	0	Torque control I					
1	1	Torque control II					

For torque control, refer to 2.2.5 Using Torque Control.

- Using  $\overline{\text{P-CON}}$  Signal:

→ **Input P-CON CN1-15** Proportional Control, etc.

The function of input signal  $\overline{\text{P-CON}}$  changes with the memory switch setting.

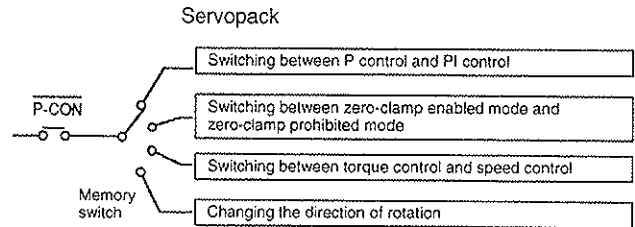

Memory Switch			Meaning of P-CON Signal
Cn-02 Bit 2	Cn-01 Bit B	Cn-01 Bit A	
0	0	0	Switching between proportional (P) control and proportional/integral (PI) control
0	0	1	Switching between zero-clamp enabled/prohibited mode
0	1	0	Not used
0	1	1	Switching between torque control and speed control
1	-	-	Changing the direction of rotation during contact input speed control

- 3) Adjust the speed reference gain using the following user constant.

<b>Cn-03</b>	VREFGN Speed Reference Gain	Unit: (r/min)/V	Setting Range: 0 to 2162	Factory Setting: 500
--------------	-----------------------------	--------------------	-----------------------------	----------------------------

Sets the voltage range for speed reference input V-REF (CN1-3). Sets this user constant according to the output form of the host controller or external circuit.

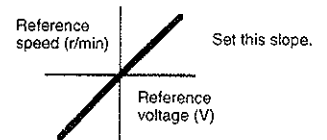

The factory setting is as follows:  
 Rated speed (3000 r/min)/6 V = 500



### Zero-clamp function

This function is used for a system in which the host controller does not form a position loop. In this case, the stopping position may shift even if a speed reference is set to 0. If the zero-clamp function is turned ON, a position loop is internally formed so that the stopping position is firmly "clamped."

## 2.2.2 Using Encoder Output

- Encoder output signals **divided** inside the Servopack can be output externally. These signals can be used to form a position control loop in the host controller.

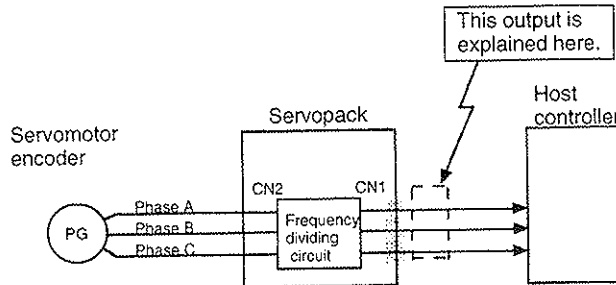

The output circuit is for line driver output. Connect each signal line according to the following circuit diagram.

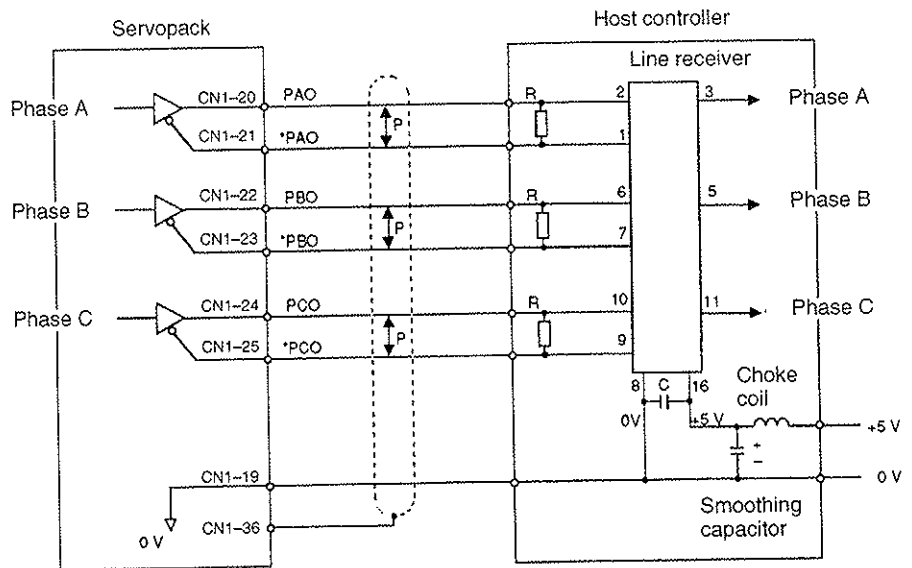

‡P: Represents twisted-pair cables

Line receiver used: SN75175 manufactured by Texas Instruments inc. or MC3486 (or equivalent)

R (termination resistor): 220 to 470 Ω

C (decoupling capacitor): 0.1 μF



### Divided (or dividing)

"Dividing" means converting an input pulse train from the encoder mounted on the motor according to the preset pulse density and outputting the converted pulse. The unit is pulses per revolution.

2) I/O signals are described below.

<b>Output → PAO CN1-20</b>	Encoder Output Phase-A
<b>Output → * PAO CN1-21</b>	Encoder Output Phase-A
<b>Output → PBO CN1-22</b>	Encoder Output Phase-B
<b>Output → * PBO CN1-23</b>	Encoder Output Phase-B
<b>Output → PCO CN1-24</b>	Encoder Output Phase-C
<b>Output → * PCO CN1-25</b>	Encoder Output Phase-C

Divided encoder signals are output.

Always connect these signal terminals when a position loop is formed in the host controller to perform position control.

Set a dividing ratio in the following user constant.

<b>Dividing ratio setting</b>	Cn-0A PGRAT
-------------------------------	-------------

**Output Phase Form**

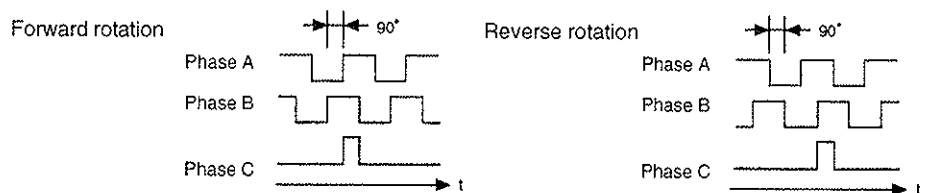

<b>Output → SG CN1-19</b>	Signal Ground for Encoder Output
<b>Output → FG CN1-36</b>	Frame Ground

SG: Connect to 0 V on the host controller.

FG: Connect to the cable shielded wire.

3) Set the pulse dividing ratio in the following user constant.

<b>Cn-0A</b>	PGRAT Encoder Pulse Dividing Ratio Setting	Unit: P/R	Setting Range: 16 to No. of Encoder Pulses	Factory Setting: 1024
--------------	---	-----------	---	-----------------------------

Sets the number of output pulses for PG output signals (PAO, \*PAO, PBO and \*PBO).

Pulses from motor encoder (PG) are divided by the preset number of pulses before being output.

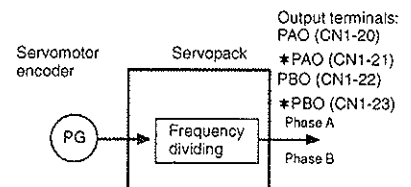

The number of output pulses per revolution is set in this user constant. Set this value according to the reference unit of the machine or controller to be used.

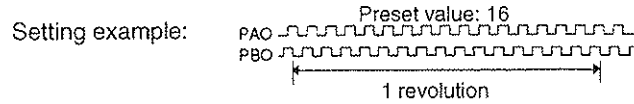

## 2.2.3 Using Contact I/O Signals

### 1) Contact Input Signal Terminal Connections

These signals are used to control SGDL Servopack operation. Connect these signal terminals as necessary.

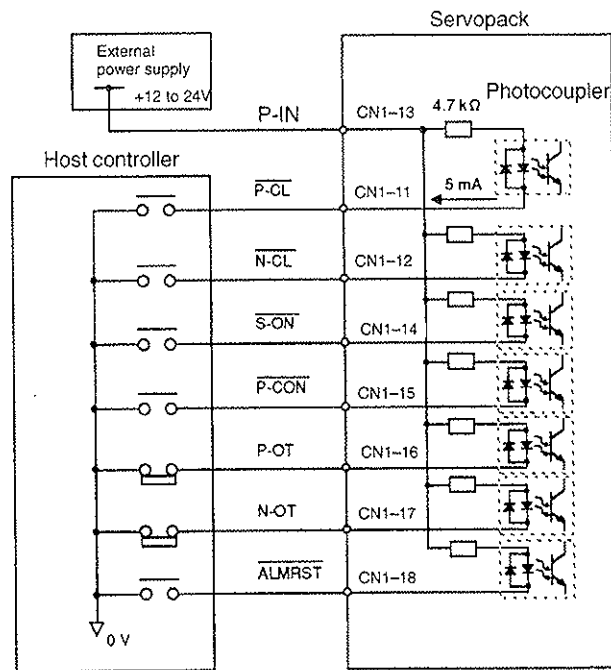

**Note** Provide an external power supply separately.  
There are no power terminals to which the SGDL Servopack outputs signals externally.

External Power Supply: +12 to 24 VDC  
50 mA or more

Yaskawa recommends that this external power supply be the same type as for the output circuit.

→ Input P-IN CN1-13

External Power Supply

This external power supply input terminal is common to the following contact input signals:

Contact Input Signals:	$\overline{P-CL}$	(CN1-11)
	$\overline{N-CL}$	(CN1-12)
	$\overline{S-ON}$	(CN1-14)
	$\overline{P-CON}$	(CN1-15)
	$\overline{P-OT}$	(CN1-16)
	$\overline{N-OT}$	(CN1-17)
	$\overline{ALMRST}$	(CN1-18)

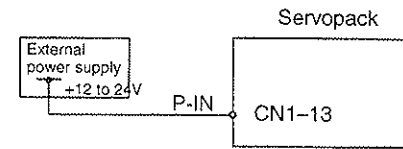

Connect an external power supply.

2) Contact Output Signal Terminal Connections

These output signals are used to indicate SGDL Servopack operation status.

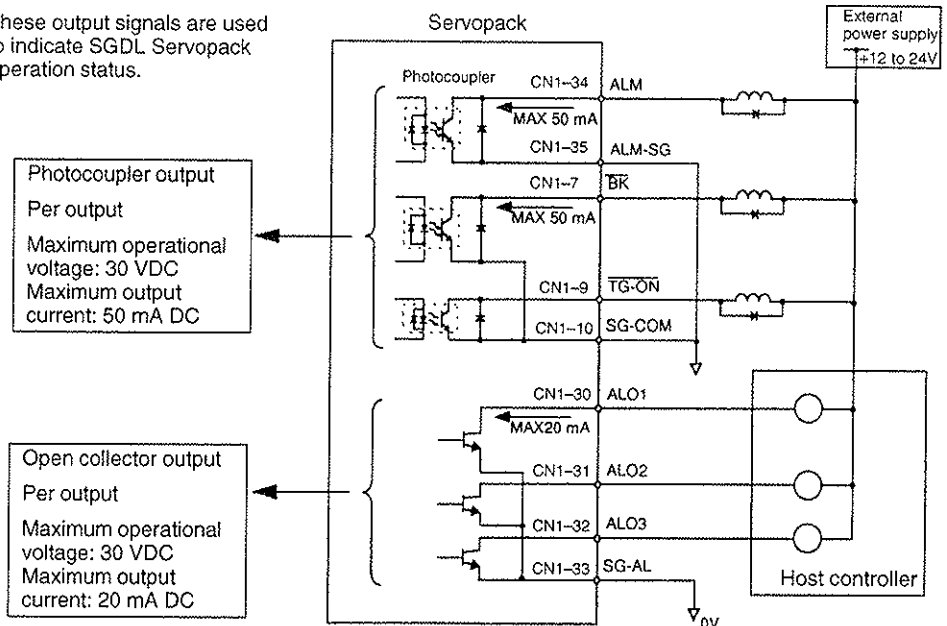

Photocoupler output  
Per output  
Maximum operational voltage: 30 VDC  
Maximum output current: 50 mA DC

Open collector output  
Per output  
Maximum operational voltage: 30 VDC  
Maximum output current: 20 mA DC

**Note** Provide an external power supply separately.  
There are no power terminals to which the SGDL Servopack outputs signals externally.  
Yaskawa recommends that this external power supply be the same type as for the input circuit.

Output → SG-COM CN1-10

Output Signal Ground Common

This signal ground is used for the following output signals. Connect to 0 V on the external power supply.

Contact Output Signals:	$\overline{BK}$	(CN1-7)
	$\overline{TGON}$	(CN1-9)

## 2.2.4 Using Contact Input Speed Control

- 1) The contact input speed control function provides easy-to-use speed control. It allows the user to initially set three different motor speeds in user constants, select one of the speeds externally by contact input and run the motor.

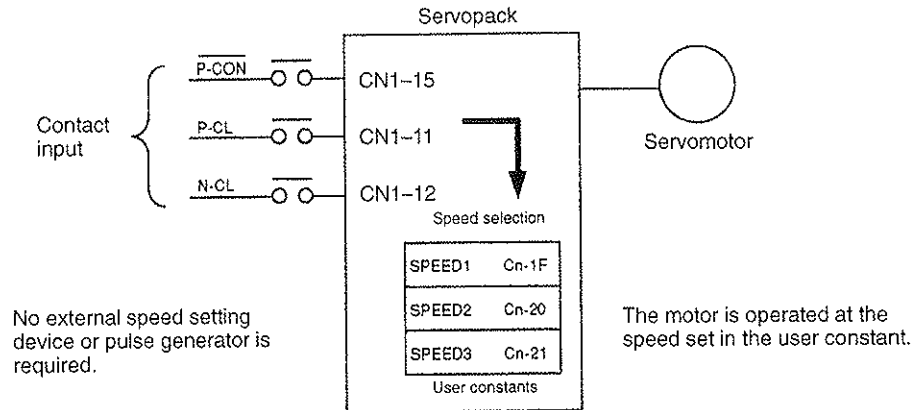

- 2) To use the contact input speed control function, perform Steps a) to c).

- a) Set the following memory switch to 1.

Cn-02 Bit 2	Contact Input Speed Control Selection	Factory Setting: 0
-------------	---------------------------------------	--------------------

Enables the contact input speed control function.

If the contact input speed control function is used, the contents of the input signals shown below will change.

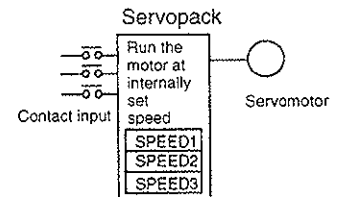

When this memory switch is reset, the meanings of the following signals will also change:

**Monitor mode (Un-05) bit 7 and bit 8**

Setting	Meaning	Input Signal				
0	Does not use the contact input speed control function.	P-CON(CN1-15)		Used to switch between P control and PI control.		
		P-CL(CN1-11)		Used for forward external current limit input		
		N-CL(CN1-12)		Used for reverse external current limit input		
1	Uses the contact input speed control function.	0: OFF, 1: ON				
		P-CON	P-CL	N-CL	Speed Setting	
		Direction of rotation	0	0	Stop (or pulse reference)	
			0	1	Cn-1F, SPEED1	
		0: Forward 1: Reverse	1	1	Cn-20, SPEED2	
1	0		Cn-21, SPEED3			

b) Set three motor speeds in the following user constants.

Cn-1F	SPEED1 1st Speed (Contact Input Speed Control)	Unit: r/min	Setting Range: 0 to Maximum Speed	Factory Setting: 100
Cn-20	SPEED2 2nd Speed (Contact Input Speed Control)	Unit: r/min	Setting Range: 0 to Maximum Speed	Factory Setting: 200
Cn-21	SPEED3 3rd Speed (Contact Input Speed Control)	Unit: r/min	Setting Range: 0 to Maximum Speed	Factory Setting: 300

Use these user constants to set motor speeds when the contact input speed control function is used (set bit 2 of memory switch Cn-02).

Speed selection input signals  $\overline{P-CL}$  (CN1-11) and  $\overline{N-CL}$  (CN1-12), and rotation direction selection signal P-CON (CN1-15) enable the motor to run at the preset speeds.

Contact input speed control  
(Memory switch Cn-02 bit 2 = 1)

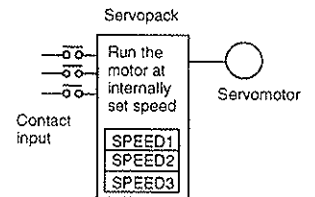

c) Set the soft start time.

Cn-07	SFSACC Soft Start Time (Acceleration)	Unit: ms	Setting Range: 0 to 10000	Factory Setting: 0
Cn-23	SFSDEC Soft Start Time (Deceleration)	Unit: ms	Setting Range: 0 to 10000	Factory Setting: 0

In the Servopack, a speed reference is multiplied by the preset acceleration or deceleration value to provide speed control.

When a progressive speed reference is input or contact input speed control is used, smooth speed control can be performed. (For normal speed control, set "0" in each user constant.)

Set the following value in each user constant.

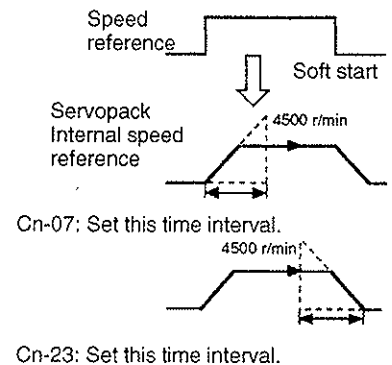

- Cn-07: Time interval from the time the motor starts until it reaches the maximum speed (4500 r/min)
- Cn-23: Time interval from the time the motor is running at the maximum speed until it stops



3) Contact input speed control performs the following operation.

The following input signals are used to start and stop the motor.

→ Input $\overline{\text{P-CL}}$ CN1-11	Speed Selection 1 (Forward External Torque Limit Input)
→ Input $\overline{\text{N-CL}}$ CN1-12	Speed Selection 2 (Reverse External Torque Limit Input)

a) Contact Input Speed Control when Cn-02 bit 2 = 1

0: OFF, 1: ON

Contact Signal			User Constant			Selected Speed	
P-CON	P-CL	N-CL	Cn-02	Cn-01			
			Bit 2	Bit A	Bit B		
—	0	0	1	0	0	Stop	Stopped by internal speed reference 0
				1	0		Stopped by zero-clamp
				0	1	Analog speed reference (V-REF) input	With zero-clamp function
				1	1		
Direction of rotation 0: Forward 1: Reverse	0	1	—	—	—	—	SPEED1 (Cn-1F)
	1	1					SPEED2 (Cn-20)
	1	0					SPEED3 (Cn-21)

Preset values (0 or 1) and input signal status in the portions indicated by horizontal bars (—) are optional.

b) Standard Setting when Cn-02 bit 2 = 0

Input signals are used as external torque limit input.

Input signal  $\overline{P-CON}$  is used to specify the direction of motor rotation.

→ Input  $\overline{P-CON}$  CN1-15 Proportional Control, etc.

a) Contact Input Speed Control when Cn-02 bit 2 = 1

Use input signal  $\overline{P-CON}$  to specify the direction of motor rotation.

P-CON	Meaning
1	Reverse rotation
0	Forward rotation

0: OFF (high level), 1: ON (low level)

b) Standard Setting when Cn-02 bit 2 = 0

$\overline{P-CON}$  signal is used for proportional control, zero-clamp and torque/speed control changeover.

**Note** For the speed/torque control type, control by external reference (voltage reference) is possible when the contact input speed control function is used by setting bits A and B of user constant Cn-01.

4) The figure below illustrates an example of operation in contact input speed control mode. Using the soft start function reduces physical shock at speed changeover.

When Contact Input Speed Control is Used

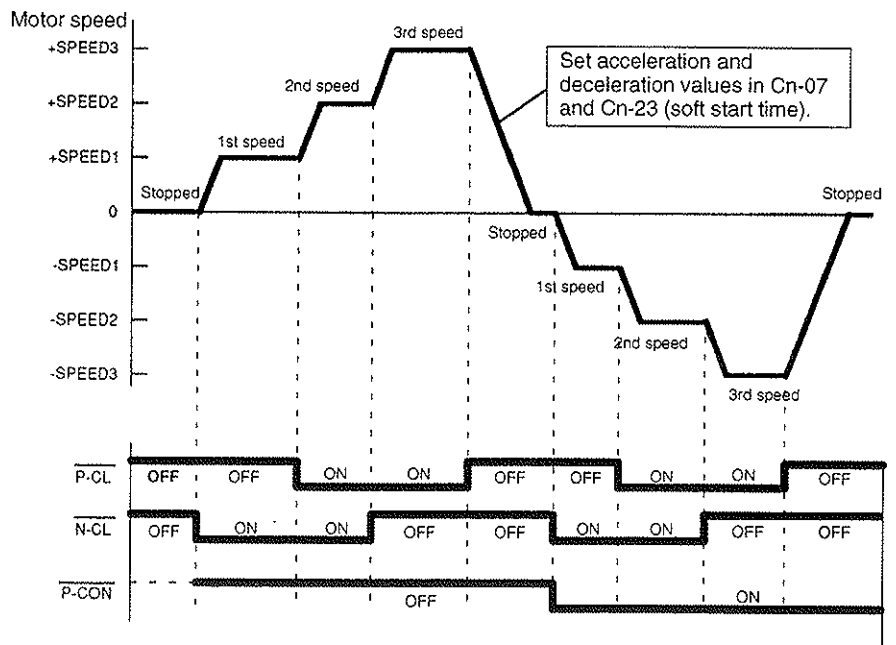

## 2.2.5 Using Torque Control

1) The Servopack can provide the following torque control:

- Torque restriction
  - Level 1: To restrict the maximum output torque to protect the machine or workpiece
  - Level 2: To restrict torque after the motor moves the machine to a specified position
- Torque control
  - Level 3: To always control output torque, not speed
  - Level 4: To switch between speed control and torque control

This section describes how to use levels 3 and 4 of the torque control function.

2) Use the following memory switch to select level 3 (torque control I) or level 4 (torque control II).

Cn-01 Bit A	Control Mode Selection	Factory Setting: 0
Cn-01 Bit B	Control Mode Selection	Factory Setting: 0

This is dedicated torque control.

A motor torque reference value is externally input into the Servopack to control torque.

### Examples of Use: Tension control Pressure control

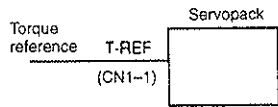
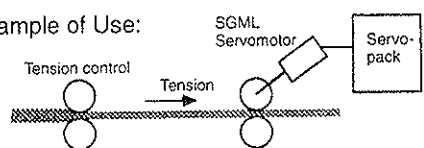
Cn-01 Setting		Control Mode
Bit B	Bit A	
1	0	<p><b>Torque Control I</b></p> <p>This is a dedicated torque control mode.</p> <div style="text-align: right;">  </div> <ul style="list-style-type: none"> <li>• A torque reference is input from T-REF (CN1-1).</li> <li>• P-CON is not used.</li> <li>• Speed reference input V-REF (CN1-3) cannot be used.</li> <li>• User constant Cn-14 can be used for maximum speed control.</li> </ul> <p>Example of Use:</p> <div style="text-align: center;">  </div>

Cn-01 Setting		Control Mode				
Bit B	Bit A					
1	1	<p><b>Torque Control II</b></p> <p>Torque control and speed control can be switched.</p> <ul style="list-style-type: none"> <li>• A speed reference or speed limit value is input from V-REF (CN1-3).</li> <li>• T-REF (CN1-1) inputs a torque reference, torque feed-forward reference or torque limit value depending on the control mode used.</li> <li>• P-CON (CN1-15) is used to switch between torque control and speed control.</li> </ul> <table border="1" style="margin-left: auto; margin-right: auto;"> <tr> <td>When CN1-15 is open</td> <td>Torque control</td> </tr> <tr> <td>When CN1-15 is at 0 V</td> <td>Speed control</td> </tr> </table> <div style="text-align: right; margin-top: 20px;"> <p>Speed reference V-REF (CN1-3) Torque reference T-REF (CN1-1) Switching between speed and torque reference P-CON (CN1-15)</p> </div>	When CN1-15 is open	Torque control	When CN1-15 is at 0 V	Speed control
When CN1-15 is open	Torque control					
When CN1-15 is at 0 V	Speed control					
1	1	<p>For Torque Control when P-CON is OFF:</p> <ul style="list-style-type: none"> <li>• T-REF reference controls torque.</li> <li>• V-REF can be used to limit motor speed.</li> <li>• V-REF voltage (+) limits motor speed during forward or reverse rotation.</li> </ul> <p><b>Principle of Speed Restriction:</b></p> <p>When the speed exceeds the speed limit, negative feedback of torque proportional to the difference between the current speed and the limit speed is performed to return the speed to within the normal speed range. Therefore, the actual motor speed limit value has a certain range depending on the load conditions.</p> <div style="text-align: right; margin-top: 20px;"> </div>				

Cn-01 Setting		Control Mode																							
Bit B	Bit A																								
1	1	For Speed Control when P-CON is ON: Values set in bit F of user constant Cn-01 and bit F of Cn-02 determine the following:																							
		<table border="1"> <thead> <tr> <th colspan="2">User Constant</th> <th rowspan="2">Speed Reference Input</th> <th rowspan="2">Torque Input</th> <th rowspan="2">Remarks</th> </tr> <tr> <th>Cn-01 Bit F</th> <th>Cn-02 Bit F</th> </tr> </thead> <tbody> <tr> <td>0</td> <td>0</td> <td>Speed control</td> <td>Cannot be used</td> <td></td> </tr> <tr> <td>1</td> <td>—</td> <td>Speed control with torque feed-forward</td> <td>Torque feed-forward</td> <td></td> </tr> <tr> <td>0</td> <td>1</td> <td>Speed control with torque limit by analog voltage reference</td> <td>Torque limit value</td> <td>For details of speed control with torque limit by analog voltage reference, refer to 2.2.6 Using Torque Restriction by Analog Voltage Reference.</td> </tr> </tbody> </table>		User Constant		Speed Reference Input	Torque Input	Remarks	Cn-01 Bit F	Cn-02 Bit F	0	0	Speed control	Cannot be used		1	—	Speed control with torque feed-forward	Torque feed-forward		0	1	Speed control with torque limit by analog voltage reference	Torque limit value	For details of speed control with torque limit by analog voltage reference, refer to 2.2.6 Using Torque Restriction by Analog Voltage Reference.
		User Constant		Speed Reference Input	Torque Input				Remarks																
		Cn-01 Bit F	Cn-02 Bit F																						
0	0	Speed control	Cannot be used																						
1	—	Speed control with torque feed-forward	Torque feed-forward																						
0	1	Speed control with torque limit by analog voltage reference	Torque limit value	For details of speed control with torque limit by analog voltage reference, refer to 2.2.6 Using Torque Restriction by Analog Voltage Reference.																					
0	0	Speed control	(Standard setting)																						
0	1	Zero-clamp speed control																							

3) The following input signals perform torque control.

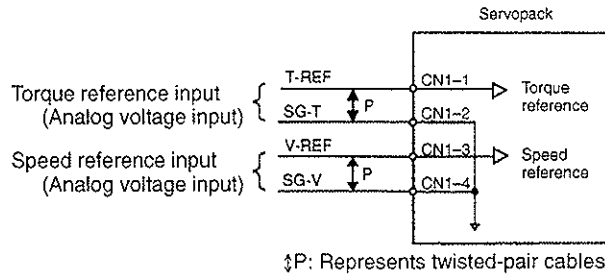

→ Input T-REF CN1-1	Torque Reference Input
→ Input SG-T CN1-2	Signal Ground for Torque Reference Input

These signals are used when torque control is selected (bits A and B of memory switch Cn-01).

Motor torque is controlled so that it is proportional to the input voltage between T-REF and SG-T.

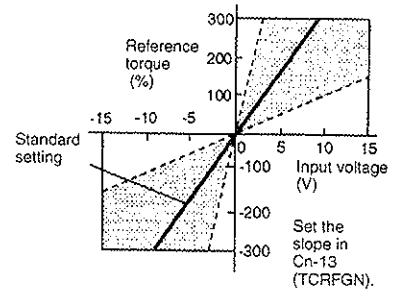

**Standard Setting**

Cn-13 = 30: This setting means that 3 V is equivalent to rated torque.

- Examples: +3 V input → Rated torque in forward direction
- +9 V input → 300% of rated torque in forward direction
- 0.3 V input → 10% of rated torque in reverse direction

User constant Cn-13 can be used to change the voltage input range.

Example of Input Circuit:  
See the figure on the right.

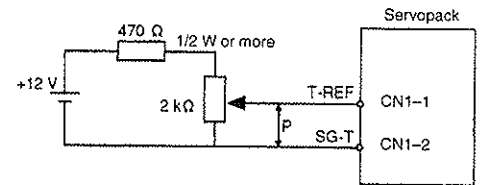

- For noise control, always use twisted-pair cables.

- Example of Variable Resistor for Speed Setting:  
Type 25HP-10B manufactured by Sakae Tsushin Kogyo Co., Ltd.

→ Input V-REF CN1-3	Speed Reference Input (or Speed Limit Input)
→ Input SG-V CN1-4	Signal Ground for Speed Reference Input

These signals are used when speed control is selected (bits A and B of memory switch Cn-01).

For normal speed control, always connect these signal terminals.

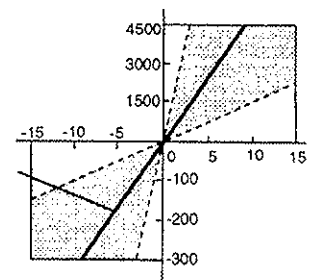

Motor speed is controlled so that it is proportional to the input voltage between V-REF and SG-V.

**Standard Setting**

Cn-03 = 500: This setting means that 6 V is equivalent to rated speed (3000 r/min).

- Examples: +6 V input → 3000 r/min in forward direction
- +1 V input → 500 r/min in forward direction
- 3 V input → 1500 r/min in reverse direction

User constant Cn-03 can be used to change the voltage input range. (This is also applicable to speed restriction.)

Example of Input Circuit:  
See the figure on the right.

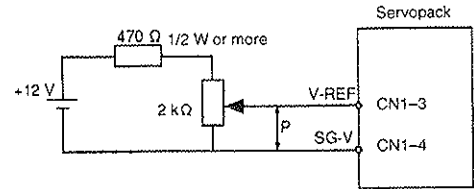

- For noise control, always use twisted-pair cables.
- Example of Variable Resistor for Speed Setting:  
Type 25HP-10B manufactured by Sakae Tsushin Kogyo Co., Ltd.

When input signal  $\overline{\text{P-CON}}$  is used to switch between speed reference and torque reference for torque control II, set both bits A and B of memory switch Cn-01 to 1.

→ **Input P-CON CN1-15** Proportional Control, etc.

The function of this input signal varies according to the memory switch setting.

Cn-02 Bit 2	Cn-01 Bit B	Cn-01 Bit A	Function of P-CON
0	0	0	Proportional control (Standard setting)
0	0	1	Zero-clamp control
0	1	0	Not used
0	1	1	<b>Torque/speed changeover control</b>
1	—	—	Rotation direction control for contact input speed control

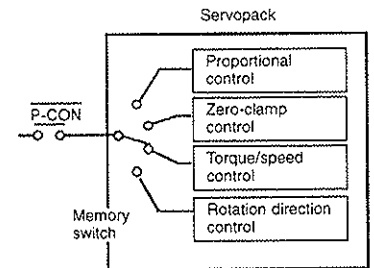

The function of P-CON signal varies according to the memory switch setting.

• **Torque/Speed Changeover Control**

This function is used to switch between torque control and speed control in torque control II mode.

ON: CN1-15 is at low level.	Speed control
OFF: CN1-15 is at high level.	Torque control

2.2.5 Using Torque Control cont.

4) Set the following user constants for torque control according to the servo system used.

<b>Cn-13</b>	TCRFGN Torque Reference Gain	Unit: 0.1 V/Rated Torque	Setting Range: 10 to 100	Factory Setting: 30
--------------	---------------------------------	--------------------------------	--------------------------------	---------------------------

Sets the voltage range of torque reference input T-REF (CN1-1) according to the output form of the host controller or external circuit.

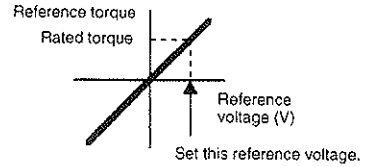

The factory setting is 30, so the rated torque is 3 V (30 x 0.1).

<b>Cn-14</b>	TCRLMT Speed Limit for Torque Control I	Unit: r/min	Setting Range: 0 to Maximum Speed	Factory Setting: Maximum Speed
--------------	--	-------------	---	---

Sets a motor speed limit value in this constant when torque control I is selected.

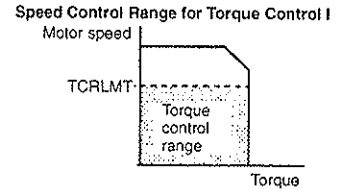

This user constant is used to prevent machine overspeed during torque control.

For torque control I, set bits A and B of memory switch Cn-01.

<b>Cn-03</b>	VREFGN Speed Reference Gain	Unit: (r/min)/V	Setting Range: 0 to 2162	Factory Setting: 500
--------------	--------------------------------	--------------------	-----------------------------	-------------------------

Sets the voltage range of speed reference input V-REF (CN1-3) according to the output form of the host controller or external circuit.

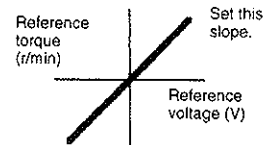

The factory setting is 500 [rated speed (3000 r/min)/6 V = 500].



## 2.2.6 Using Torque Restriction by Analog Voltage Reference

### 1) Outline

This function restricts torque by assigning the T-REF terminal (CN1-3, CN1-4) a torque limit value in terms of analog voltage. Since torque reference input terminal T-REF is used as an input terminal, this function cannot be used for torque control.

Schematic Block Diagram for Torque Restriction by Analog Voltage Reference

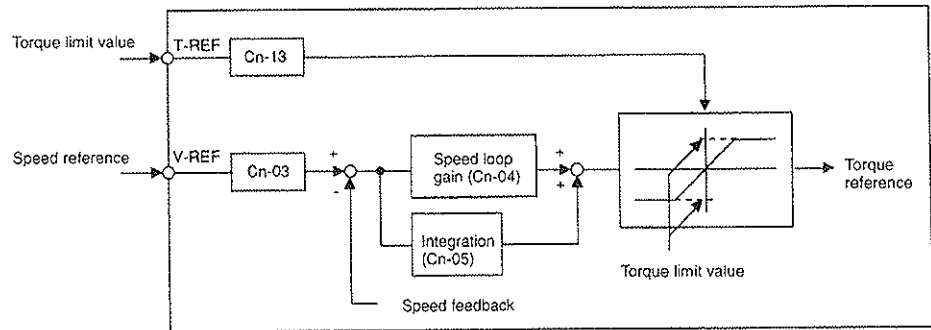

### 2) How to Use Torque Restriction by Analog Voltage Reference

To use this torque restriction function, set the following memory switch to 1.

Cn-02 Bit F	Torque Restriction by Analog Voltage Reference	Factory Setting: 0
-------------	--	--------------------

Enables this torque restriction function.

To use this function, input a speed reference to the V-REF terminal and a torque limit value to the T-REF terminal.

This function cannot be used for torque control.

Torque restriction cannot be set separately for forward and reverse rotation. (The same setting applies to both forward and reverse rotation.)

Setting	Meaning
0	Uses the T-REF terminal as a torque reference
1	Uses the T-REF terminal as a torque limit value input terminal.

### 3) Setting a Torque Limit Value in User Constant Cn-13

The factory setting is Cn-13 = 30. If, for example, the torque limit value is 3 V, torque is restricted to 100% (rated torque). A torque value in excess of 100% is clamped at 100%.

Cn-13	TCRFGN Torque Reference Gain	Unit: 0.1 V/ Rated Torque	Setting Range: 10 to 100	Factory Setting: 30
-------	---------------------------------	------------------------------	-----------------------------	------------------------

## 2.3 Setting Up the $\Sigma$ -L Servopack

▣ This section describes how to set user constants to operate the SGD L Servopack.

2.3.1	Using Autotuning Function .....	62
2.3.2	Setting Servo Gain .....	62
2.3.3	Setting the Torque Reference Filter Time Constant .....	63
2.3.4	Using the Soft Start Function .....	64
2.3.5	Using Proportional Control .....	64
2.3.6	Setting the Mode Switch Level .....	65

### 2.3.1 Using Autotuning Function

- 1) If speed loop gain and position loop gain for the servo system are not set properly, positioning may become slow. Techniques and experience are required to set these servo gain values according to machine configuration and machine rigidity.
- 2)  $\Sigma$ -series Servopacks have an autotuning function that automatically measures machine characteristics and sets the necessary servo gain values. With this function, even first-time servo users can easily perform tuning for servo gain. Servo gain values are set in user constants.
- 3) The following user constants can be automatically set by the autotuning function.

User Constant	Meaning
Cn-04	Speed loop gain
Cn-05	Speed loop integration time constant

- 4) For details of how to perform autotuning, refer to *3.2.3 Autotuning*

### 2.3.2 Setting Servo Gain

- 1) Check and reset the servo gain when:
  - a) Automatically set servo gain values need to be checked after autotuning.
  - b) Each servo gain value checked in a) is to be directly set for another Servopack.
  - c) Response performance needs to be further enhanced after autotuning, or servo gain values need to be reset for a system with lower response performance.

2) Set the following user constants related to speed loop as necessary.

<b>Cn-04</b>	LOOPHZ Speed Loop Gain (Kv)	Unit: Hz	Setting Range: 1 to 2000	Factory Setting: 80
<b>Cn-05</b>	PITIME Speed Loop Integration Time Constant (Ti)	Unit: ms	Setting Range: 2 to 10000	Factory Setting: 20

Cn-04 and Cn-05 are a speed loop gain and an integration time constant for the Servopack, respectively.

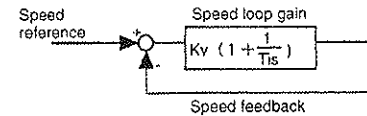

The higher the speed loop gain value or the smaller the speed loop integration time constant value, the higher the speed control response. There is, however, a certain limit depending on machine characteristics.

Factory setting of speed loop gain is PI control as shown above. P control and PI control can be switched by P-CON (CN1-15).

<b>P-CON is OFF</b>	PI Control
<b>P-CON is ON</b>	P Control

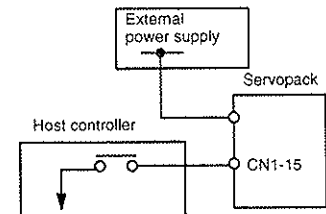

These user constants are automatically set by the autotuning function.

### 2.3.3 Setting the Torque Reference Filter Time Constant

1) If the machine causes vibration, possibly resulting from the servo drive, adjust the following filter time constant. Vibration may stop.

<b>Cn-17</b>	TRQFIL Torque Reference Filter Time Constant	Unit: 100 $\mu$ s	Setting Range: 0 to 250	Factory Setting: 4
--------------	---	-------------------	----------------------------	-----------------------

Cn-17 is a torque reference filter time constant for the SGLD Servopack. The smaller the value, the higher the torque control response. There is, however, a certain limit depending on machine conditions.

With the standard setting, the machine may cause vibration resulting from the servo drive. In this case, increase the constant setting. Vibration may stop. Vibration can be caused by incorrect gain adjustment, machine problems and so on.

### 2.3.4 Using the Soft Start Function

- 1) The soft start function adjusts progressive speed reference input inside the Servopack so that acceleration and deceleration can be as constant as possible. To use this function, set the following user constants.

<b>Cn-07</b>	SFSACC Soft Start Time (Acceleration)	Unit: ms	Setting Range: 0 to 10000	Factory Setting: 0
<b>Cn-23</b>	SFSDEC Soft Start Time (Deceleration)	Unit: ms	Setting Range: 0 to 10000	Factory Setting: 0

In the Servopack, a speed reference is multiplied by the acceleration or deceleration value set in Cn-07 or Cn-23 to provide speed control.

Smooth speed control can be achieved when progressive speed references are input or when contact input speed control is used.

Set these user constants as follows.

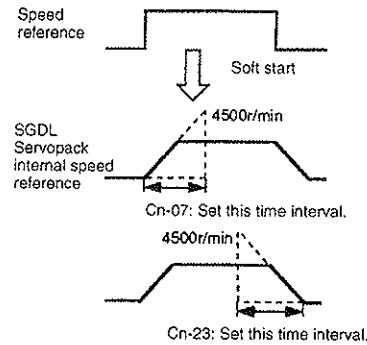

Cn-07: Time interval from the time the motor starts until the maximum speed (4500 r/min) is reached

Cn-23: Time interval from the time the motor is running at the maximum speed (4500 r/min) until it stops

### 2.3.5 Using Proportional Control

- 1) If both bits A and B of memory switch Cn-01 are set to 0 as shown below, input signal  $\overline{P-CON}$  serves as a PI/P control changeover switch.

- PI Control: Proportional/Integral control
- P Control: Proportional control

<b>Cn-01 Bit A</b>	Control Mode Selection	Factory Setting: 0
<b>Cn-01 Bit B</b>	Control Mode Selection	Factory Setting: 0

For speed/torque control (SGDL-□□□S) only.

Cn-01 Setting		Control Mode					
Bit B	Bit A						
0	0	<p><b>Speed Control</b> This is normal speed control.</p> <ul style="list-style-type: none"> <li>Speed reference is input from V-REF (CN1-3).</li> <li>Signal P-CON (CN1-15) is used to switch between P control and PI control.</li> </ul> <table border="1"> <tr> <td>P-CON (CN1-15) is open (OFF)</td> <td>PI control</td> </tr> <tr> <td>P-CON (CN1-15) is closed (ON)</td> <td>P control</td> </tr> </table> <ul style="list-style-type: none"> <li>Torque reference input T-REF (CN1-1) cannot be used.</li> </ul>	P-CON (CN1-15) is open (OFF)	PI control	P-CON (CN1-15) is closed (ON)	P control	<p>SGDL Servopack</p> <p>Speed referen: V-REF (CN1-3)</p> <p>P/PI change: P-CON (CN1-15)</p>
P-CON (CN1-15) is open (OFF)	PI control						
P-CON (CN1-15) is closed (ON)	P control						

2) Proportional control can be used in the following two ways.

- a) When operation is performed by sending speed references from the host controller to the Servopack, the host controller can selectively use P control mode for particular conditions only. This method can prevent the occurrence of overshoot and also shorten settling time.
- b) If PI control mode is used when the speed reference has a reference offset, the motor may rotate at a very slow speed and fail to stop even if 0 is specified as a speed reference. In this case, use P control mode to stop the motor.

### 2.3.6 Setting the Mode Switch Level

1) Use the mode switch to prevent overshoot during acceleration or deceleration.

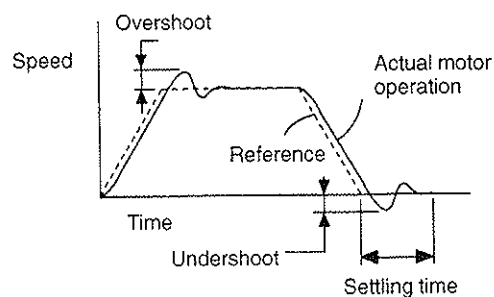

- 2) In other words, the mode switch is a function that automatically switches the speed control mode inside the Servopack **from PI control to P control** while certain conditions are being established.

**NOTE** The mode switch is used to fully utilize performance of a servo drive to achieve very high-speed positioning. The speed response waveform must be observed to adjust the mode switch.  
 For normal use, the speed loop gain set by autotuning provide sufficient speed/position control.  
 Even if overshoot or undershoot occurs, they can be suppressed by setting the acceleration/deceleration time constant for the host controller, the soft start time constants (Cn-07, Cn-23), or smoothing time constant (Cn-26) for the Servopack.

SGDL Servopack uses torque reference as a detection point of mode switch.

If a torque reference exceeds the torque value set in user constant Cn-0C, the speed loop switches to P control.

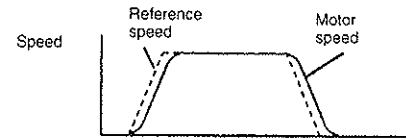

Factory setting of mode switch level is 200% torque (Cn-0C).

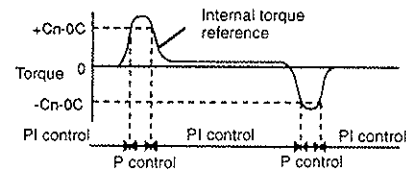

**Example of Operation:**

**If a mode switch is not used and PI control is always performed, torque may enter a saturation state during acceleration or deceleration, causing the motor speed to have overshoot or undershoot.**  
**Using the mode switch suppresses torque saturation and prevents the motor speed from having overshoot and undershoot.**

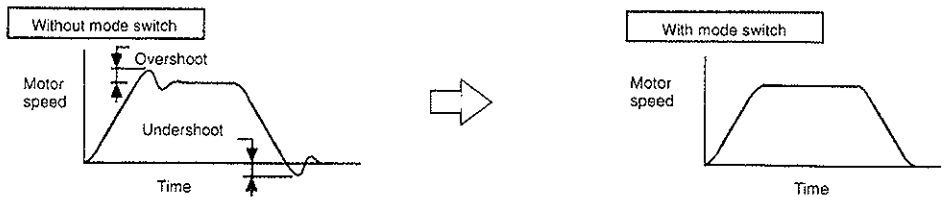

**From PI control to P control**

PI control means proportional/integral control and P control means proportional control. In short, switching “from PI control to P control” reduces effective servo gain, making the servo system more stable.

## 2.4 Setting Stop Mode

■ This section describes how to stop the motor properly.

2.4.1	Adjusting Offset .....	67
2.4.2	Dynamic Brake .....	68
2.4.3	Using Zero-Clamp .....	68
2.4.4	Using Holding Brake .....	70

### 2.4.1 Adjusting Offset

#### 1) "Why does not the motor stop?"

When 0 V is specified as reference voltage for Servopack for speed/torque control, the motor may rotate at a very slow speed and fail to stop. This happens when reference voltage from the host controller or external circuit has a slight reference offset (in mV units). If this offset is adjusted to 0 V, the motor will stop.

When reference voltage from the host controller or external circuit has an offset

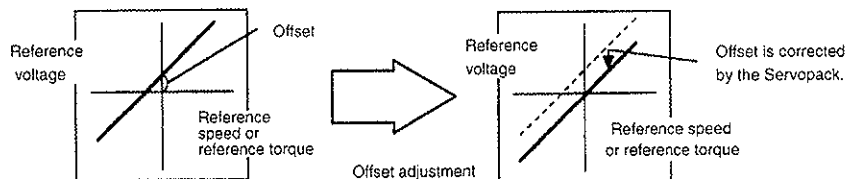

#### 2) The following two methods can be used to adjust the reference offset to 0 V.

1) Automatic adjustment of reference offset	Reference offset is automatically adjusted to 0 V.
2) Manual adjustment of reference offset	Reference offset can be intentionally set to a specified value.

**NOTE** If a position control loop is formed in the host controller, do not use automatic adjustment in 1. Always use manual adjustment in 2.

3) For detailed adjustment procedures, refer to the following sections.

	Adjustment Method
1) Automatic adjustment of reference offset	3.2.7 Reference Offset Automatic Adjustment
2) Manual adjustment of reference offset	3.2.8 Speed Reference Offset Manual Adjustment Mode

### 2.4.2 Dynamic Brake

1) The Servopack enters servo OFF status when:

- Servo ON input signal (S-ON, CN1-14) is turned OFF
- Servo alarm occurs
- Power is turned OFF

Then, stops the servomotor by **dynamic brake (DB)**.

### 2.4.3 Using Zero-Clamp

1) The zero-clamp function is used for a system in which the host controller does not form a position loop by speed reference input.

In other words, this function is used to cause the motor to stop and enter a servo locked status when the input voltage of speed reference V-REF is not 0 V. When the zero-clamp function is turned ON, an internal position loop is temporarily formed, causing the motor to be clamped within one pulse. Even if the motor is forcibly rotated by external force, it returns to the zero-clamp position.

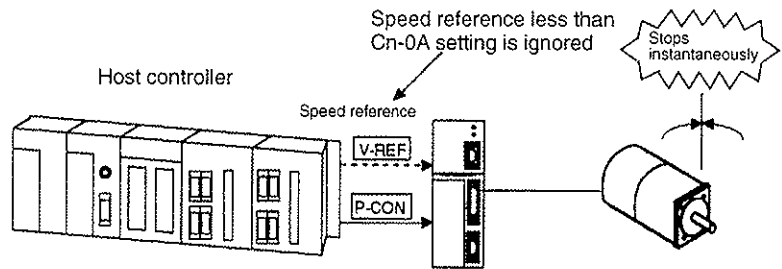

#### Dynamic brake (DB)

One of the general methods to cause a motor sudden stop. "Dynamic brake" suddenly stops a servomotor by shorting its electrical circuit. This dynamic brake circuit is incorporated in the Servopack.

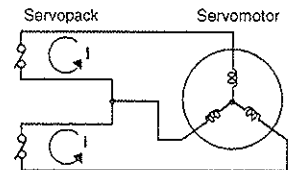



- 2) Set the following memory switch so that input signal  $\overline{P-CON}$  can be used to enable or disable the zero-clamp function.

Cn-01Bit A	Control Mode Selection	Factory Setting:0
Cn-01Bit B	Control Mode Selection	Factory Setting:0

→ Input **P-CON CN1-15** Proportional Control, etc.

Cn-01 Setting		Control Mode					
Bit B	Bit A						
0	1	<p><b>Zero-clamp Speed Control</b> This speed control allows the zero-clamp function to be set when the motor stops.</p> <ul style="list-style-type: none"> <li>A speed reference is input from V-REF (CN1-3).</li> <li><math>\overline{P-CON}</math> (CN1-15) is used to turn the zero-clamp function ON or OFF.</li> </ul> <table border="1"> <tr> <td><math>\overline{P-CON}</math> (CN1-15) is open (OFF)</td> <td>Turns zero-clamp function OFF</td> </tr> <tr> <td><math>\overline{P-CON}</math> (CN1-15) is closed (ON)</td> <td>Turns zero-clamp function ON</td> </tr> </table> <ul style="list-style-type: none"> <li>Torque reference input T-REF (CN1-1) cannot be used.</li> </ul>	$\overline{P-CON}$ (CN1-15) is open (OFF)	Turns zero-clamp function OFF	$\overline{P-CON}$ (CN1-15) is closed (ON)	Turns zero-clamp function ON	<p>Servopack</p> <p>Speed reference V-REF (CN1-3)</p> <p>Zero-clamp <math>\overline{P-CON}</math> (CN1-3)</p> <p><b>Zero-clamp is performed when the following two conditions are met:</b>  <math>\overline{P-CON}</math> signal is closed.          Motor speed is below the value set in Cn-0F (ZCLVL).</p>
$\overline{P-CON}$ (CN1-15) is open (OFF)	Turns zero-clamp function OFF						
$\overline{P-CON}$ (CN1-15) is closed (ON)	Turns zero-clamp function ON						

- 3) Set in the following user constant the motor speed level at which zero-clamp is to be performed:

Cn-0F	ZCLVL Zero-Clamp Level	Unit: r/min	Setting Range: 0 to Maximum Speed	Factory Setting: 10
-------	---------------------------	-------------	---	------------------------

If zero-clamp speed control is selected, set the motor speed level at which zero-clamp is to be performed.

**Conditions for Zero-clamp**

Zero-clamp is performed when all the following conditions are met:

- a) Zero-clamp speed control is selected. (Bits A and B of memory switch Cn-01 are set to 1 and 0, respectively.)
- b)  $\overline{\text{P-CON}}$  (CN1-15) is turned ON (0 V).
- c) Motor speed drops below the preset value.

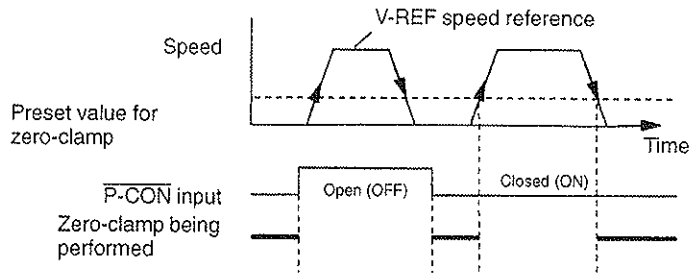

**2.4.4 Using Holding Brake**

1) Outline

Holding brake is useful when a servo drive is used to control a vertical axis. A servomotor with brake prevents the movable part from dropping due to gravitation when the system power is turned OFF.

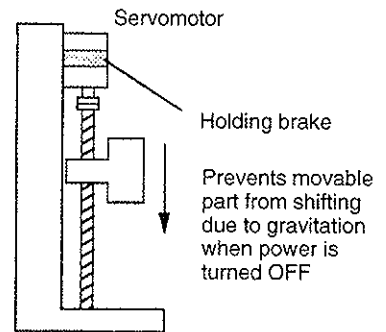

**NOTE** The built-in brake in Servomotor with brake is a de-energization operation type, which is used for holding purposes only and cannot be used for braking purposes. Use the holding brake only to retain a stopped motor. Brake torque is more than 100% of the rated motor torque.

- 2) Use Servopack contact output-signal  $\overline{\text{BK}}$  and brake power supply to form a brake ON/OFF circuit.

An example of standard wiring is shown below.

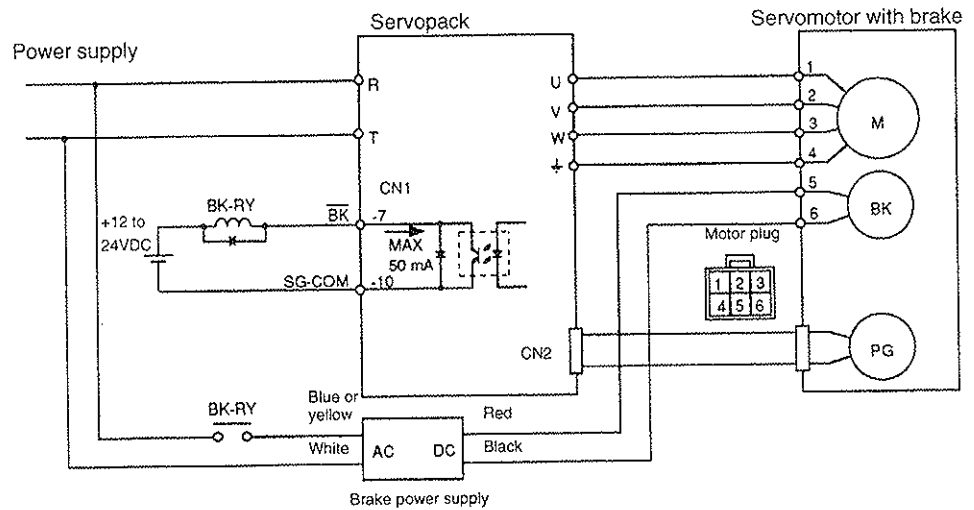

BK-RY: Brake control relay

Brake power supply has two types (200 V, 100 V).

**Output →  $\overline{\text{BK}}$  CN1-7**

Brake Interlock Output

This output signal controls the brake when a motor with brake is used. This signal terminal need not be connected when a motor without brake is used.

**Related User Constants**

Cn-12	Time delay from brake signal until servo OFF
Cn-15	Speed level for brake signal output during operation
Cn-16	Output timing of brake signal during motor operation

<p><b>ON Status:</b> Circuit between CN1-7 and CN1-10 is closed. CN1-7 is at low level.</p>	Releases the brake.
<p><b>OFF Status:</b> Circuit between CN1-7 and CN1-10 is open. CN1-7 is at high level.</p>	Applies the brake.

## 2.5 Forming a Protective Sequence

This section describes how to use I/O signals from the Servopack to form a protective sequence for safety purposes.

2.5.1	Using Servo Alarm Output and Alarm Code Output .....	72
2.5.2	Using Servo ON Input Signal .....	75
2.5.3	Using Running Output Signal .....	76
2.5.4	Handling of Power Failure .....	78

### 2.5.1 Using Servo Alarm Output and Alarm Code Output

#### 1) Basic Wiring for Alarm Output Signals

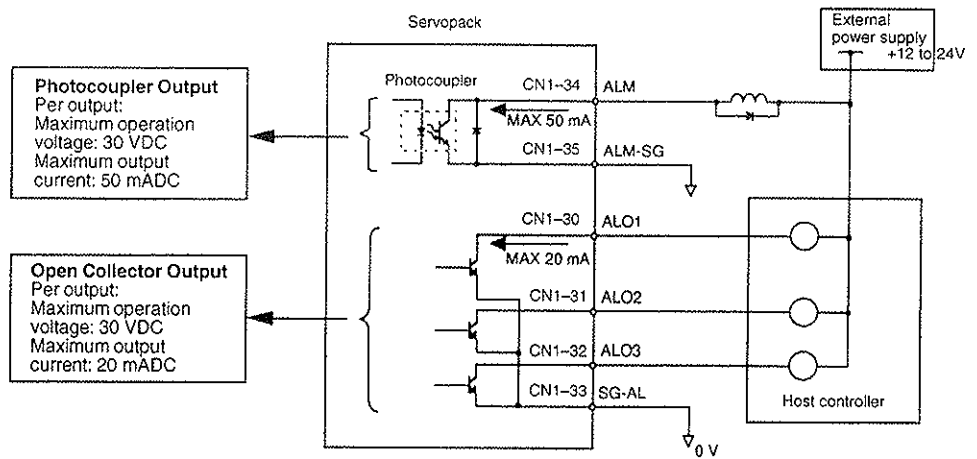

Provide an external power supply separately. There are no DC power available from Servopack for output signals.

#### 2) Contact Output Signal ALM

<b>Output → ALM CN1-34</b>	Servo Alarm Output
<b>Output → ALM-SG CN1-35</b>	Signal Ground for Servo Alarm Output

Signal ALM is output when the Servopack detects an alarm.

Form an external circuit so that this alarm output (ALM) turns the Servopack OFF.

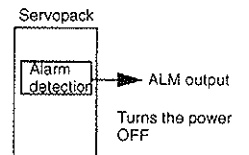

ON status:	Circuit between CN1-34 and CN1-35 is closed. CN1-34 is at low level.	Normal state
OFF status:	Circuit between CN1-34 and CN1-35 is open. CN1-34 is at high level.	Alarm state

Alarm codes ALO1, ALO2, and ALO3 are output to indicate each alarm type.

### 3) Contact Output Signals ALO1, ALO2, and ALO3

<b>Output → ALO1 CN1-30</b>	Alarm Code Output
<b>Output → ALO2 CN1-31</b>	Alarm Code Output
<b>Output → ALO3 CN1-32</b>	Alarm Code Output
<b>Output → SG-AL CN1-33</b>	Signal Ground for Alarm Code Output

These signals output an alarm code to indicate the type of an alarm detected by the Servopack.

Use these signals to display alarm codes at the host controller.

**NOTE** Using Alarm Codes:  
 When an alarm is detected, alarm output (ALM) causes the external circuit to turn the SGDL Servopack OFF. The alarm code remains output for at least 100 ms. For this reason, the host controller must read the alarm code within 100 ms of the alarm occurrence. When an alarm signal is output, be sure to identify the cause of the problem, take corrective action and operate again. For trouble shooting problems and procedures, refer to 5.2 Troubleshooting.

## APPLICATIONS OF $\Sigma$ -L SERIES PRODUCTS

### 2.5.1 Using Servo Alarm Output and Alarm Code Output cont.

#### 4) Relationship between Alarm Display and Alarm Code Output

Alarm Display and Alarm Code Output:

Alarm Display	Alarm Code Output			Servo Alarm (ALM) Output	Alarm Type	Alarm Description
	ALO1	ALO2	ALO3			
R10	○	×	×	×	Overcurrent	Overcurrent flowed through the main circuit. Servopack overheated.
R40	×	×	○	×	Overvoltage	Main circuit DC voltage has exceeded approximately 420 V.
R51	○	×	○	×	Overspeed	Motor speed has exceeded the maximum allowable speed.
R70	○	○	○	×	Overload	Motor and Servopack are overloaded.
RC <sup>*</sup>	○	×	○	×	Overrun Disconnection of PG signal line	Overrun occurred due to motor or encoder signal wiring faults. Encoder signal line is disconnected.
RF3	×	○	×	×	Power loss alarm	After power was turned OFF, power was turned ON again within power holding time. Power loss occurred during operation.
CPFD0	Undefined				Digital Operator transmission error	Communication error occurred between Digital Operator and Servopack.
CPFD1						
R99	×	×	×	○	No error	

○ : Output transistor is ON

× : Output transistor is OFF

\* : Displays an alarm category number.

- When the servo alarm (ALM) is output, eliminate the cause of the alarm and set the following ALMRST input signal at high level (+12 to 24 V) to reset the alarm state.

→ **Input ALMRST CN1-18** Alarm Reset

This signal is used to reset the servo alarm state.

**Normally, this signal terminal need not be wired.** This is because an external circuit is normally formed so that servo power is turned OFF when servo alarm is output. Alarm state is automatically reset when servo power is turned ON next time.

Alarm state can be reset using the Digital Operator.

When an alarm occurs, always eliminate the cause before resetting the alarm state. 5.2.1 *Troubleshooting Problems with Alarm Display* describes how to troubleshoot the system when an alarm arises.

### 2.5.2 Using Servo ON Input Signal

- This section describes how to wire and use contact input signal "servo ON (S-ON)." Use this signal to forcibly turn the servomotor OFF from the host controller.

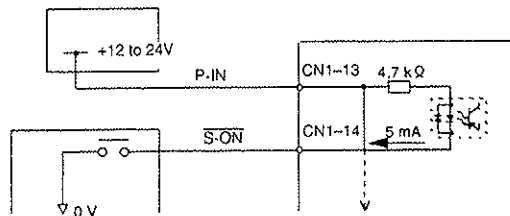

→ **Input S-ON CN1-14** Servo ON

This signal is used to turn the motor ON or OFF.

<b>ON: CN1-14 is at low level</b>	Turns the motor ON. This is normal operation state (called "servo ON state").
<b>OFF: CN1-14 is at high level</b>	Turns the motor OFF. This is inoperable state (called "servo OFF state"). If the servo is turned OFF during motor operation, the motor is decelerated to a stop by applying dynamic brake (standard setting). This function can be selected by setting bits 6 and 7 of memory switch Cn-01.

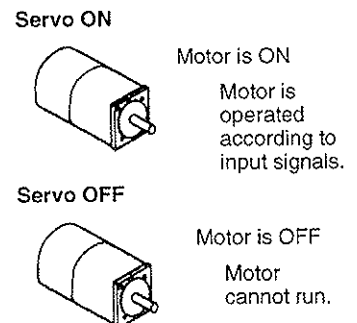

## APPLICATIONS OF Σ-L SERIES PRODUCTS

### 2.5.3 Using Running Output Signal

**NOTE** Do not use the  $\overline{S-ON}$  signal to start or stop the motor. Always use an input reference to start and stop the motor.

2) If the  $\overline{S-ON}$  signal is not to be used, set the following memory switch to 1:

Cn-01 Bit 0	Use of Servo ON Input Signal	Factory Setting: 0
-------------	------------------------------	--------------------

This memory switch is used to enable or disable the servo ON input signal  $\overline{S-ON}$  (CN1-14).

When external short-circuit wiring is omitted, set the memory switch to "1."

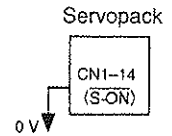

When S-ON is not used, this short-circuit wiring can be omitted.

Setting	Meaning
0	Uses servo ON signal $\overline{S-ON}$ . (When CN1-14 is open, servo is OFF. When CN1-14 is at 0 V, servo is ON.)
1	Does not use servo ON signal $\overline{S-ON}$ .

### 2.5.3 Using Running Output Signal

1) This section describes how to wire and use contact output signal  $\overline{TGON}$  as a running output signal. This signal indicates that a servomotor is currently running.

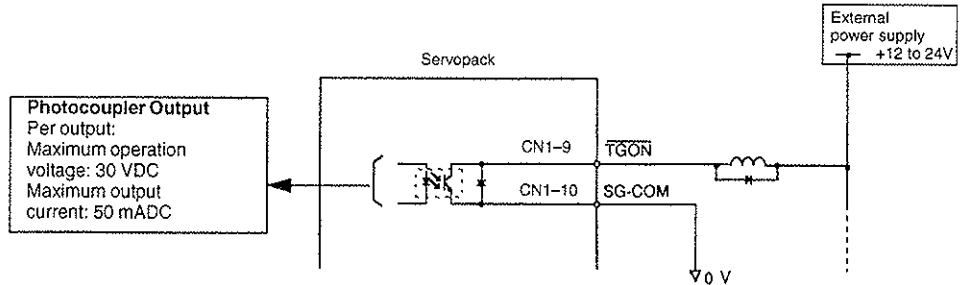

<b>Output</b> → $\overline{TGON}$ CN1-9	Running Output (Torque Limit Output)
---	--------------------------------------

This output signal indicates that the motor is currently running.

It is used as an external interlock.

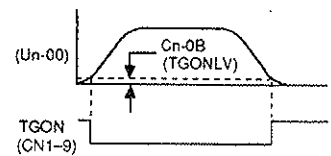



ON status:	Circuit between CN1-9 and CN1-10 is closed. CN1-9 is at low level.	Motor is running. (Motor speed is greater than the preset value.)
OFF status:	Circuit between CN1-9 and CN1-10 is open. CN1-9 is at high level.	Motor is stopped. (Motor speed is below the preset value.)

Preset value: Cn-0B (zero-speed level)

**Note** This function is changed to another function depending on the setting of bit 4 of memory switch Cn-01.

2) To use  $\overline{\text{TGON}}$  as a running output signal, set the following memory switch to "0."

Cn-01 Bit 4	$\overline{\text{TGON}}$ Output Signal Selection	Factory Setting: 0
-------------	--	--------------------

This memory switch is used to set output conditions for output signal  $\overline{\text{TGON}}$  (CN1-9)

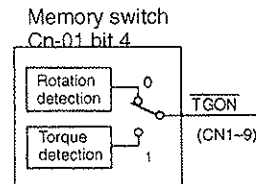

When  $\overline{\text{TGON}}$  signal is changed, the following bit data are also changed:

- Status indication mode bit data
- Monitor mode Un-05 bit 4

Setting	Meaning				
0	<p>Uses <math>\overline{\text{TGON}}</math> as a running output signal.  <math>\overline{\text{TGON}}</math> compares motor speed with the value set in Cn-0B (TGONLV).</p> <table border="1"> <tr> <td>Motor speed <math>\geq</math> preset value</td> <td>Closes circuit between CN1-9 and 1CN-10.</td> </tr> <tr> <td>Motor speed <math>&lt;</math> preset value</td> <td>Opens circuit between CN1-9 and 1CN-10.</td> </tr> </table>	Motor speed $\geq$ preset value	Closes circuit between CN1-9 and 1CN-10.	Motor speed $<$ preset value	Opens circuit between CN1-9 and 1CN-10.
Motor speed $\geq$ preset value	Closes circuit between CN1-9 and 1CN-10.				
Motor speed $<$ preset value	Opens circuit between CN1-9 and 1CN-10.				
1	<p>Uses <math>\overline{\text{TGON}}</math> as a torque limit output signal.  <math>\overline{\text{TGON}}</math> compares an internal torque (current) reference inside the SGDL Servopack with the preset value.  Preset Value: Cn-08 (TLMTF)  Cn-09 (TLMTR)  Cn-18 (CLMIF): <math>\overline{\text{P-CL}}</math> input only  Cn-19 (CLMIR): <math>\overline{\text{N-CL}}</math> input only</p> <table border="1"> <tr> <td>Internal torque (current) reference <math>\geq</math> preset value</td> <td>Closes the circuit between CN1-9 and CN1-10</td> </tr> <tr> <td>Internal torque (current) reference <math>&lt;</math> preset value</td> <td>Opens the circuit between CN1-9 and CN1-10</td> </tr> </table>	Internal torque (current) reference $\geq$ preset value	Closes the circuit between CN1-9 and CN1-10	Internal torque (current) reference $<$ preset value	Opens the circuit between CN1-9 and CN1-10
Internal torque (current) reference $\geq$ preset value	Closes the circuit between CN1-9 and CN1-10				
Internal torque (current) reference $<$ preset value	Opens the circuit between CN1-9 and CN1-10				

- 3) Use the following user constant to specify the output conditions for running output signal TGON.

Cn-0B	TGONLV	Zero-Speed Level	Unit: r/min	Setting Range: 1 to Maximum Speed	Factory Setting: 20
-------	--------	------------------	-------------	-----------------------------------	---------------------

This user constant is used to set the speed level at which the Servopack determines that the motor is running and then outputs a signal.

The following signals are output when motor speed exceeds the preset value. (The circuit between CN1-9 and CN1-10 is closed when motor speed exceeds the preset value.)

Signals are output when motor speed exceeds the preset value.

<ul style="list-style-type: none"> <li>• TGON (CN1-9)</li> <li>• Status indication mode bit data</li> <li>• Monitor mode Un-05 bit 4</li> </ul>
User Constant Setting: Memory switch Cn-01 bit 4 = 0

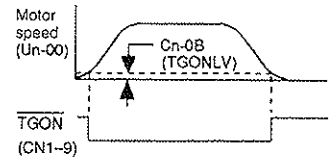

## 2.5.4 Handling of Power Failure

- 1) If the Servopack detects instantaneous voltage drop in power supply, it outputs alarm A.F3 to prevent a hazardous situation.

ALM output is OFF (circuit between CN1-34 and CN1-35 is open)

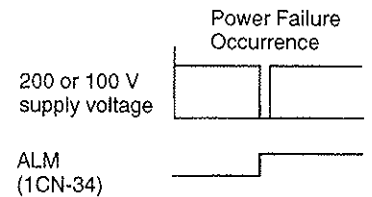

**Note** Clearing Servo Alarm:

To change a user constant that is made valid by turning the Servopack OFF and then ON, always wait for at least the “power holding time” after the Servopack is turned OFF, then turn the Servopack ON. Follow the procedure below.

- Make sure that all indicators (LEDs) on the Digital Operator have gone OFF.
- Make sure that the power and alarm indicators (LEDs) on the front panel of the Servopack have gone OFF.

Then, turn the power ON again.

**Reason**

When clearing servo alarm, the Servopack will operate normally even if it is turned ON without waiting "power holding time" after being turned OFF. In this case, however, the inside of the Servopack has not yet been reset (power ON reset). Therefore, user constants that have been modified do not become valid if these constants are made valid by turning the power OFF and then ON. Although the modified (new) settings appear on the display, the old settings are still valid inside the Servopack.

## 2.6 Special Wiring

This section describes special wiring methods including the one for noise control. Always refer to 2.6.1 *Notes on Wiring* and 2.6.2 *Wiring for Noise Control*, and refer to other sections as necessary.

2.6.1	Wiring Instructions .....	80
2.6.2	Wiring for Noise Control .....	82
2.6.3	Using More Than One Servo Drive .....	87
2.6.4	Using Regenerative Units .....	88
2.6.5	Using SGDL Servopack with High Voltage Line .....	91
2.6.6	Connector Terminal Layouts .....	93

### 2.6.1 Wiring Instructions

To ensure safe and stable operation, always refer to the following wiring instructions.

**NOTE** Always use the following cables for reference input and encoder wiring.

	Cable Type	Yaskawa Drawing No.	Maximum Allowable Length
For reference input	Twisted-pair cables	DE9404859	3 m (9.8 ft.)
For encoder	Multiconductor shielded twisted-pair cable	B9400064 (for incremental encoder)	20 m (65.6 ft.)

- Trim off the excess portion of the cable to minimize the cable length.

**NOTE** For a ground wire, use as thick a cable as possible.

- At least class 3 grounding (ground to 100 Ω or less) is recommended.
- Always use one-line grounding.
- If the motor is insulated from the machine, ground the motor directly.

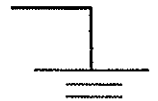

**NOTE** Do not bend or apply tension to cables.

- Since the conductor of a signal cable is very thin (0.2 to 0.3 mm), handle it with adequate care.

**NOTE** Use a noise filter to prevent noise interference.  
(For details, refer to the following *Caution*.)

- If the servo is to be used near private houses or may receive noise interference, install a noise filter on the input side of the power supply line. Since this Servopack is designed as an industrial device, it provides no mechanism to prevent noise interference.

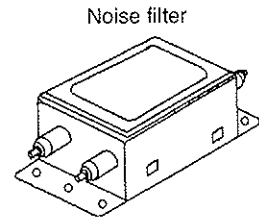

**NOTE** To prevent malfunction due to noise, take the following actions:

- Position the input reference device and noise filter as close to the Servopack as possible.
- Always install a surge absorber circuit in the relay, solenoid and magnetic contactor coils.
- The distance between a power line (such as a power supply line or motor cable) and a signal line must be at least 30 cm (12 in). Do not put the power and signal lines in the same duct or bundle them together.
- Do not share the power supply with an electric welder or electrical discharge machine. When the Servopack is placed near a high-frequency oscillator, install a noise filter on the input side of the power supply line.

- Note** a) Since Servopack uses high-speed switching elements, signal lines may receive noise. To prevent this, always take the above actions.  
b) For details of grounding and noise filters, refer to 2.6.2 *Wiring for Noise Control*.

**NOTE** Use a molded-case circuit breaker (MCCB) or fuse to protect the power supply line from high voltage.

- This Servopack is directly connected to commercial power supply without a transformer. Always use an MCCB or fuse to protect the servo system from accidental high voltage.
- Select an appropriate MCCB or fuse according to the Servopack capacity and the number of Servopacks to be used as shown below.

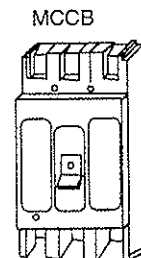

**MCCB or Fuse for Each Power Capacity**

Power Voltage	Servopack Type	Power Capacity Per Servopack (kVA) (see note 1)	Power Capacity Per MCCB or Fuse (A) (see note 2)
200 V	SGDL-A3AS	0.25	5
	SGDL-A5AS	0.3	
	SGDL-01AS	0.5	
	SGDL-02AS	0.75	
	SGDL-04AS	1.2	9
	SGDL-08AS	2.2	16
100 V	SGDL-A3BS	0.2	5
	SGDL-A5BS	0.3	
	SGDL-01BS	0.5	
	SGDL-02BS	0.75	8
	SGDL-03BS	1.4	15

- Note**
- 1) Power capacity at rated load
  - 2) Operating characteristics (25°C): 2 seconds or more for 200%, 0.01 second or more for 700%
  - 3) A fast-operating fuse cannot be used because the Servopack power supply is a capacitor input type. A fast-operating fuse may blow out when the power is turned ON.

**2.6.2 Wiring for Noise Control**

**1) Example of Wiring for Noise Control**

- a) This Servopack uses high-speed switching elements in the main circuit. It may receive "switching noise" from these high-speed switching elements if wiring or grounding around the Servopack is not appropriate. To prevent this, always wire and ground the Servopack correctly.
- b) This Servopack has a built-in microprocessor (CPU). To protect the microprocessor from external noise, install a noise filter in place.

c) The following is an example of wiring for noise control.

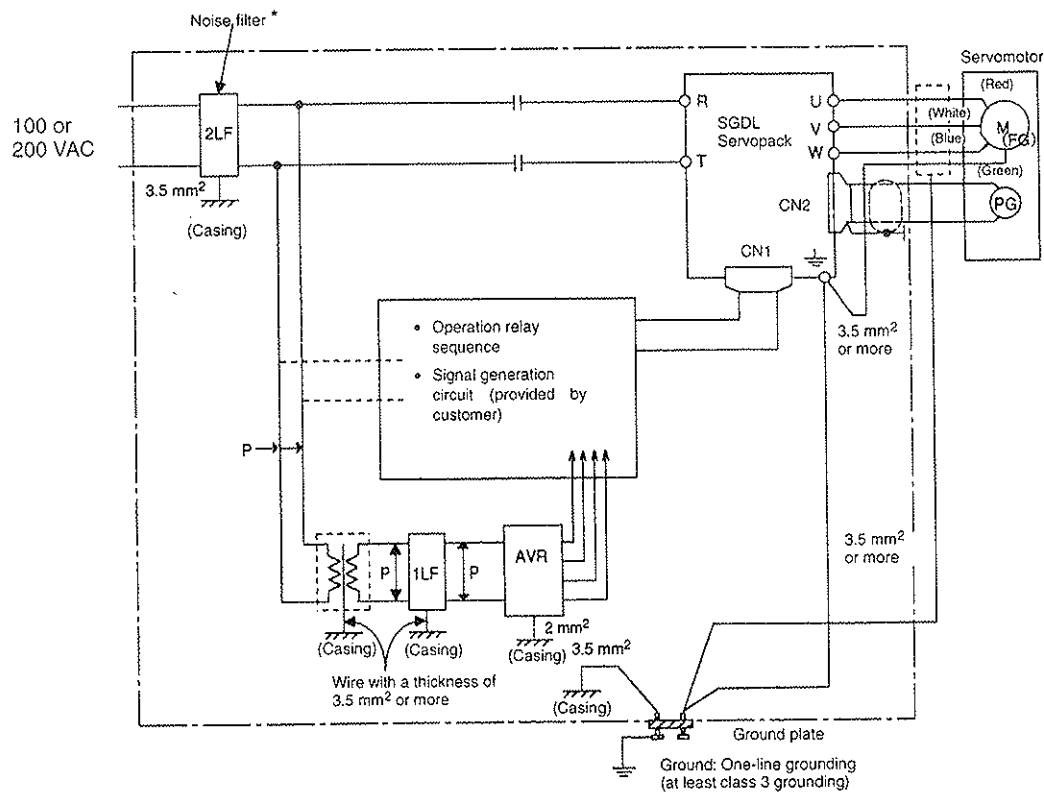

\* When using a noise filter, always observe the following wiring instructions:

- Note**
- For a ground wire to be connected to the casing, use a thick wire with a thickness of at least 3.5 mm<sup>2</sup> (preferably, plain stitch cooper wire).
  - For wires indicated by P↓, use twisted-pair cables whenever possible.

## 2) Correct Grounding

- Always ground the motor frame.

Always connect servomotor frame terminal FG (green) to the Servopack ground terminal. Be sure to ground the ground terminal.

- If the servomotor is grounded via the machine, a switching noise current will flow from the Servopack power unit through motor stray capacitance. The above grounding is required to prevent the adverse effects of switching noise.
- If the reference input line receives noise, do the following.

Ground the 0 V line (such as SG-V and SG-T) of the reference input line. If the main circuit wiring for the motor is accommodated in a metal conduit, ground the conduit and its junction box. For all grounding, always use one-line grounding.

3) Noise Filter Installation

- a) Use an inhibit type noise filter to prevent noise from the power supply line.

Install a noise filter on the power supply line for peripheral equipment as necessary.

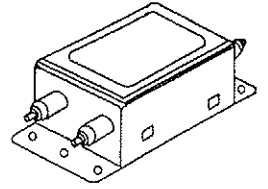

The following table lists recommended noise filters for each Servopack type.

Noise Filter Types

Power Voltage	Servopack Type		Noise Filter Connection	Recommended Noise Filter	
				Type	Specifications
200 V	30 W (0.04 HP)	SGDL-A3AS		LF-205A	Single-phase 200 VAC, 5 A
	50 W (0.07 HP)	SGDL-A5AS			
	100 W (0.13 HP)	SGDL-01AS			
	200 W (0.27 HP)	SGDL-02AS		LF-210	Single-phase 200 VAC, 10 A
	400 W (0.53 HP)	SGDL-04AS			
	750 W (1.01 HP)	SGDL-08AS			
100 V	30 W (0.04 HP)	SGDL-A3BS		LF-205A	Single-phase 200 VAC, 5 A
	50 W (0.07 HP)	SGDL-A5BS			
	100 W (0.13 HP)	SGDL-01BS		LF-210	Single-phase 200 VAC, 10 A
	200 W (0.27 HP)	SGDL-02BS			
	300 W (0.39 HP)	SGDL-03BS			

**Note** These noise filters are manufactured by Tokin Corp. and available from Yaskawa. For noise filters, contact your nearest Yaskawa sales representatives.



b) Always observe the following installation and wiring instructions. Incorrect use of a noise filter halves its benefits.

- Separate input lines from output lines.

Do not put the input and output lines in the same duct or bundle them together.

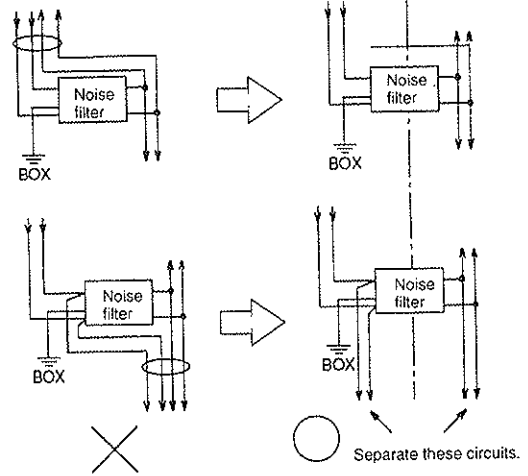
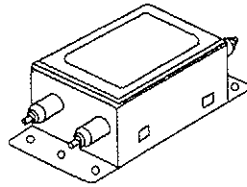

- Separate the noise filter ground wire from the output lines.

Do not accommodate the noise filter ground wire, output lines and other signal lines in the same duct or bundle them together.

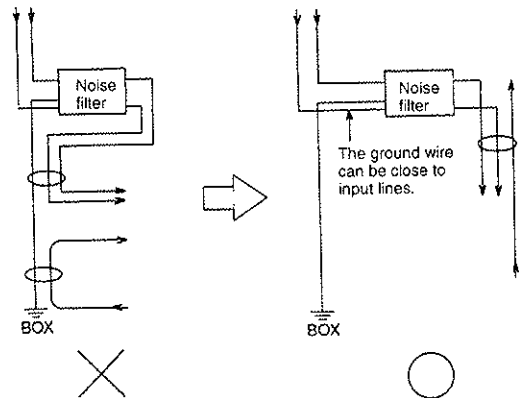

## APPLICATIONS OF $\Sigma$ -L SERIES PRODUCTS

### 2.6.2 Wiring for Noise Control cont.

- Connect the noise filter ground wire directly to the ground plate.

Do not connect the noise filter ground wire to other ground wires.

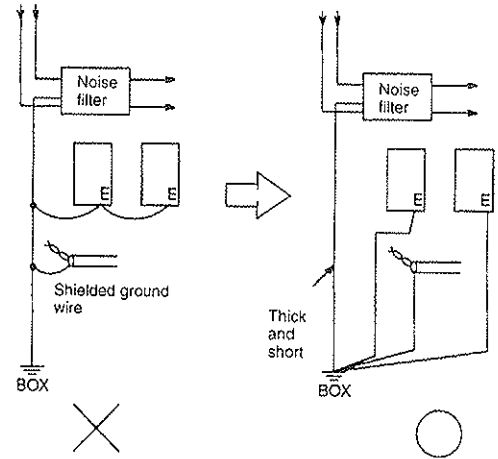

- When grounding a noise filter inside a Unit.

If a noise filter is located inside a Unit, connect the noise filter ground wire and the ground wires from other devices inside the Unit to the ground plate for the Unit first, then ground these wires.

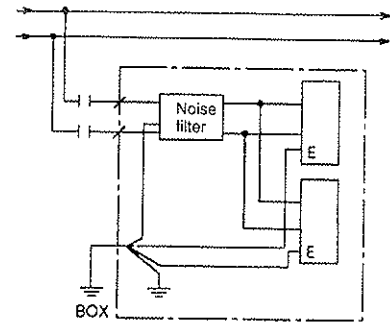



- 2) When some of the Servopack's regenerative capacity is not sufficient, connect terminals P and N for regenerative units in parallel. Since the Servopack power supply is a capacitor input type, connecting P and N terminals in parallel produces high power capacity over all, enhancing regenerative performance.
- 3) When connecting P and N terminals in parallel, be sure to turn all the Servopack power ON simultaneously. Do not turn any Servopack power ON when connection P and N terminals in parallel.
- 4) Multiple servos can share a single MCCB or noise filter. Always select a MCCB or noise filter that has enough capacity for the total power capacity (load conditions) of those servos. For details, refer to page 82.

MCCB

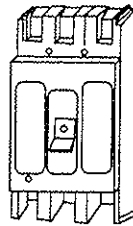

Noise filter

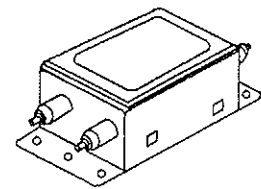

## 2.6.4 Using Regenerative Units

### 1) "What is a Regenerative Unit?"

A regenerative unit is designed to safely consume electric energy that is generated when the servomotor is rotated by the load.

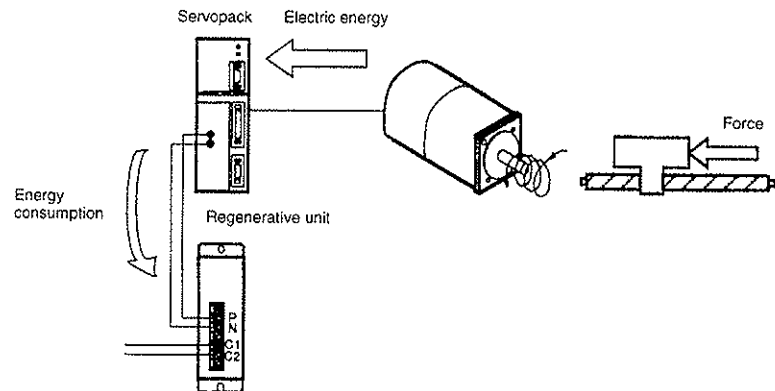

## 2) "When is a Regenerative Unit Required?"

For general use, a regenerative unit is not required. In the following cases, however, the user must determine whether a regenerative unit is required or not:

- a) When the motor is used to control a vertical axis.
- b) When the motor starts and stops frequently.
- c) When load inertia exceeds the allowable load inertia on the motor side.
- d) When the motor rotates at a speed higher than the rated speed (3000 r/min).

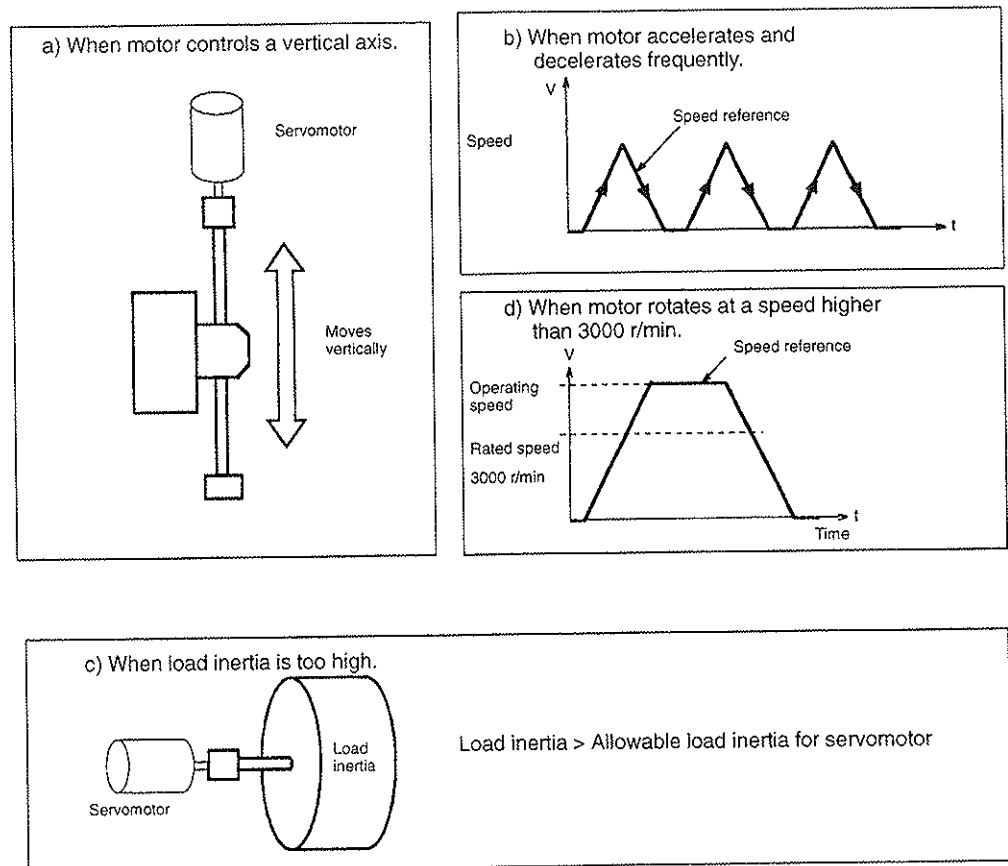

## 3) "How can we Determine Whether a Regenerative Unit is Required or Not?"

Using software "regenerative capacity check program" enables the user to easily determine whether a regenerative unit is required. This software is included as part of Yaskawa proprietary software "AC servomotor sizing software," which is supplied free of charge. Use this software as necessary.

4) Connecting a Regenerative Unit (JUSP-RG08 type)

The standard connection diagram for a regenerative unit (JUSP-RG08) is shown below.

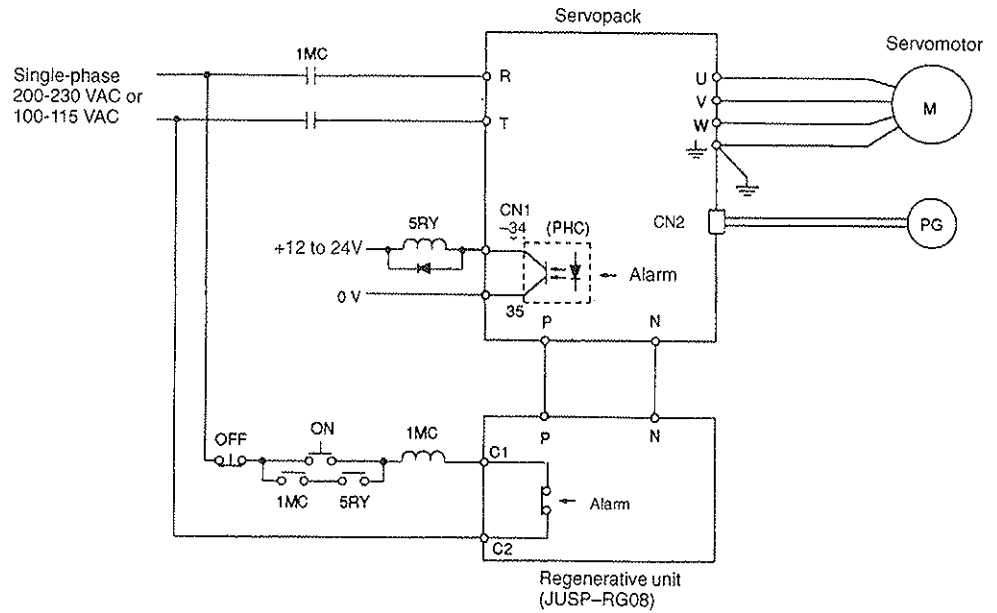

a) A regenerative unit has the following fault detection functions:

- Detecting disconnection in a regenerative resistor
- Detecting faults in a regenerative transistor
- Detecting overvoltage

b) When one of these fault detection functions operates, the internal alarm relay is actuated. Then, the circuit between output terminals C1 and C2 is opened.

c) Form a sequence so that the Servopack power is turned OFF when the alarm relay is actuated.

## 5) Connecting a Regenerative Unit (JUSP-RG08C type)

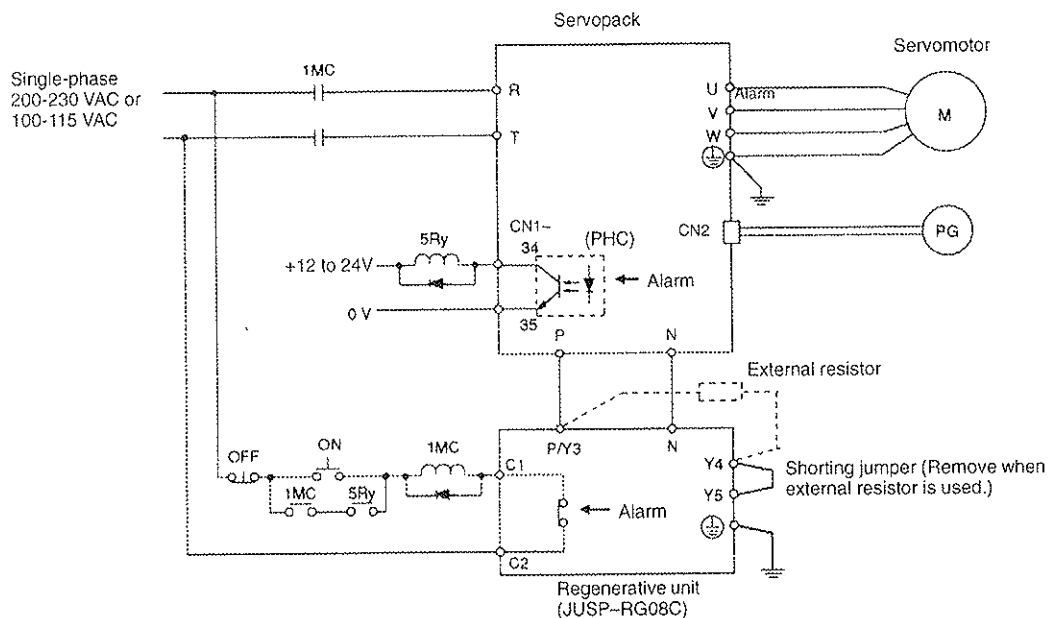

- a) A regenerative unit has the following fault detection functions:
- Detecting disconnection in a regenerative resistor
  - Detecting faults in a regenerative transistor
  - Detecting overvoltage
- b) When one of these fault detection functions operates, the internal alarm relay is actuated. Then, the circuit between output terminals C1 and C2 is opened.
- c) When an external resistor is used, remove the shorting jumper between Y4 and Y5. Then, connect the resistor between P/Y3 and Y4.
- d) The resistance value of the external resistor should be  $50\Omega$  min.

## 2.6.5 Using SGDL Servopack with High Voltage Line

- 1) SGDL Servopacks are divided into single-phase 200 V and single-phase 100 V types according to supply voltage.

If, however, three-phase 400 VAC class (400 V, 440 V) power supply must be used, prepare the following power transformer (for single-phase).

<Primary side>		<Secondary side>
1) 400 or 440 VAC	→	200 VAC
2) 400 or 440 VAC	→	100 VAC

## APPLICATIONS OF $\Sigma$ -L SERIES PRODUCTS

### 2.6.5 Using SGDL Servopack with High Voltage Line cont.

2) Select appropriate power transformer capacity according to the following table.

Supply Voltage	Servopack Type	Power Supply Capacity Per SGDE Servopack (kVA) (see note)
200 V	SGDL-A3AS	0.25
	SGDL-A5AS	0.3
	SGDL-01AS	0.5
	SGDL-02AS	0.75
	SGDL-04AS	1.2
	SGDL-08AS	2.2
100 V	SGDL-A3BS	0.2
	SGDL-A5BS	0.3
	SGDL-01BS	0.5
	SGDL-02BS	0.75
	SGDL-03BS	1.4

**Note** At rated load.

3) When 400-V-class supply voltage is used, power must be turned ON and OFF on the primary side of the power transformer.

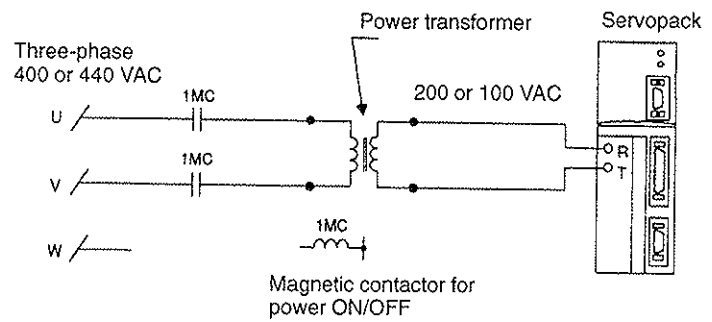



## 2.6.6 Connector Terminal Layouts

This section describes connector terminal layouts for Servopacks and Servomotors.

### 1) Servopack Connectors

#### CN1 Terminal Layout

2	SG	Torque reference input 0 V	1	T-REF	Torque reference input	20	PAO	PG output phase A	19	SG	PG output signal 0V
4	SG	Speed reference input 0 V	3	V-REF	Speed reference input	22	PBO	PG output phase B	21	*PAO	PG output phase A
6	---	Not used	5	---	Not used	24	PCO	PG output phase C	23	*PBO	PG output phase B
8	---	Not used	7	BK	Brake interlock signal output	26	---	Not used	25	*PCO	PG output phase C
10	SG-COM	BK/V-CMP/TGON common 0 V	9	TGON	TGON signal output	28	---	Not used	27	---	Not used
12	N-CL	Reverse external torque limit ON input	11	P-CL	Forward external torque limit ON input	30	ALO1	Alarm code output (open collector output)	29	---	Not used
14	S-ON	Servo ON input	13	+24 V IN	External power supply input	32	ALO3		31	ALO2	Alarm code output (open collector output)
16	P-OT	Forward rotation prohibited	15	P-CON	P control input	34	ALM	Servo alarm output	33	SG-AL	Alarm code output common 0 V
18	ALMRST	Alarm reset input	17	N-OT	Reverse rotation prohibited	36	FG	Frame ground	35	ALM-SG	Servo alarm output

- **Servopack Side** Connector type: 10236-52A2JL (manufactured by 3M)
- **Cable Side** Connector type: 10136-3000VE (manufactured by 3M)  
Connector case type: 10336-52A0-008 (manufactured by 3M)

#### CN2 Terminal Layout

2	PG0V	PG power supply 0 V	1	PG0V	PG power supply 0 V	12	---	Not used	11	---	Not used
4	PG5V	PG power supply +5 V	3	PG0V	PG power supply +5 V	14	PC	PG input phase C	13	---	Not used
6	PG5V		5	PG5V		16	PA	PG input phase A	15	*PC	PG input phase C
8	---	Not used	7	---	Not used	18	PB	PG input phase B	17	*PA	PG input phase A
10	---	Not used	9	---	Not used	20	FG	Frame ground	19	*PB	PG input phase B

- **Servopack Side** Connector type: 10220-52A2JL (manufactured by 3M)
- **Cable Side** Connector type: 10120-3000VE (manufactured by 3M)  
Connector case type: 10320-52A0-008 (manufactured by 3M)

2

2) Connectors for Incremental Encoder

1	Channel A output	Blue
2	Channel A output	Blue/Black
3	Channel B output	Yellow
4	Channel B output	Yellow/Black
5	Channel C output	Green
6	Channel C output	Green/Black
7	0 V (power supply)	Gray
8	+5 V (power supply)	Red
9	Frame ground (FG)	Orange



Items to be Prepared by Customer  
 Cap: 172161-1  
 Socket: 170361-1 (chain type) or  
 170365-1 (loose type)

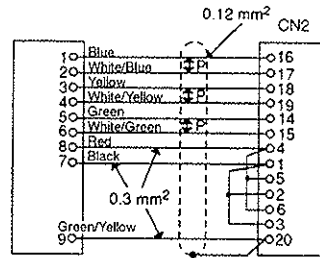
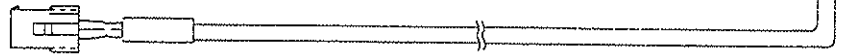
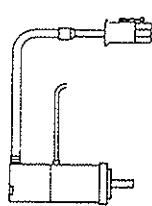
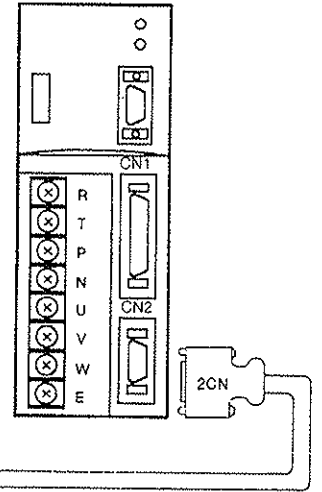

Items to be Prepared by Customer  
 Case: 10320-52A0-008  
 (manufactured by 3M)  
 Connector: 10120-3000VE  
 (manufactured by 3M)

3) Connectors and Terminals for Standard-type Motor without Brake

1	Phase U	Red
2	Phase V	White
3	Phase W	Blue
4	Frame ground (FG)	Green



Cap: 172159-1  
 Socket: 170362-1 or  
 170366-1

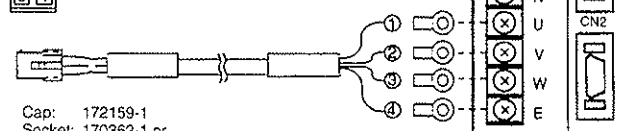
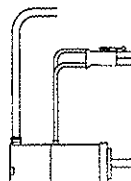

M4 crimp terminal

Items to be Prepared by Customer  
 Round crimp terminal R1.25-4TOR  
 (manufactured by AMP)

### 4) Connectors and Terminals for Motor with Brake

1	Phase U	Red
2	Phase V	White
3	Phase W	Blue
4	Frame ground (FG)	Green
5	Brake terminal	Black
6	Brake terminal	Black

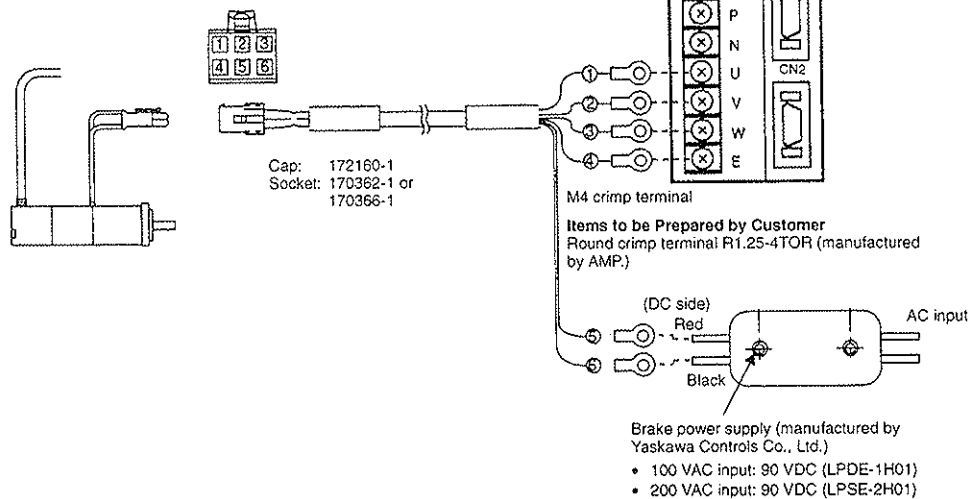

2



# USING THE DIGITAL OPERATOR

# 3

This chapter describes the basic operation of the digital operator and the convenient features it offers.

All constant settings and motor operations are possible by simple, convenient, operation.

Operate the digital operator as you read through this chapter.

<b>3.1 Basic Operations</b> .....	<b>98</b>
3.1.1 Connecting the Digital Operator .....	98
3.1.2 Resetting Servo Alarms .....	99
3.1.3 Basic Functions and Mode Selection .....	100
3.1.4 Operation in Status Display Mode .....	101
3.1.5 Operation in User Constant Setting Mode .....	102
3.1.6 Operation in Monitor Mode .....	107
<b>3.2 Using the Functions</b> .....	<b>110</b>
3.2.1 Operation in Alarm Trace-back Mode .....	110
3.2.2 Operation Using the Digital Operator .....	112
3.2.3 Autotuning .....	115
3.2.4 Clearing Alarm Trace-back Data .....	121
3.2.5 Checking Motor Type .....	122
3.2.6 Checking Software Version .....	123
3.2.7 Speed Reference Offset Automatic Adjustment .....	123
3.2.8 Speed Reference Offset Manual Adjustment Mode .....	126

## 3.1 Basic Operations

▣ This section describes the basic operations using the Digital Operator.

3.1.1	Connecting the Digital Operator .....	98
3.1.2	Resetting Servo Alarms .....	99
3.1.3	Basic Functions and Mode Selection .....	100
3.1.4	Operation in Status Display Mode .....	101
3.1.5	Operation in User Constant Setting Mode .....	102
3.1.6	Operation in Monitor Mode .....	107

### 3.1.1 Connecting the Digital Operator

The Digital Operator is available as two types: JUSP-OP02A-1 (Hand-held Type) and JUSP-OP03A (Mount Type).

Each type is connected to the Servopack as shown below.

JUSP-OP02A-1 (Hand-held Type)

JUSP-OP03A (Mount Type)

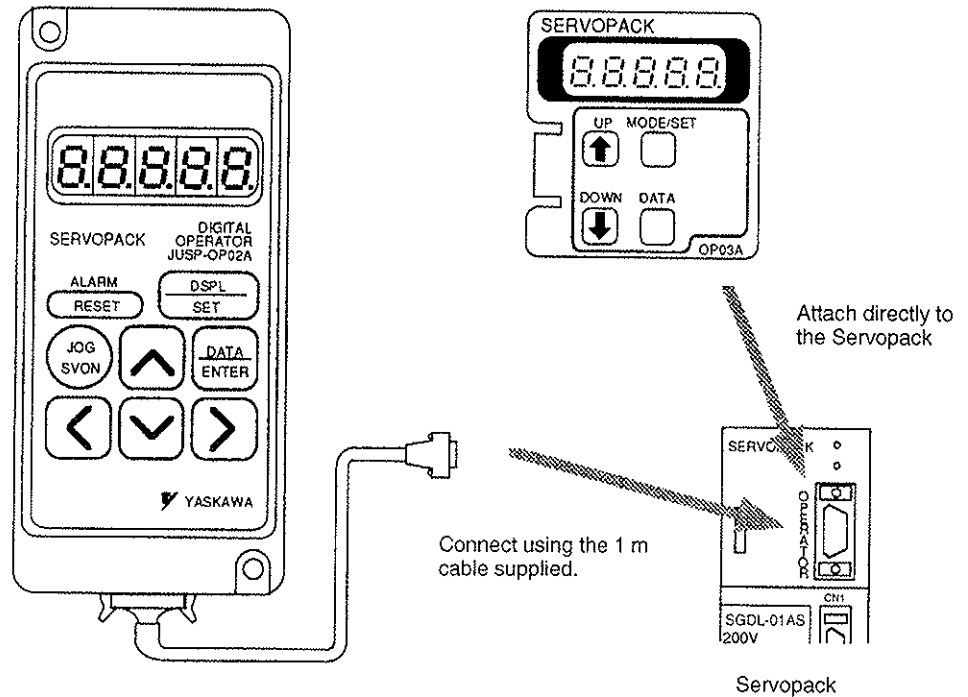

- The Digital Operator connector can be connected or disconnected while the Servopack power is ON.

### 3.1.2 Resetting Servo Alarms

Servo alarms can be reset using the Digital Operator. (Servo alarms can also be reset by the CN1-18,  $\overline{\text{ALMRST}}$  input signal. Refer to 2.5.1 *Using Servo Alarm Output and Alarm Code Output* for details.)

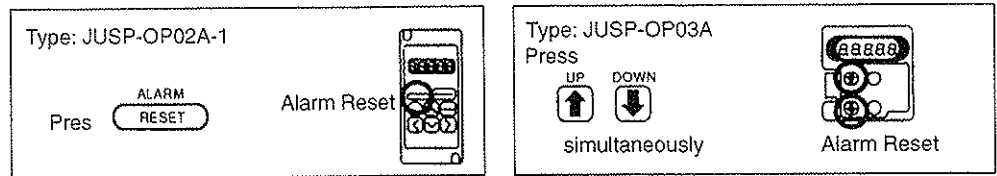

**NOTE** After an alarm occurs, remove the cause of the alarm before resetting it. Refer to *Section 5.2 Troubleshooting* to determine and remedy the cause of an alarm.

### 3.1.3 Basic Functions and Mode Selection

Digital Operator operation allows status display, user constant setting, operating reference, and auto-tuning operations.

#### Basic Mode Selection

The four basic modes are listed below. Each time the mode key is pressed, the next mode in the sequence is selected.

JUSP-OP02A-1

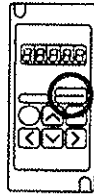

Press the



key to switch the mode.

JUSP-OP03A

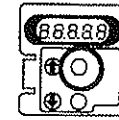

Press the



key to switch the mode.

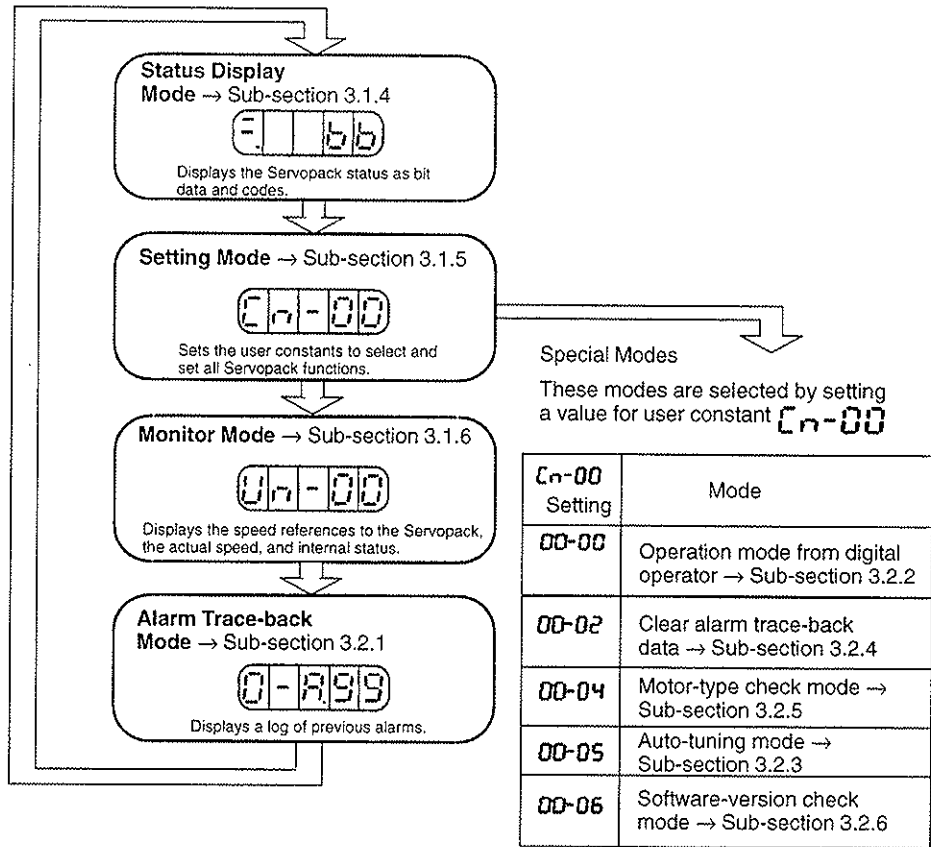



### 3.1.4 Operation in Status Display Mode

The status display mode displays the Servopack status as bit data and codes.

- Selecting Status Display Mode

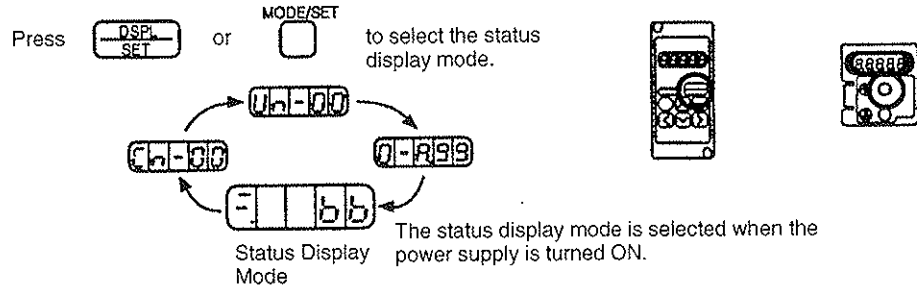

Keys to the status display are shown below.

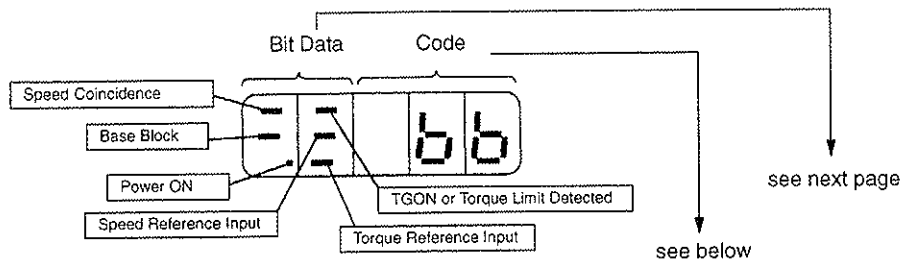

Code	Status
	Base block Servo OFF (motor power OFF)
	Run Servo ON (motor power ON)
	Forward Rotation Prohibited (P-OT) CN1-16 (P-OT) OFF. See Cn-01 Bit 2 (page 36).
	Reverse Rotation Prohibited (N-OT) CN1-17 (N-OT) OFF. See Cn-01 Bit 3 (page 36).
	Alarm Status Displays the alarm number.

Bit Data	Description
Power ON	Lit when Servopack power ON. Not lit when Servopack power OFF.
Base Block	Lit for base block. Not lit at servo ON.
Speed Coincidence	Lit if motor speed reaches speed reference. Otherwise, not lit.
TGON or Torque Limit Detected (selected by Cn-01 Bit 4)	<p>Lit if motor speed exceeds preset value. Not lit if motor speed is below preset value. Preset value: Set in Cn-0B (20 r/min is factory setting)</p> <p>Lit if Servopack internal torque reference exceeds preset value. Not lit if Servopack internal torque reference is below preset value. Preset value: Set in Cn-08, -09 (max. torque is standard setting) Cn-18 is preset value during CN1-11 (<math>\overline{P-CL}</math>) input. Cn-19 is preset value during CN1-12 (<math>\overline{N-CL}</math>) input. Not lit during torque control.</p>
Speed Reference Input	Lit if input speed reference exceeds preset value. Not lit if input speed reference is below preset value. Specified value: Set in Cn-0B (20 r/min is factory setting)
Torque Reference Input	Lit if input torque reference exceeds preset value. Not lit if input torque reference is below preset value. Preset value: Set in Cn-0B (10% rated torque is standard setting)

### 3.1.5 Operation in User Constant Setting Mode

- 1) Two types of user constant are used
  - a) Constant Settings (Cn-03 to Cn-23)
  - b) Memory Switches (Cn-01, Cn-02)

The setting method is different for each type.

The Servopack offers a large number of functions, which are selected and adjusted by the user constant settings.

The constant settings (Cn-03 to Cn-23) allow setting of a constant within a fixed range.

The memory switches (Cn-01, Cn-02) allow the required functions to be selected.

Refer to *Appendix C List of User Constant Settings*.

## 2) Using the Setting Mode for Constant Settings (Cn-04 to Cn-26)

The constant settings (Cn-04 to Cn-26) allow setting of a constant. Check the permitted range of the constant in *Appendix C List of User Constant Settings*, before changing the data. The example below shows how to change user setting Cn-04 from 80 to 40.



JUSP-OP02A-1

### For JUSP-OP02A-1

- 1) Press to select the user constant setting mode.

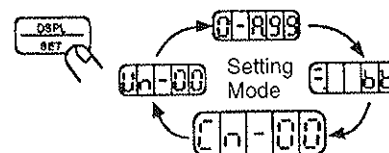

- 2) Select the user constant number to set.  
Press the and keys to select the digit.  
Press the and keys to change the value.

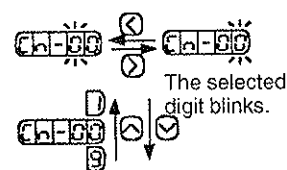

- 3) Press to display the current data for the user constant selected at step 2.

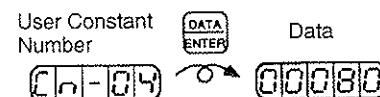

- 4) Set the required data.  
Press the and keys to select the digit.  
Press the and keys to change the value.

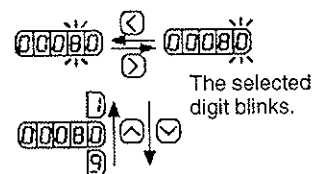

- 5) Press to store the data.

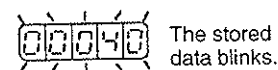

- 6) Press once more to display the user constant number again.

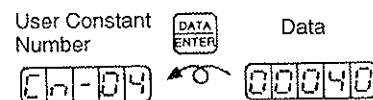

- 7) Repeat steps 2 to 6 as often as required.

## USING THE DIGITAL OPERATOR

### 3.1.5 Operation in User Constant Setting Mode cont.



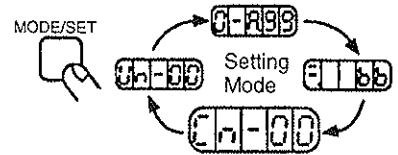

#### For JUSP-OP03A

1) Press  to select the user constant setting mode.



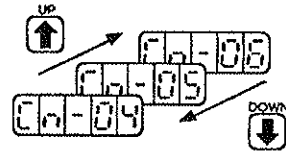

2) Press the  and  keys to select the user constant number to set.

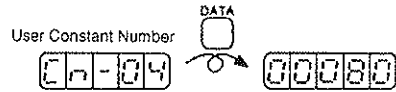

3) Press  to display the current data for the user constant selected at step 2.



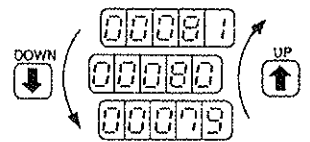

4) Press the  and  keys to change the data to the required value.

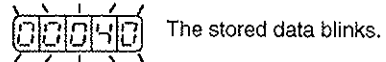

Value changes rapidly when key held down

5) Press  to store the data.



6) Press  once more to display the user constant number again.

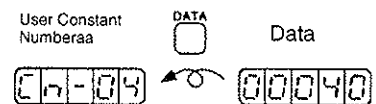

7) Repeat steps 2 to 6 as often as required.

- Refer to *Appendix C List of User Constant Settings*

### 3) Using the Setting Mode for Memory Switches (Cn-01, Cn-02)

Turn the bits of the memory switches ON and OFF to select the functions required. The example below shows how to turn ON Bit 3 of memory switch Cn-01.



JUSP-OP02A-1

#### For JUSP-OP02A-1

1) Press to select the user constant setting mode.

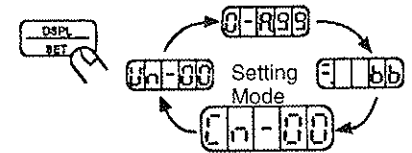

2) Select the user constant number to set.  
Press the and keys to select the digit.  
Press the and keys to change the value.

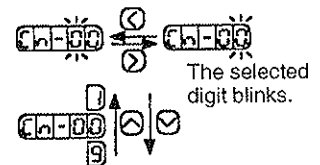

3) Press to display the current data for the memory switch selected at step 2.

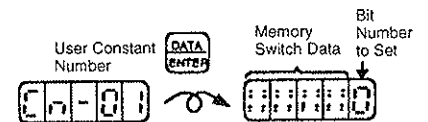

4) Press the and keys to select the bit number to set.

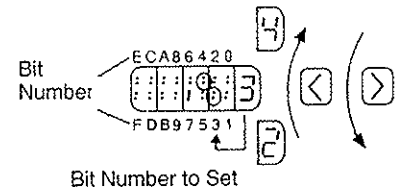

5) Press the and keys to set the memory switch data ON or OFF for the bit number.

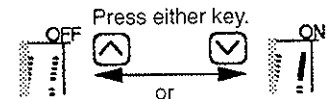

6) Repeat steps 4 and 5 as often as required.

7) Press to store the data.

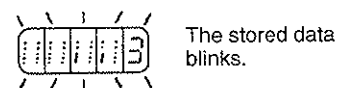

#### Turning Bits ON and OFF

Memory switches use bits, not numbers, to select functions.

Sixteen bits are available (1 to 9 and A to E). Select the required functions by turning the appropriate bit ON (function ON) or OFF (function OFF).

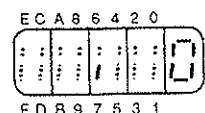

⋮ = OFF  
I = ON

# USING THE DIGITAL OPERATOR

## 3.1.5 Operation in User Constant Setting Mode cont.

- 8) Press  once more to display the user constant number again.

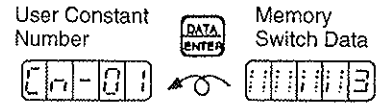

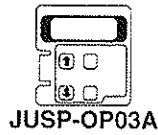

• Refer to *Appendix C List of User Constant Settings*.



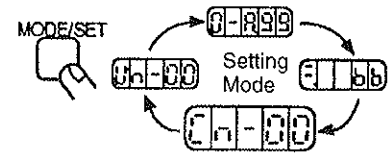

### For JUSP-OP03A

- 1) Press  to select the user constant setting mode.



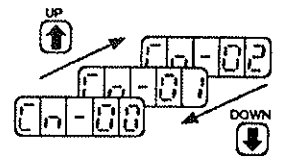

- 2) Press the  and  keys to select the user constant number to set.

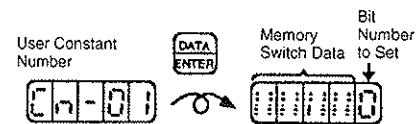

- 3) Press  to display the current data for the memory switch selected at step 2.



- 4) Press the  and  keys to select the bit number to set.

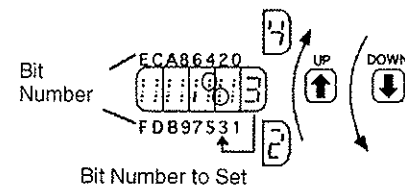

- 5) Press  to set the memory switch data ON or OFF for the bit number.



- 6) Repeat steps 4 and 5 as often as required.

- 7) Press  to store the data.



- 8) Press  once more to display the user constant number again.

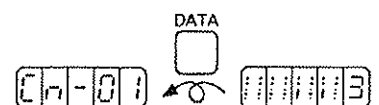

• Refer to *Appendix C List of User Constant Settings*

### 3.1.6 Operation in Monitor Mode

- 1) The monitor mode allows the reference values input into the Servopack, I/O signal status, and Servopack internal status to be monitored.  
The monitor mode can be set during motor operation.

#### 2) Using the Monitor Mode

The example below shows how to display 1500, the contents of monitor number Un-00.





JUSP-OP02A-1

#### For JUSP-OP02A-1

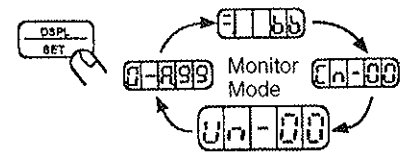
- 1) Press  to select the monitor mode



- 2) Press the  and  keys to select the monitor number to display.

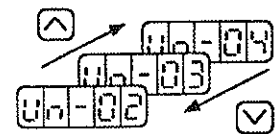

- 3) Press  to display the data for the monitor number selected at step 2.



- 4) Press  once more to display the monitor number again.

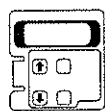



JUSP-OP03A

#### For JUSP-OP03A

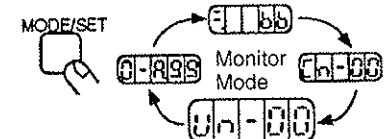
- 1) Press  to select the monitor mode.



- 2) Press the  and  keys to select the monitor number to display.

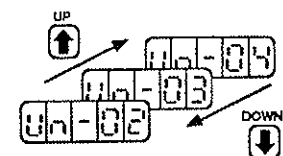

- 3) Press  to display the data for the monitor number selected at step 2.

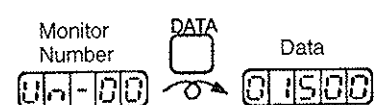

- 4) Press  once more to display the monitor number again.



## USING THE DIGITAL OPERATOR

### 3.1.6 Operation in Monitor Mode cont.

3) Keys to Monitor Mode Display are shown below.

Monitor Number	Monitor Display
Un-00	Actual motor speed Units: r/min.
Un-01	Input speed reference Units: r/min.
Un-02	Internal torque reference Units: % (with respect to rated torque)
Un-03	Number of pulses from motor U-phase edge Units: pulses
Un-04	Electrical angle Units: deg
Un-05	Internal status bit display

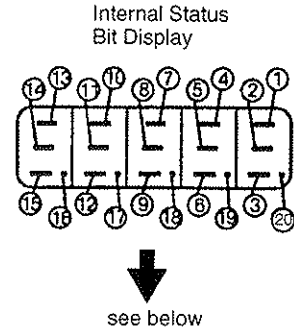

Bit #	Description	Related I/O Signal, User Constant
1	Servo alarm	CN1-34(ALM)
2	Dynamic brake ON	
3	Reverse rotation mode	Cn-02 Bit 0, CN2-7(DIR)
4	During motor rotation or torque limit	CN1-9 (TG-ON), status display mode
5	Not used	
6	Mode switch ON	
7	During forward current limit	Or contact input speed control CN1-11 (P-CL)
8	During reverse current limit	
9	Motor power ON	
10	A-phase	CN2-16(PA), CN2-17(*PA)
11	B-phase	CN2-18(PB), CN2-19(*PB)
12	C-phase	CN2-14(PC), CN2-15(*PC)
13	U-phase	
14	V-phase	
15	W-phase	
16	Servo ON	CN1-14 (S-ON) , Cn-01 Bit 0
17	P operation, zero clamp, or rotation direction input	CN1-15 (P-CON) , Cn-01 Bit A, B, Cn-02 Bit 2
18	Forward overtravel	CN1-16 (P-OT), Cn-01 Bit 2
19	Reverse overtravel	CN1-17 (N-OT), Cn-01 Bit 3
20	SEN signal input	CN1-5 (SEN)



Un-06	1	Input reference pulse	CN1-1 (PLUS), CN1-2(*PULS)
	2	Input pulse sign	CN1-3(SIGN), CN1-4 (*SIGN)
	3	Error counter clear input	CN1-5 ( $\overline{\text{CLR}}$ ), CN1-6(*CLR)
	4 to 20	Not used	

## 3.2 Using the Functions

This section describes how to use the basic operations described in section 1 to operate and adjust the motor.

3.2.1	Operation in Alarm Trace-back Mode .....	110
3.2.2	Operation Using the Digital Operator .....	112
3.2.3	Autotuning .....	115
3.2.4	Clearing Alarm Trace-back Data .....	121
3.2.5	Checking Motor Type .....	122
3.2.6	Checking Software Version .....	123
3.2.7	Speed Reference Offset Automatic Adjustment .....	123
3.2.8	Speed Reference Offset Manual Adjustment Mode .....	126

### 3.2.1 Operation in Alarm Trace-back Mode

- 1) The alarm trace-back mode displays up to ten alarms which occurred previously. By allowing confirmation of what alarm occurred when, it is a useful aid to speed up troubleshooting.

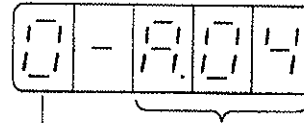

Alarm Sequence Number  
The higher the number,  
the older the alarm data

Alarm Code

Refer to *Section 5.2*  
for troubleshooting.

**NOTE** The alarm trace-back data are not cleared on alarm reset or when the Servopack power is turned OFF. This does not adversely affect operation. The data are cleared using the special mode: Clear alarm trace-back data. Refer to sub-section 3.2.4 for details.

Alarms CPF00 and CPF01 are not stored as alarm trace-back data, since they are operator-related alarms.

## 2) Using the Alarm Trace-back Mode

Follow the procedure below to determine which alarms occurred previously.





JUSP-OP02A-1

## For JUSP-OP02A-1

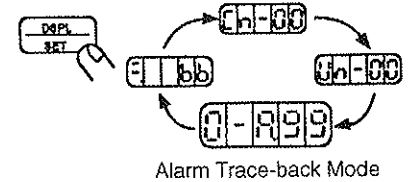
- 1) Press  to select the alarm trace-back mode.



- 2) Press the  and  keys to scroll the alarm sequence numbers up and down and display information on previous alarms. The higher the left-hand digit (alarm sequence number), the older the alarm data.

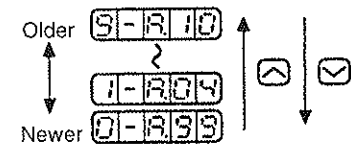



JUSP-OP03A

## For JUSP-OP03A

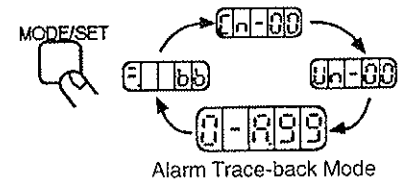
- 1) Press  to select the alarm trace-back mode.



- 2) Press the  and  keys to scroll the alarm sequence numbers up and down and display information on previous alarms. The higher the left-hand digit (alarm sequence number), the older the alarm data.

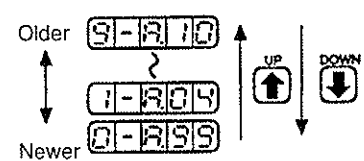

**NOTE** Refer to *Section 5.2* for troubleshooting.

### 3.2.2 Operation Using the Digital Operator



#### Simple Motor Check

Operation from the Digital Operator allows the Servopack to run the motor. This allows rapid checking of basic operations during machine set-up and testing, without the trouble of connecting a host controller.

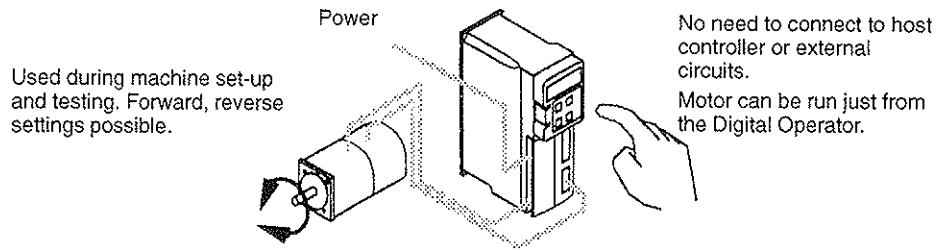

**NOTE** SGME Servomotor runs at 500 r/min. The motor speed cannot be changed.

#### 1) Operation Using the Digital Operator

Use the following procedure to operate the motor from the Digital Operator

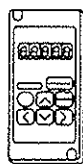

JUSP-OP02A-1

#### For JUSP-OP02A-1

1) Press to select the user constant setting mode.

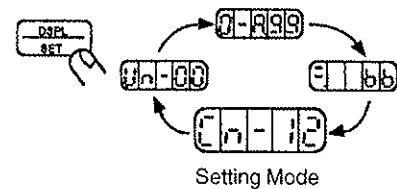

2) Select the user constant number Cn-00. (User constant Cn-00 is selected when the power is turned ON.)

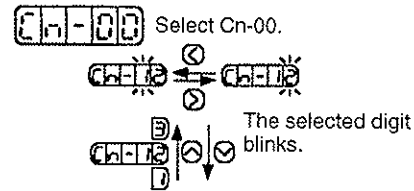

Press the and keys to select the digit.

Press the and keys to change the value.

3) Press to display the current data for the user constant Cn-00.



- 4) Press the and keys to change the data to 00.  
(This user constant is set to 00 when the power is turned ON.)

Set to 00-00.

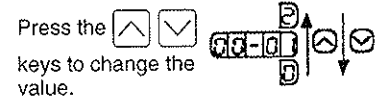

- 5) Press to set the Digital Operator in operation mode. Operation is now possible under Digital Operator control.

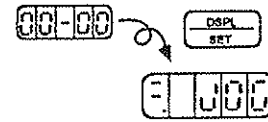

Display for operation mode from Digital Operator

- 6) Press to set the servo ON status (motor power turned ON).

**Select Servo ON/Servo OFF**

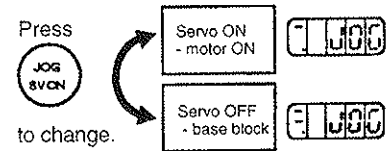

- 7) Press the and keys to operate the motor.

**Motor Forward/Reverse Rotation**

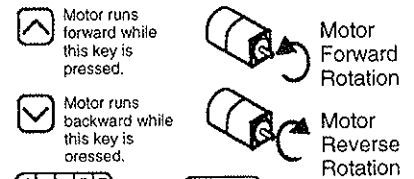

- 8) Press to revert to . This sets the servo OFF status (motor power turned OFF).

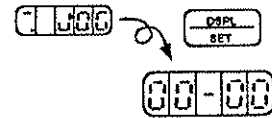

(Alternatively, press to set the servo OFF status.)

- 9) Press to return to the setting mode display. This disables operation under Digital Operator control.

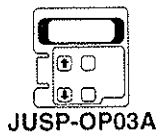
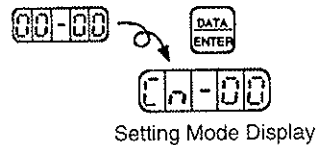

**For JUSP-OP03A**

- 1) Press to select the user constant setting mode.

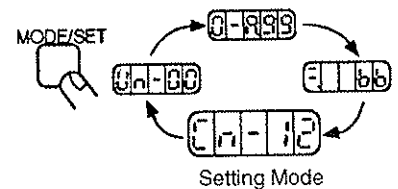

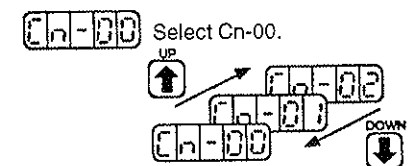

- 2) Press the and keys to select the user constant number Cn-00.  
(User constant Cn-00 is selected when the power is turned ON.)

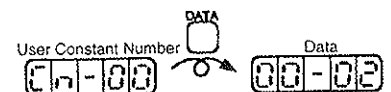

- 3) Press to display the current data for the user constant Cn-00.



- 4) Press the  and  keys to change the data to 00.  
(This user constant is set to 00 when the power is turned ON.)

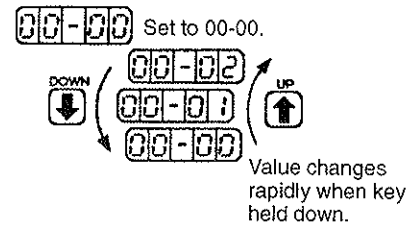

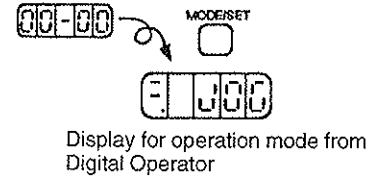

- 5) Press  to set the Digital Operator in operation mode. Operation is now possible under Digital Operator control.

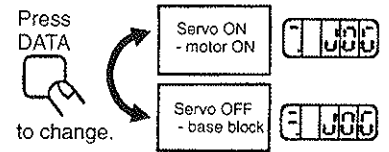

- 6) Press  to set the servo ON status (motor power turned ON).



**Select Servo ON/Servo OFF**

- 7) Press the  and  keys to operate the motor.

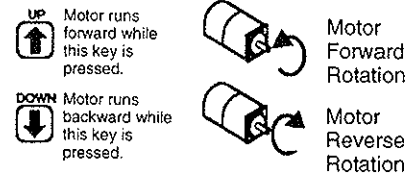

**Motor Forward/Reverse Rotation**

- 8) Press  to revert to 00-00. This sets the servo OFF status (motor power turned OFF).

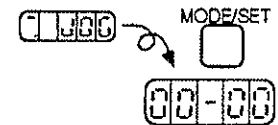

(Alternatively, press  to set the servo OFF status.)

- 9) Press  to return to the setting mode display. This disables operation under Digital Operator control.

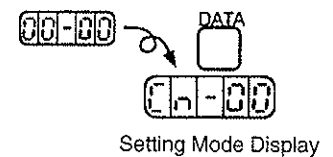

### 3.2.3 Autotuning



#### No experience required to achieve optimum settings.

The Servopack contains a built-in autotuning function to automatically measure the machine characteristics and set the user constants.

Servo drives normally require tuning to match the machine configuration and rigidity. This tuning requires a great deal of experience and is difficult for a person unfamiliar with the tuning procedure.

However, autotuning allows even totally inexperienced people to easily complete the tuning.

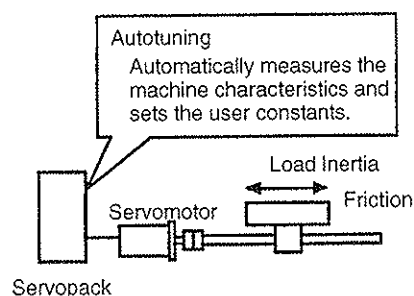

Autotuning is similar to auto-focus for a camera.

#### 1) User Constants Automatically Settable with Autotuning

Cn-04	Speed loop gain
Cn-05	Speed loop integration time constant

Once autotuning has been completed, the autotuning procedure can be omitted for subsequent machines, providing the machine specifications remain unchanged.

It is sufficient to directly set the user constants for subsequent machines.

The **machine rigidity** can be selected from one of seven levels.

- NOTE**
- Conduct autotuning with the motor attached to the machine. Make sure that the machine is ready for operation and take sufficient safety precautions when operating the machine.
  - Make sure that the  $\overline{\text{P-CON}}$  signal is OFF (PI control is selected) before starting autotuning.



#### Machine Rigidity

The machine rigidity is one of the machine characteristics related to servo control. Set the servo to high response for a machine, such as a machine tool, with high rigidity, and to low response for a machine, such as a robot, with low rigidity.

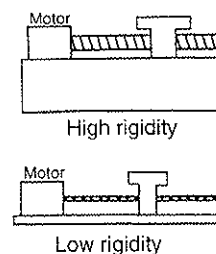

2) Using Autotuning

Follow the procedure below to run autotuning.



JUSP-OP02A-1

For JUSP-OP02A-1

- 1) Press to select the user constant setting mode.

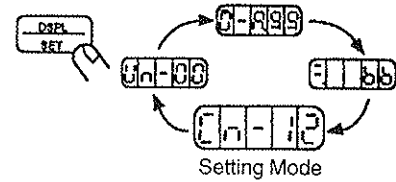

- 2) Select the user constant number Cn-00. (User constant Cn-00 is selected when the power is turned ON.)

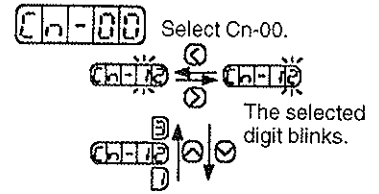

Press the and keys to select the digit.

Press the and keys to change the value.

- 3) Press to display the current data for the user constant Cn-00.

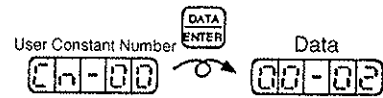

- 4) Press the and keys to change the data to 05.

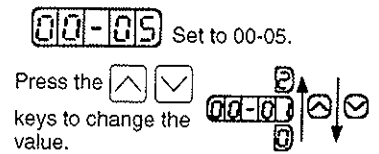

- 5) Press to display the machine rigidity.

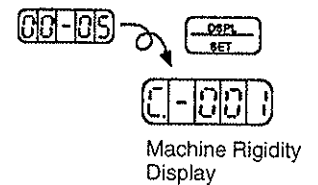

- 6) Press the and keys to select the machine rigidity. If the actual rigidity is unknown, select medium rigidity.

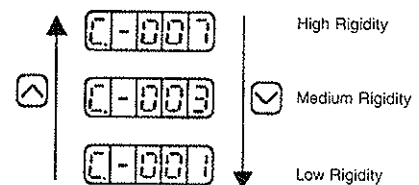

- 7) Press to select autotuning mode.

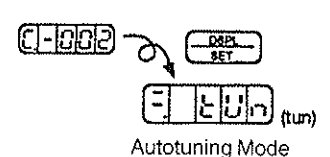



8) Press  to set the servo ON status.

**Select Servo ON/Servo OFF**

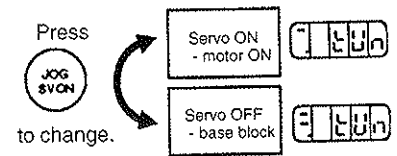

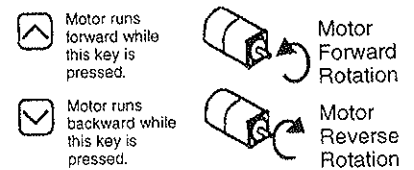

9) Press the  and  keys to operate the motor.

**Motor Forward/Reverse Rotation**

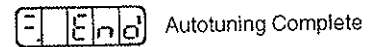

10) When autotuning is complete, the END message is displayed, as shown to the right. Servo OFF status is automatically selected. If Servo ON/Servo OFF is selected by a signal from an external contact, turn this signal OFF.

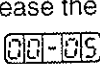

11) Release the  and  keys to revert to the  display.

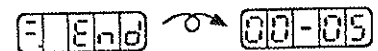

12) Press  to return to the setting mode display. This ends the autotuning operation.

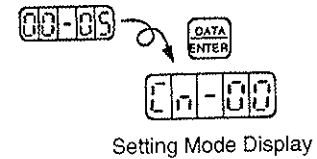



- Refer to sub-section 3) on page 119 for the precautions relating to autotuning.



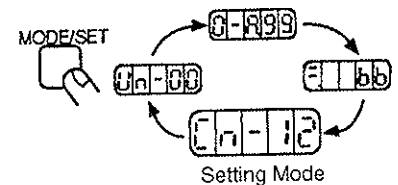

**For JUSP-OP03A**

1) Press  to select the user constant setting mode.

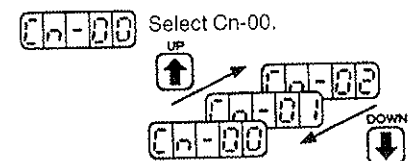

2) Press the  and  keys to select the user constant number Cn-00. (User constant Cn-00 is selected when the power is turned ON.)



3) Press  to display the current data for the user constant Cn-00.

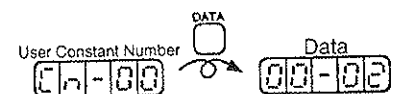

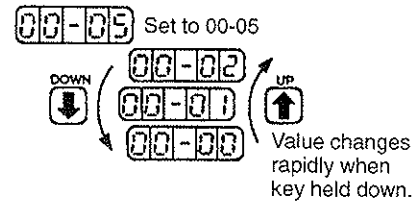

- 4) Press the  and  keys to change the data to 05.

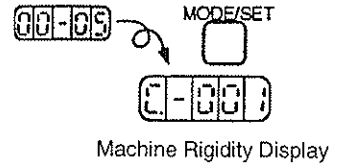

- 5) Press  to display the machine rigidity.



- 6) Press the  and  keys to select the machine rigidity.

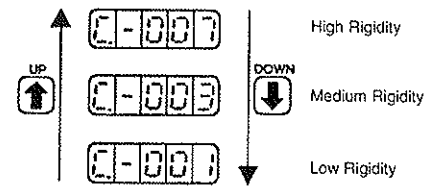

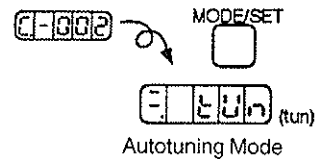

- 7) Press  to select autotuning mode.

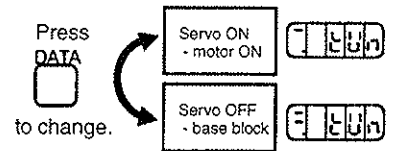

- 8) Press  to set the servo ON status.

**Select Servo ON/Servo OFF**



- 9) Press the  and  keys to operate the motor.

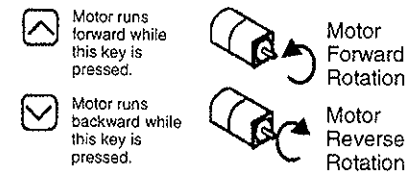

**Motor Forward/Reverse Rotation**



- 10) When autotuning is complete, the END message is displayed, as shown to the right.

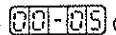

Servo OFF status is automatically selected. If Servo ON/Servo OFF is selected by a signal from an external contact, turn this signal OFF.

- 11) Release the  and  keys to revert to the  display.



- 12) Press  to return to the setting mode display. This ends autotuning operation.

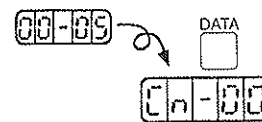





Setting Mode Display

- Refer to the following sub-section 3) for the precautions relating to autotuning.

### 3) Precautions Relating to Autotuning

#### a) Speed Setting During Autotuning

The motor speed during autotuning is 500 r/min.

The motor runs intermittently while the  or  (or  or ) key is held down. The motor does not rotate continuously.

#### b) Machine Rigidity Selection







Select the machine rigidity as described below. If the actual rigidity is unknown, select medium rigidity.

 High Rigidity

 Medium Rigidity



 Low Rigidity

- If the Machine Resonates

At servo ON when the  (or ) key is pressed or when the motor is operated by pressing the  or  ( or ) key, machine resonance indicates an inappropriate machine rigidity setting.

Follow the procedure below to correct the machine rigidity setting, and run autotuning once more.

- (1) Press the  (or ) key to cancel autotuning.

- (2) Press the  (or ) key once more to enter the machine rigidity setting mode. Reduce the setting by one.

- If Autotuning Does Not End

Failure of autotuning to end  $\boxed{E} \boxed{n} \boxed{d}$ , is caused by an inappropriate machine rigidity setting. Follow the procedure below to correct the machine rigidity setting, and run autotuning once more.

(1) Press the  $\boxed{DSPL} \boxed{SET}$  (or  $\boxed{MODE/SET}$ ) key to cancel autotuning.

(2) Press the  $\boxed{DSPL} \boxed{SET}$  (or  $\boxed{MODE/SET}$ ) key once more to enter the machine rigidity setting mode. Increase the setting by one.

Autotuning may not end for machines with large play or extremely low rigidity. In these cases, use conventional manual adjustment.

c) Input Signals

- The OT signal is enabled during autotuning. Input the OT signal during autotuning. To conduct autotuning without inputting these signals, set user constant Cn-01 Bits 2 and 3 to 1.
- Autotuning is not possible during overtravel (P-OT or N-OT signal OFF).

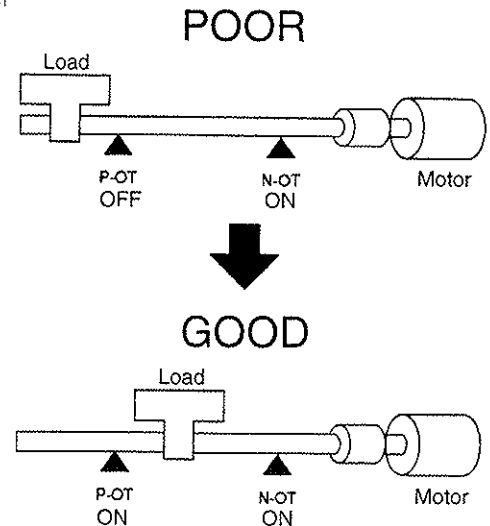

- Conduct autotuning when no overtravel has occurred (both P-OT and N-OT signal ON).

- Set the  $\overline{P-CON}$  signal OFF during autotuning.

- If using the  $\overline{S-ON}$  signal to set the servo ON status, display  $\boxed{E} \boxed{n} \boxed{d}$  before turning ON the  $\overline{S-ON}$  signal.

### 3.2.4 Clearing Alarm Trace-back Data

1) This procedure clears the alarm history, which stores the alarms occurring in the Servo-pack. Each alarm in the alarm history is set to A99, which is not an alarm code. Refer to 3.2.1 Operation in Alarm Trace-back Mode for details.

2) Follow the procedure below to clear the alarm trace-back data.

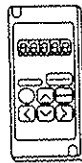

JUSP-OP02A-1

#### For JUSP-OP02A-1

1) Press to select the user constant setting mode.

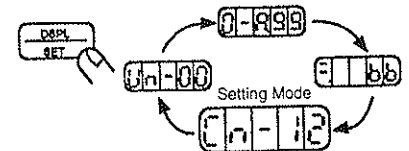

2) Select the user constant number Cn-00. (User constant Cn-00 is selected when the power is turned ON.)

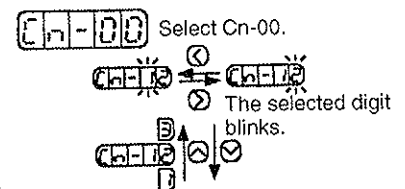

Press the and keys to select the digit.

Press the and keys to change the value.

3) Press to display the current data for the user constant Cn-00.



4) Press the and keys to change the data to 02.

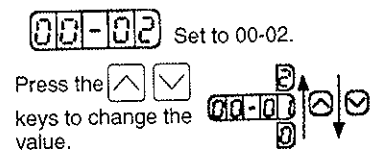

5) Press to clear the alarm trace-back data.



6) Press to return to the user constant data display.



JUSP-OP03A

#### For JUSP-OP03A

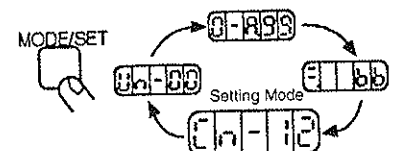

1) Press to select the user constant setting mode.





3

## USING THE DIGITAL OPERATOR

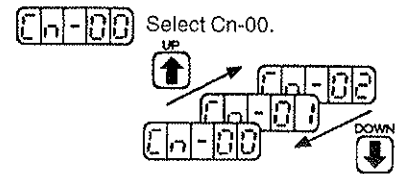

### 3.2.5 Checking Motor Type

- 2) Press the  and  keys to select the user constant number Cn-00.  
(User constant Cn-00 is selected when the power is turned ON.)

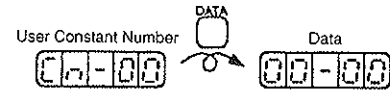

- 3) Press  to display the current data for the user constant Cn-00.



- 4) Press the  and  keys to change the data to 02.

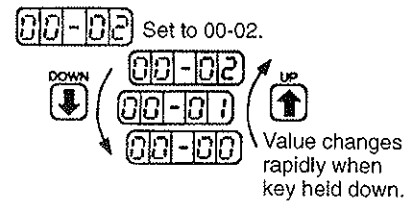

- 5) Press  to clear the alarm trace-back data.



Clear the alarm trace-back data.

- 6) Press  to return to the user constant data display.

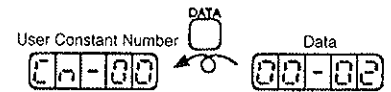

## 3.2.5 Checking Motor Type

Set Cn-00 to 00-04 to select the motor-type check mode.

This mode is used for maintenance and is not normally used by the customer.

Operation

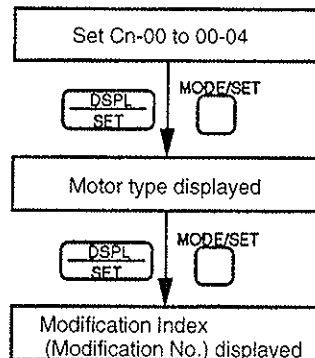

Motor Type Display

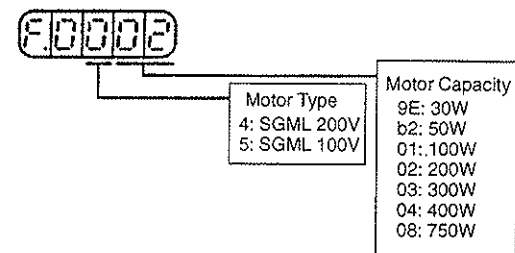

Modification Index (Modification No.) Display

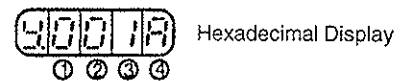

$$\textcircled{1} \times 16^3 + \textcircled{2} \times 16^2 + \textcircled{3} \times 16 + \textcircled{4} = \text{Modification index (Modification No.)}$$

### 3.2.6 Checking Software Version

- 1) Set Cn-00 to 00-06 to select the software-version check mode.  
This mode is used for maintenance and is not normally used by the customer.

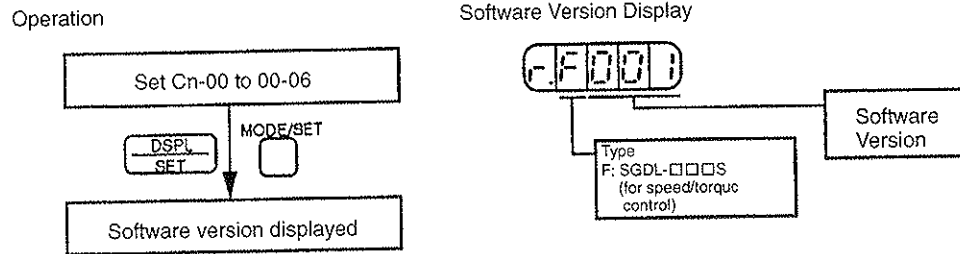

### 3.2.7 Speed Reference Offset Automatic Adjustment

- 1) Why Does Reference Offset Occur?  
Using a speed/torque control (SGDL-□□□S) type, the motor may rotate slowly when the reference voltage is intended to be 0 V.  
This occurs when the host controller or external circuit has a small offset (measured in mV) in the reference voltage.



#### Automatic Adjustment of Reference Voltage

The reference offset automatic adjustment mode automatically measures the offset and adjusts the reference voltage. It adjusts both speed and torque references.

The following diagram illustrates automatic adjustment of an offset in the reference voltage from the host controller or external circuit.

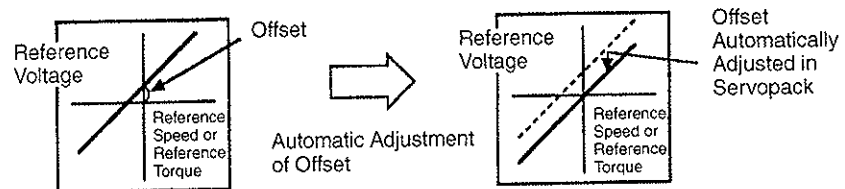

- 2) After completion of offset automatic adjustment, the amount of offset is stored in the Servopack.  
The amount of offset can be checked in the speed reference offset manual adjustment mode. Refer to sub-section 3.2.8 for details.

3) Using the Reference Offset Automatic Adjustment Mode

Follow the procedure below to automatically adjust the reference offset.

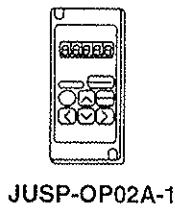

For JUSP-OP02A-1

1) Follow the procedure below to set the motor into operating mode.

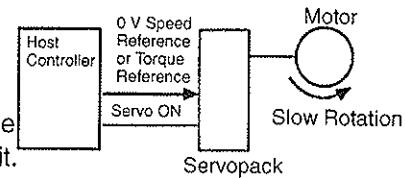

(1) Input the (intended) 0 V reference voltage from the host controller or external circuit.

(2) Then, turn ON the servo ON (CN1-14, S-ON) signal.

2) Press to select the user constant setting mode.

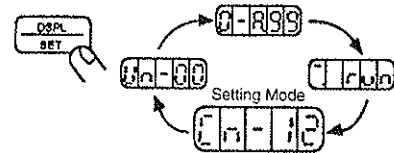

3) Select the user constant number Cn-00. (User constant Cn-00 is selected when the power is turned ON.)

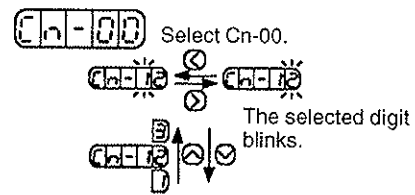

Press the and keys to select the digit.

Press the and keys to change the value.

4) Press to display the current data for the user constant Cn-00.

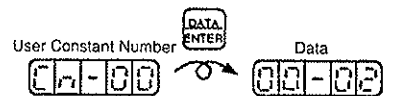

5) Press the and keys to change the data to 01.

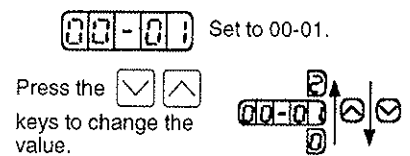

6) Press to automatically adjust the reference offset. The motor rotation stops.

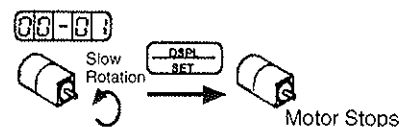

7) Press to return to the setting mode display. This ends reference offset automatic adjustment.

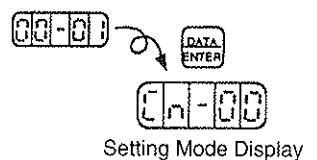



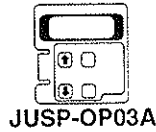

**For JUSP-OP03A**

1) Follow the procedure below to set the motor into operating mode.

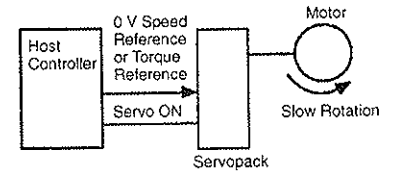

(1) Input the (intended) 0V reference voltage from the host controller or external circuit.

(2) Then, turn ON the servo ON (CN1-14,  $\overline{S-ON}$ ) signal.

2) Press  <sup>MODE/SET</sup> to select the user constant setting mode.

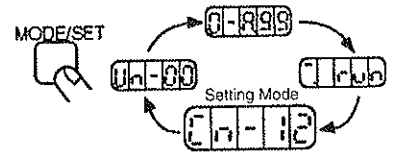

3) Press the  <sup>UP</sup> and  <sup>DOWN</sup> keys to select the user constant number Cn-00. (User constant Cn-00 is selected when the power is turned ON.)

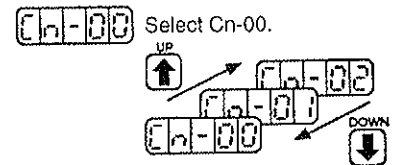

4) Press  <sup>DATA</sup> to display the current data for the user constant Cn-00.

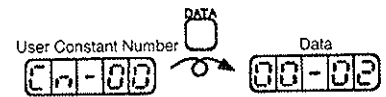

5) Press the  <sup>UP</sup> and  <sup>DOWN</sup> keys to change the data to 01.

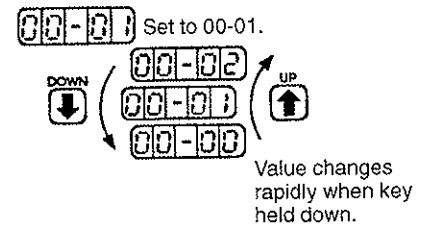

6) Press  <sup>MODE/SET</sup> to automatically adjust the reference offset. The motor rotation stops.

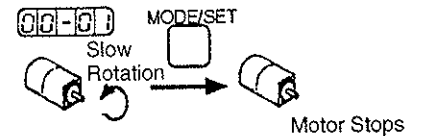

7) Press  <sup>DATA</sup> to return to the setting mode display. This ends reference offset automatic adjustment.

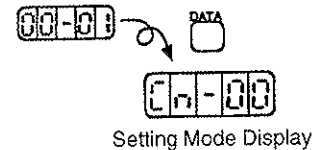

3

- 4) **The reference offset automatic adjustment mode cannot be used** where a position loop is formed with the host controller and the error pulses are zeroed when servo lock is stopped.

In this case, use the speed reference offset manual adjustment mode. Refer to sub-section 2.4.3 for details.

Zero-clamp speed control is available to force the motor to stop during zero speed reference. Refer to sub-section 2.4.3 for details.

### 3.2.8 Speed Reference Offset Manual Adjustment Mode

- 1) Speed reference offset manual adjustment is very convenient in the following situations:

- If a position loop is formed with the host controller and the error pulses are zeroed when servo lock is stopped.
- To deliberately set the offset to some value.

This mode can also be used to check the data set in the reference offset automatic adjustment mode.

In principle, this mode operates in the same way as the reference offset automatic adjustment mode, except that the amount of offset is directly input during the adjustment. The offset can be set for speed references only.

Offset Adjustment Range and Setting Units are as follows:

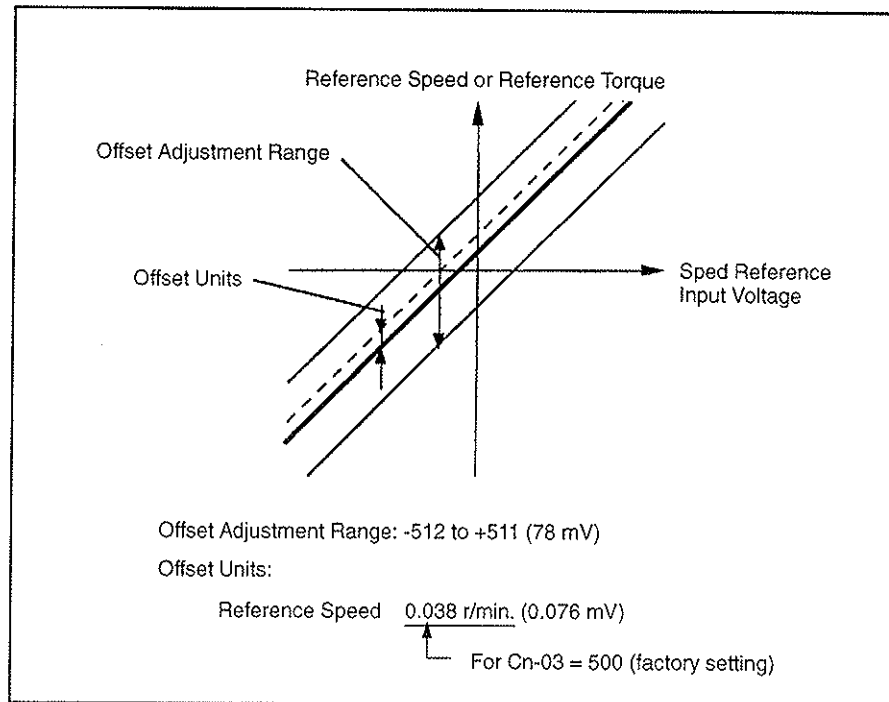

2) Follow the procedure below to manually adjust the reference voltage.

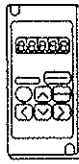

JUSP-OP02A-1

**For JUSP-OP02A-1**

1) Press to select the user constant setting mode.

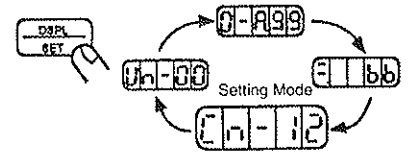

2) Select the user constant number Cn-00.  
(User constant Cn-00 is selected when the power is turned ON.)

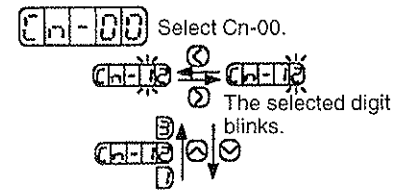

Press the and keys to select the digit.

Press and keys to change the value.

3) Press to display the current data for the user constant Cn-00.

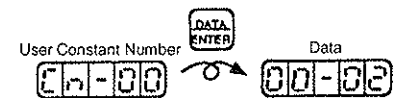

4) Press the and keys to change the data to 03.

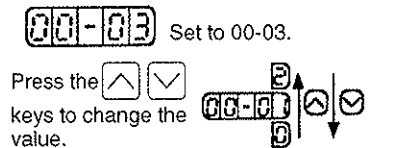

5) Press to select the speed reference offset manual adjustment mode.  
(The amount of speed reference offset is displayed.)

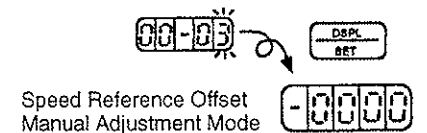

6) Press the and keys to adjust the amount of offset.  
(Adjust the speed references.)

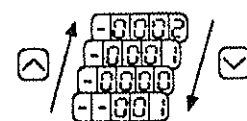

7) Press to return to the user constant data display.

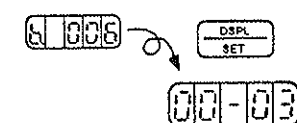

8) Press to return to the setting mode display. This ends the reference offset manual adjustment.

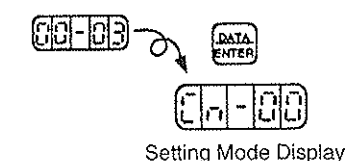



For JUSP-OP03A

1) Press <sup>MODE/SET</sup> to select the user constant setting mode.

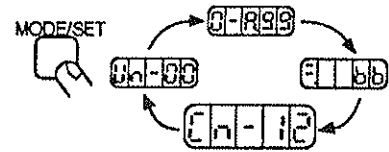

2) Press the <sup>UP</sup> and <sup>DOWN</sup> keys to select the user constant number Cn-00. (User constant Cn-00 is selected when the power is turned ON.)

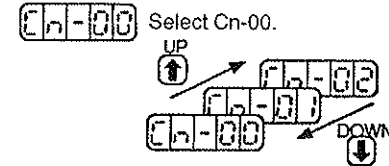

3) Press <sup>DATA</sup> to display the current data for the user constant Cn-00.

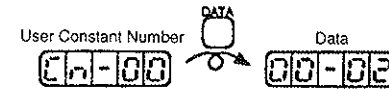

4) Press the <sup>UP</sup> and <sup>DOWN</sup> keys to change the data to 03.

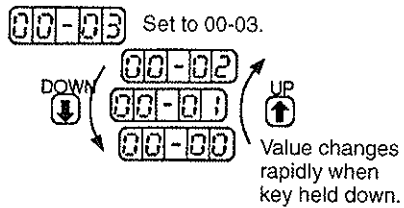

5) Press <sup>MODE/SET</sup> to select the speed reference offset manual adjustment mode. (The amount of speed reference offset is displayed.)

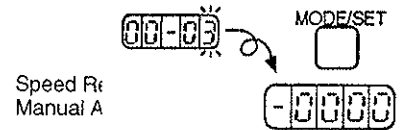

6) Press the <sup>UP</sup> and <sup>DOWN</sup> keys to adjust the amount of offset. (Adjust the speed references.)

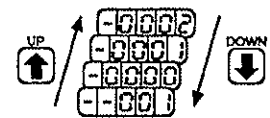

7) Press <sup>MODE/SET</sup> to return to the user constant data display.

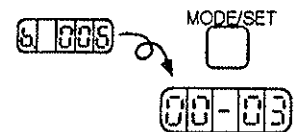

8) Press <sup>DATA</sup> to return to the setting mode display. This ends the reference offset manual adjustment.

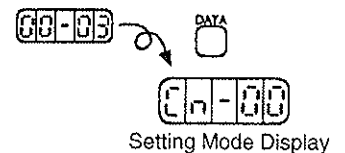

# SERVO SELECTION AND DATA SHEETS

---

# 4

This chapter describes how to select  $\Sigma$ -L Series servo drives and peripheral devices.

The section also presents the specifications and dimensional drawings required for selection and design.

Choose and carefully read the relevant sections of this chapter.

<b>4.1</b>	<b>Selecting a <math>\Sigma</math>-L Series Servo</b> .....	<b>131</b>
4.1.1	Selecting a Servomotor .....	131
4.1.2	Selecting a Servopack .....	142
4.1.3	Selecting a Digital Operator .....	144
<b>4.2</b>	<b>SGML Servomotor</b> .....	<b>145</b>
4.2.1	Ratings and Specifications .....	145
4.2.2	Mechanical Characteristics .....	154
<b>4.3</b>	<b>Servopack Ratings and Specifications</b> .....	<b>156</b>
4.3.1	Ratings and Specifications .....	156
4.3.2	Overload Characteristics .....	159
4.3.3	Starting Time and Stopping Time .....	160
4.3.4	Load Inertia .....	160
4.3.5	Overhanging Loads .....	162
4.3.6	Power Consumption .....	163
<b>4.4</b>	<b><math>\Sigma</math>-L Series Dimensional Drawings</b> .....	<b>164</b>
4.4.1	Servomotor Dimensional Drawings .....	164
4.4.2	Servopack Dimensional Drawings .....	178
4.4.3	Digital Operator Dimensional Drawings .....	181
<b>4.5</b>	<b>Selecting Peripheral Devices</b> .....	<b>182</b>
4.5.1	Selecting Peripheral Devices .....	182

<b>4.6</b>	<b>Specifications and Dimensional Drawings of Peripheral Devices .....</b>	<b>187</b>
4.6.1	Cable Specifications and Peripheral Devices .....	187
4.6.2	Motor Cables .....	190
4.6.3	Connector Kits .....	193
4.6.4	Brake Power Supply .....	197
4.6.5	Encoder Cables .....	199
4.6.6	CN1 Connector .....	203
4.6.7	Connector Terminal Block Converter Unit .....	205
4.6.8	Cable With CN1 Connector and One End Without Connector .....	207
4.6.9	Circuit Breaker .....	207
4.6.10	Noise Filter .....	208
4.6.11	Magnetic Contactor .....	209
4.6.12	Surge Suppressor .....	210
4.6.13	Regenerative Unit .....	211
4.6.14	Cables for Connecting PC and Servopack .....	213

## 4.1 Selecting a $\Sigma$ -L Series Servo

 This section describes how to select the  $\Sigma$ -L Series Servomotor, Servopack, and Digital Operator.

4.1.1	Selecting a Servomotor .....	131
4.1.2	Selecting a Servopack .....	142
4.1.3	Selecting a Digital Operator .....	144

### 4.1.1 Selecting a Servomotor

- 1) The selection of SGML Servomotor matched to the servo system in which it is used is based on the servomotor type, that is, the seven alphanumeric characters after "SGML-", described below. The numbers (1) to (6) below correspond to the numbers in the flow-chart for Servomotor selection on the following pages.

■ Model Numbers for Standard Servomotors

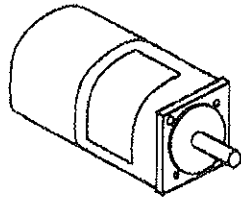

SGML type

SGML- 01 A F 1 2 □

- Σ-L Series  
SGML: SGML Servomotor
- 1) Rated output (motor capacity)
  - A3: 30W (0.04HP)    A5: 50W (0.07HP)
  - 01: 100W (0.13HP)    02: 200W (0.27HP)
  - 03: 300W (0.40HP)    04: 400W (0.53HP)
  - 08: 750W (1.01HP)
- 2) Supply voltage
  - A: 200V    B: 100V
- 3) Encoder specification
  - F: 1024 P/R incremental encoder
- 4) Design revision order
- 5) Shaft specification
  - 2: Straight without key
  - 3: Flat key seat
  - 4: Straight with key
- 6) Options
  - Blank: Standard (W/O brake)
  - B: With brake (90VDC)
  - C: With brake (24VDC)

Flowchart for Servomotor selection

	Selected motor type
Example	SGML - {0}{2}{B}{F}{1}{4}{B}
Axis 1	SGML - { } { } { } { } { } { } { }
Axis 2	SGML - { } { } { } { } { } { } { }
• • •	• • • • • • •





# SERVO SELECTION AND DATA SHEETS

## 4.1.1 Selecting a Servomotor cont.

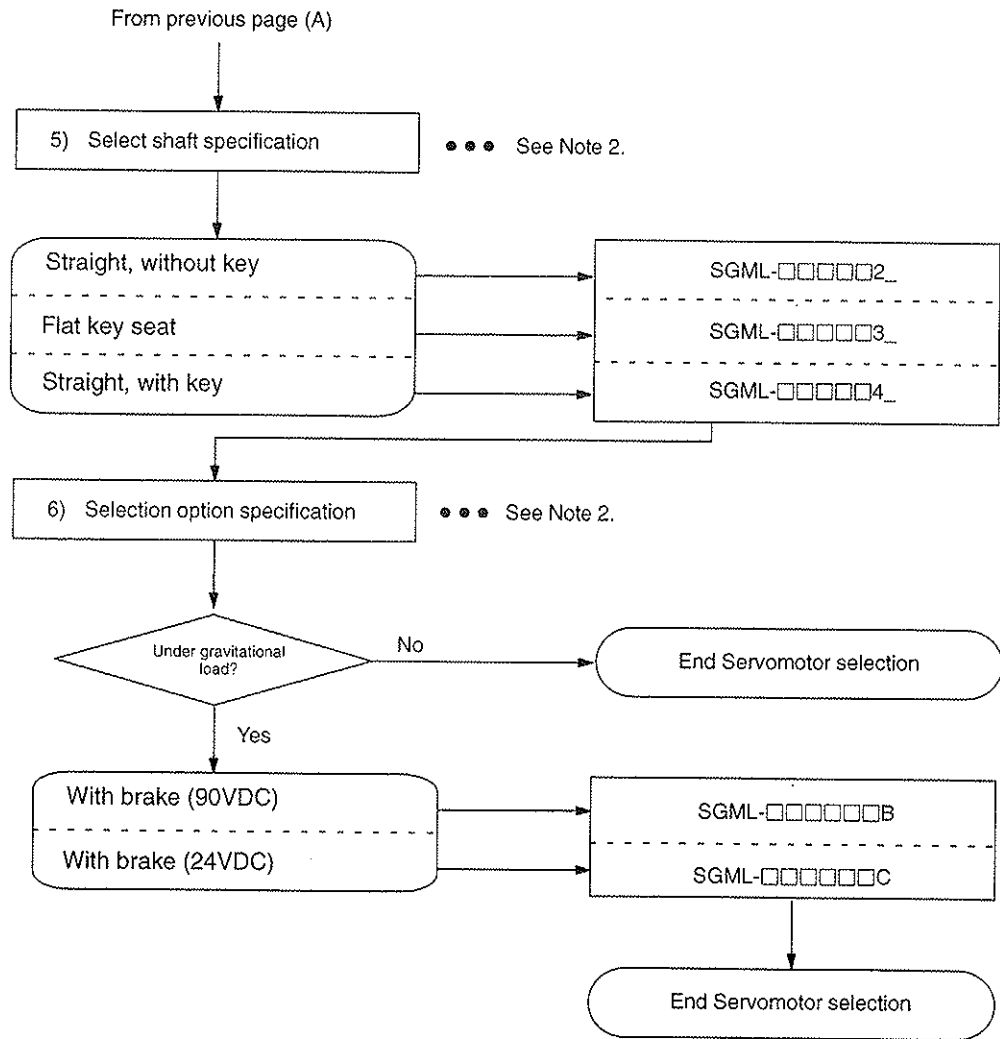

- Note**
- 1 Contact your Yaskawa representative for sizing or sizing software.
  - 2 Some options are not available according to the rated output. Confirm the options available by the Table on the next page.

	Power Supply		Shaft Specifications			Brake 90 VDC	Brake 24 VDC
	100V	200V	Straight, W/O Key	Flat Key Seat	Straight, W/ Key		
30W (0.04HP)	○	○	○	○	×	○	○
50W (0.07HP)	○	○	○	○	×	○	○
100W (0.13HP)	○	○	○	○	×	○	○
200W (0.27HP)	○	○	○	○	○	○	○
300W (0.40HP)	○	×	○	○	○	○	○
400W (0.53HP)	×	○	○	○	○	○	○
750W (1.01HP)	×	○	○	○	○	○	○

○: Available    ×: Not available

■ Model Numbers for Servomotors with Gears

SGML- 01 A F J 1 6 □

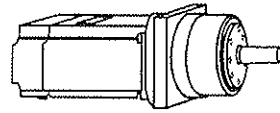

SGML type with gears

- Σ-L Series  
SGML: SGML Servomotor
- 1) Rated output (motor capacity)
  - A3: 30W (0.04HP)    A5: 50W (0.07HP)
  - 01: 100W (0.13HP)    02: 200W (0.27HP)
  - 03: 300W (0.40HP)    04: 400W (0.53HP)
  - 08: 750W (1.01HP)
- 2) Supply voltage
  - A: 200V    B: 100V
- 3) Encoder specification
  - F: 1024 P/R incremental encoder
- 4) Gear type
  - J: Standard backlash gear
- 5) Gear ratio
  - 1: 1/5    2: 3/31    3: 1/21    4: 1/33
- 6) Shaft end specification for standard backlash gears
  - 2: Straight
  - 6: Straight with key and tap
- 7) Options
  - Blank: Standard (W/O brake)
  - B: With brake (90VDC)
  - C: With brake (24VDC)

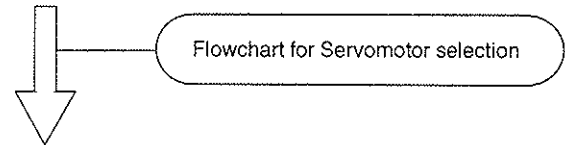

	Selected motor type
Example	SGML 01 A F J 1 6 □
Axis 1	SGML - □□□□□□□□□□
Axis 2	SGML - □□□□□□□□□□
• • •	• • • • • •

3) The actual selection of the SGML Servomotor with standard backlash gears is conducted according to the flowchart in the next page.

**Flowchart for Servomotor Selection**

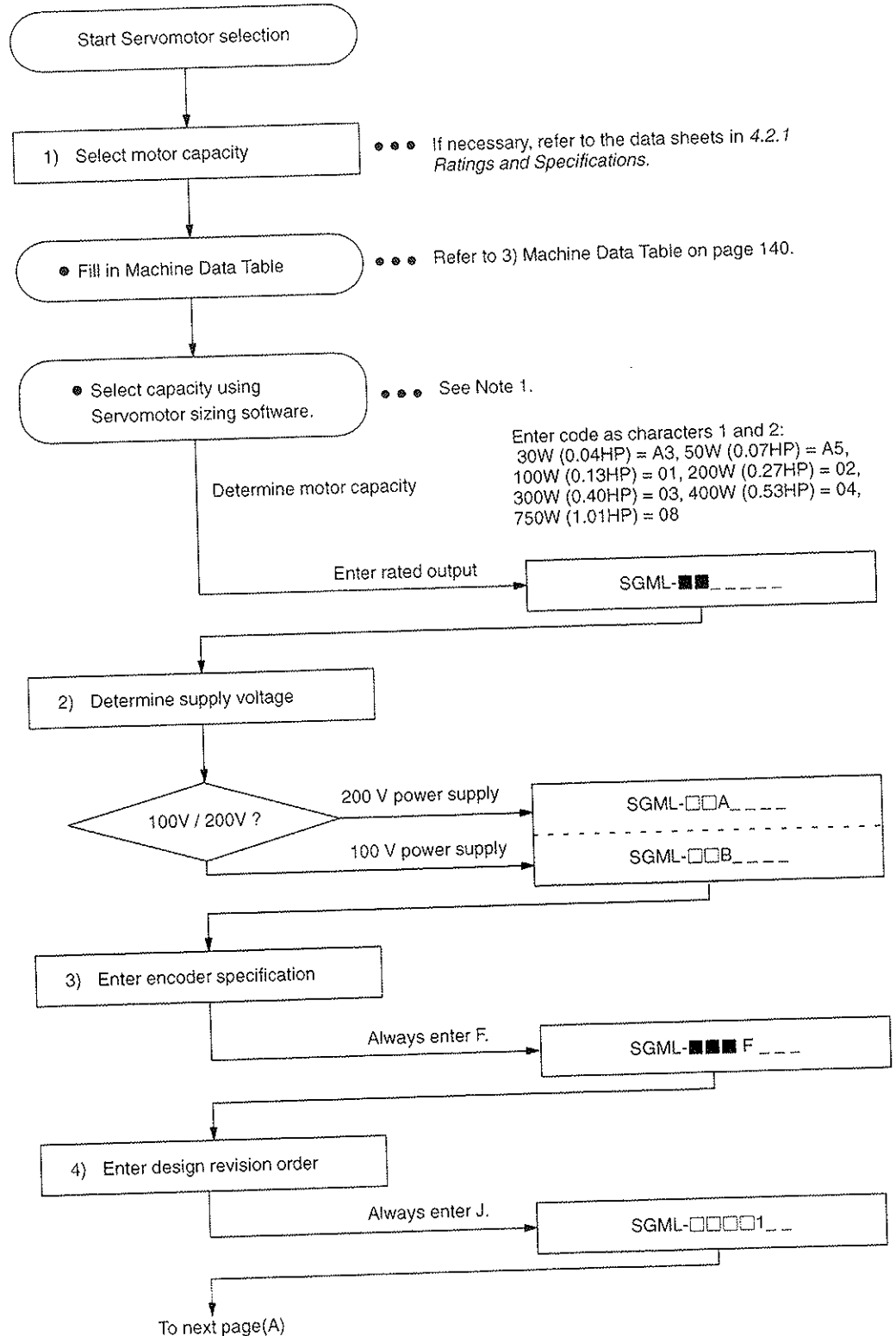

## SERVO SELECTION AND DATA SHEETS

### 4.1.1 Selecting a Servomotor cont.

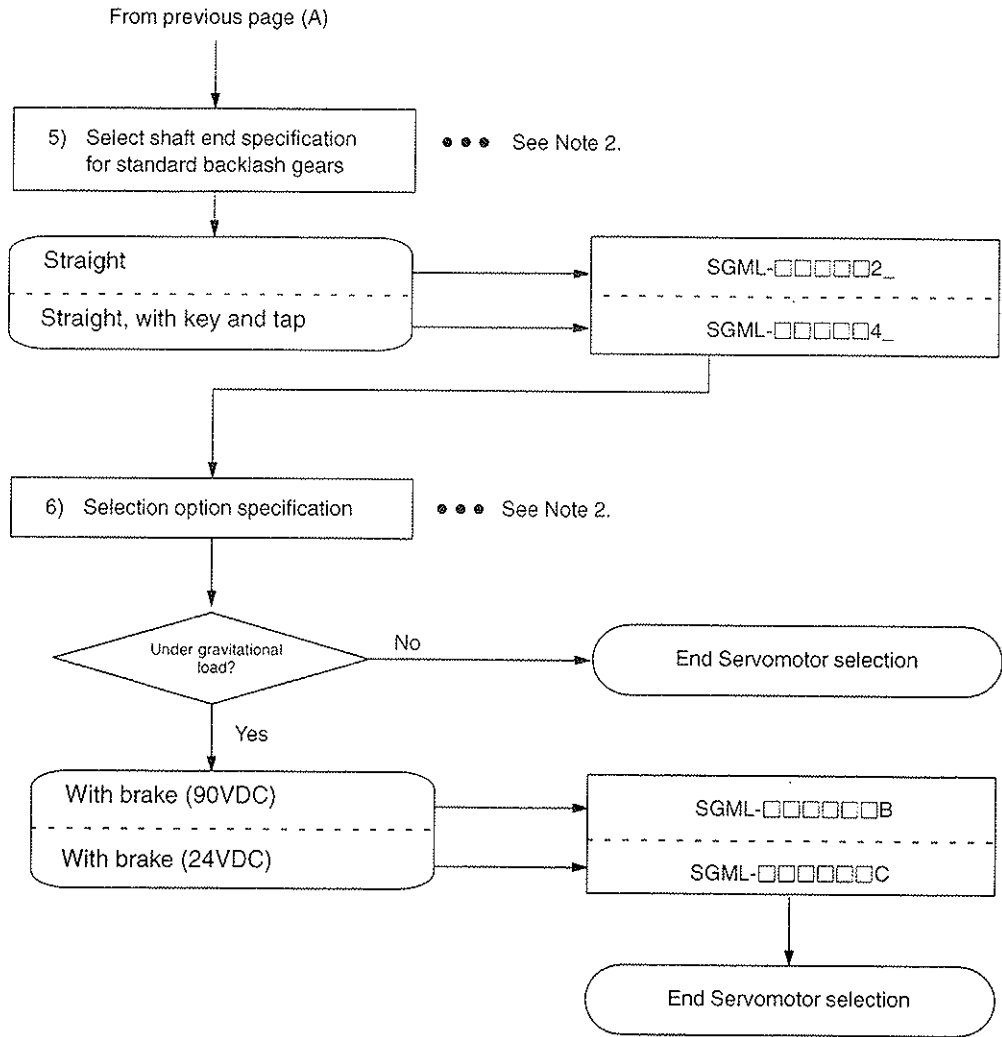

- Note**
- 1 Contact your Yaskawa representative for sizing or sizing software.
  - 2 Some options are not available according to the rated output. Confirm the options available by the Table on the next page.

	Power Supply		Shaft Specifications			Brake 90 VDC	Brake 24 VDC
	100V	200V	Straight, W/O Key	Flat Key Seat	Straight, W/ Key		
30W (0.04HP)	○	○	○	○	×	○	○
50W (0.07HP)	○	○	○	○	×	○	○
100W (0.13HP)	○	○	○	○	×	○	○
200W (0.27HP)	○	○	○	○	○	○	○
300W (0.40HP)	○	×	○	○	○	○	○
400W (0.53HP)	×	○	○	○	○	○	○
750W (1.01HP)	×	○	○	○	○	○	○

○: Available    ×: Not available

## SERVO SELECTION AND DATA SHEETS

### 4.1.1 Selecting a Servomotor cont.

#### 4) Machine Data Table

Fill out the machine data table below as an aid to selecting the drive system. When the machine data table is complete, use the servomotor sizing software to select the motor capacity.

1) Ball Screw Horizontal Axis			
Load mass	W	—kg (lb)	
Thrust	F	—kg (lb)	
Coefficient of friction	$\mu$	—	
Overall efficiency	$\eta$	—	
Gear ratio	R (= Nm/NI)	—	
Gear+coupling	GD <sup>2</sup> g	—kg·cm <sup>2</sup> (lb·in <sup>2</sup> .)	
Ball screw pitch	P	—mm (in.)	
Ball screw diameter	D	—mm (in.)	
Ball screw length	L	—mm (in.)	
2) Ball Screw Vertical Axis			
Load mass	W <sub>1</sub>	—kg (lb)	
Counterweight	W <sub>2</sub>	—kg (lb)	
Coefficient of friction	$\mu$	—	
Overall efficiency	$\eta$	—	
Gear ratio	R (= Nm/NI)	—	
Gear+coupling	GD <sup>2</sup> g	—kg·cm <sup>2</sup> (lb·in <sup>2</sup> .)	
Ball screw pitch	P	—mm (in.)	
Ball screw diameter	D	—mm (in.)	
Ball screw length	L	—mm (in.)	
3) Timing Belt			
Load mass	W	—kg (lb)	
Thrust	F	—kg (lb)	
Coefficient of friction	$\mu$	—	
Overall efficiency	$\eta$	—	
Gear ratio	R (= Nm/NI)	—	
Gear+coupling	GD <sup>2</sup> g	—kg·cm <sup>2</sup> (lb·in <sup>2</sup> .)	
Pulley	GD <sup>2</sup> d	—kg·cm <sup>2</sup> (lb·in <sup>2</sup> .)	
Pulley diameter	D	—mm (in.)	
4) Rack and Pinion			
Load mass	W	—kg (lb)	
Thrust	F	—kg (lb)	
Coefficient of friction	$\mu$	—	
Overall efficiency	$\eta$	—	
Gear ratio	R (= Nm/NI)	—	
Gear+coupling	GD <sup>2</sup> g	—kg·cm <sup>2</sup> (lb·in <sup>2</sup> .)	
Pinion diameter	D	—mm (in.)	
Pinion thickness	t	—mm (in.)	



5) Roll Feeder			
Load $GD^2$	$GD^2\ell$	—kg·cm <sup>2</sup> (lb·in <sup>2</sup> .)	
Tension	F	—kg (lb)	
Press force	P	—kg (lb)	
Roller diameter	D	—mm (in.)	
Coefficient of friction	$\mu$	—	
Overall efficiency	$\eta$	—	
Gear ratio	R (= Nm/NI)	—	
Gear+coupling	$GD^2g$	—kg·cm <sup>2</sup> (lb·in <sup>2</sup> .)	
6) Rotor			
Load $GD^2$	$GD^2\ell$	—kg·cm <sup>2</sup> (lb·in <sup>2</sup> .)	
Load torque	$T\ell$	—kg·cm <sup>2</sup> (lb·in <sup>2</sup> .)	
Overall efficiency	$\eta$	—	
Gear ratio	R (= Nm/NI)	—	
Gear+coupling	$GD^2g$	—kg·cm <sup>2</sup> (lb·in <sup>2</sup> .)	
7) Others			
Load $GD^2$	$GD^2\ell$	—kg·cm <sup>2</sup> (lb·in <sup>2</sup> .)	
Load torque	$T\ell$	—kg·cm <sup>2</sup> (lb·in <sup>2</sup> .)	
Motor speed	Nm	—r/min	
DUTY	td	—s	
Positioning time	ts	—s	
Accel/decel time	ta	—s	
• Duty cycle			
DUTY	td	—s	
Positioning distance	Ls	—mm (in.)	
Moving member speed	$V\ell$	—m/min	
Positioning time	ts	—s	
Accel/decel time	ta	—s	
Enter either $V\ell$ or $t_s$ . If both are entered, specify priority.			
• Operating environment			Operating temperature Others

### 4.1.2 Selecting a Servopack

1) The selection of an SGDL Servopack matched to the servo system in which it is used is based on the Servopack type, that is, the four alphanumeric characters after “SGDL-”, described below.

The numbers (1) to (3) below correspond to the numbers in the flowchart for Servopack selection on the following pages.

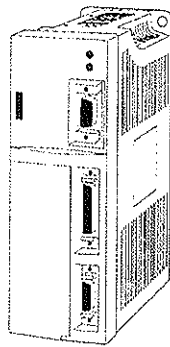

**SGDL- 01 A S**

Σ-L Series  
SGDL: SGDL Servopack

- 1) Rated output
  - A3: 30W (0.04HP) A5: 50W (0.07HP)
  - 01: 100W (0.13HP) 02: 200W (0.27HP)
  - 03: 300W (0.40HP) 04: 400W (0.53HP)
  - 08: 750W (1.01HP)
- 2) Supply voltage
  - A: 200V B: 100V
- 3) Model
  - S: For speed/torque control

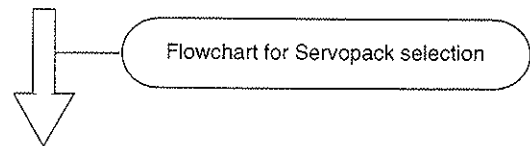

	Selected Servopack type
Example	SGDL -{0}{2}{B}{S}
Axis 1	SGDL -{ }{ }{ }{ }
Axis 2	SGDL -{ }{ }{ }{ }
• • •	• • • • •

2) The actual selection of the SGDL Servopack is conducted according to the following flowchart.

### Flowchart for Servopack Selection

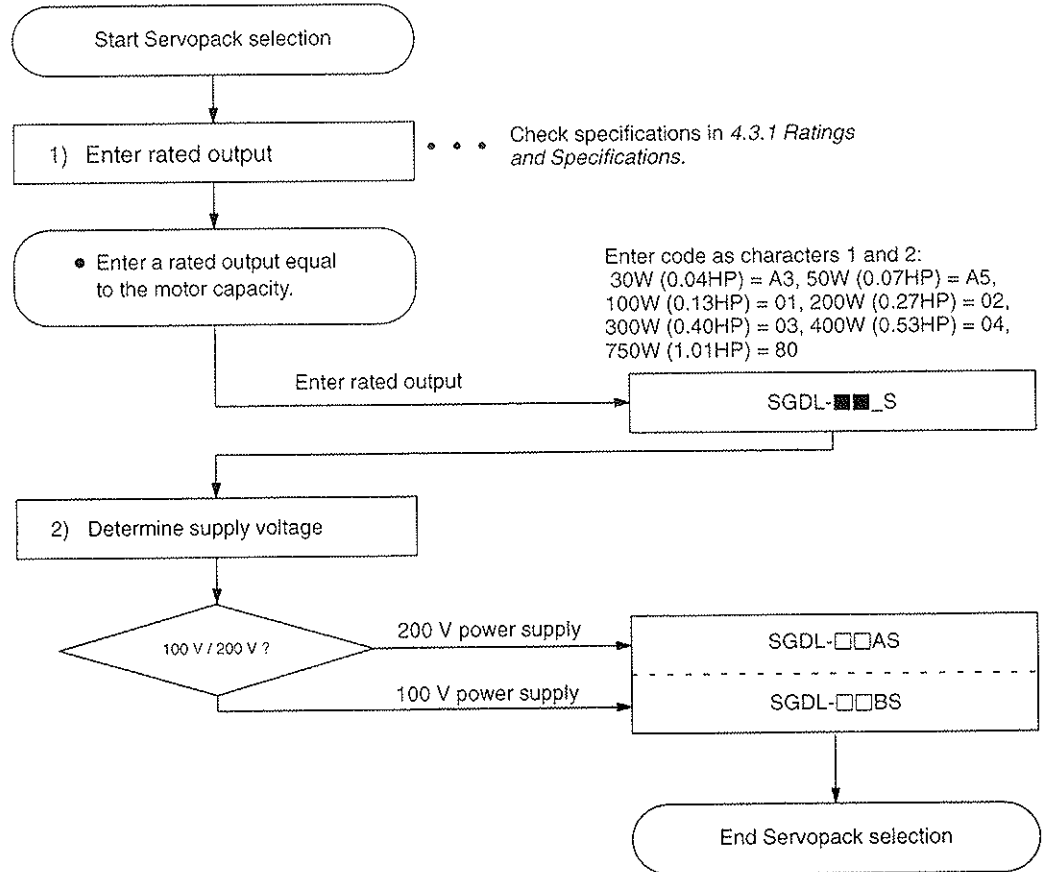

### 4.1.3 Selecting a Digital Operator

- The following two types of Digital Operator are available.  
The two types cannot be used simultaneously. However, it is convenient to prepare both types and use whichever suits the circumstances.  
Each type differs in shape but the operating functions are identical.

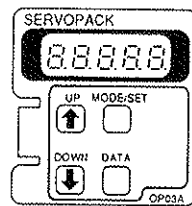

JUSP-OP03A (Mount Type)

- Use attached to the top of the Servopack front face.

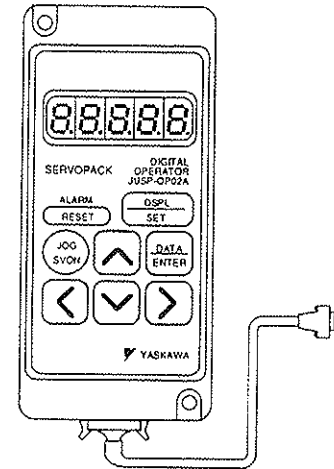

JUSP-OP02A-1 (Hand-held Type)

- Use held in the hand while connected with the 1 m cable supplied.

- The Digital Operator is selected according to the flowchart below.

#### Flowchart for Digital Operator Selection

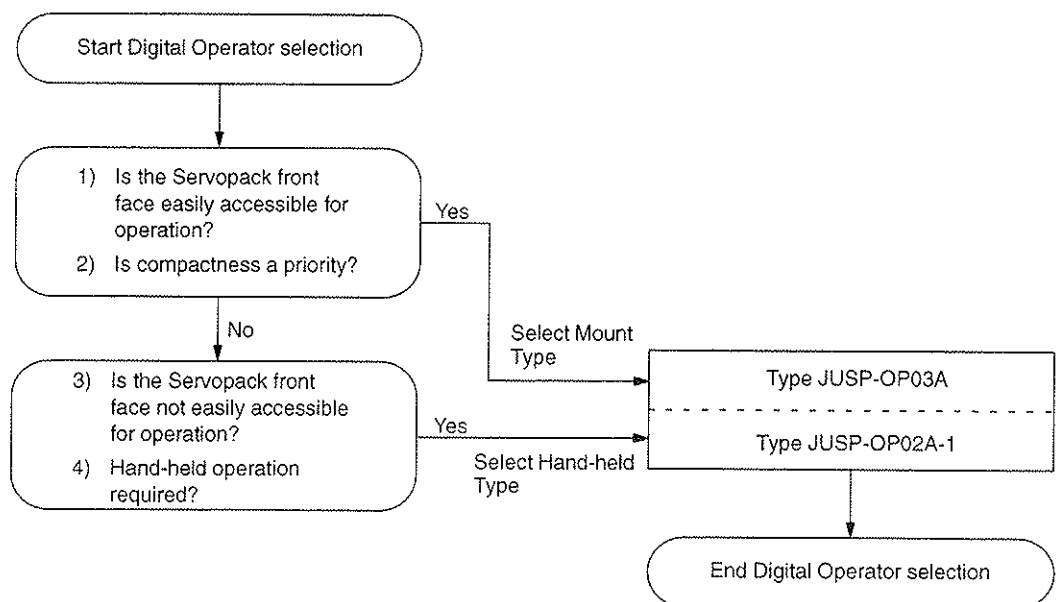

## 4.2 SGML Servomotor

This section presents tables of ratings and specifications for SGML Servomotor. Refer to these tables when selecting a Servomotor.

4.2.1	Ratings and Specifications .....	145
4.2.2	Mechanical Characteristics .....	154

### 4.2.1 Ratings and Specifications

#### 1) Ratings and Specifications of 200-VAC Standard SGML Servomotors

Time rating:	continuous
Heat resistance class:	Class B
Vibration class:	15 $\mu$ m or below
Withstand voltage:	1500 VAC
Insulation resistance:	500 VDC 10M $\Omega$ min.
Enclosure:	totally enclosed, self-cooled
Ambient temperature:	0 to 40°C
Ambient humidity:	20% to 80% (non-condensing)
Excitation:	permanent magnet
Drive method:	direct drive
Mounting:	flange method

SGML Servomotor		A3A	A5A	01A	02A	04A	08A
Rated Output* <sup>1</sup>	W (HP)	30 (0.04)	50 (0.07)	100 (0.13)	200 (0.27)	400 (0.53)	750 (1.01)
Rated Torque* <sup>1 *2</sup>	N.m	0.095	0.159	0.318	0.637	1.27	2.39
	(oz.in)	(13.5)	(22.6)	(45.1)	(90.1)	(181)	(338)
Instantaneous Peak Torque* <sup>1</sup>	N.m	0.29	0.48	0.96	1.91	3.82	7.1
	(oz.in)	(40.5)	(67.7)	(135)	(270)	(542)	(1010)
Rated Current* <sup>1</sup>	A (rms)	0.42	0.6	0.87	2.0	2.6	4.4
Instantaneous Max Current* <sup>1</sup>	A (rms)	1.3	1.9	2.8	6.0	8.0	13.9
Rated Speed* <sup>1</sup>	r/min	3000					
Instantaneous Max Speed* <sup>1</sup>	r/min	4500					
Torque Constant* <sup>1</sup>	N.m/A (rms)	0.255	0.286	0.408	0.355	0.533	0.590
	(oz.in/A) (rms)	(36.2)	(40.5)	(57.8)	(50.2)	(75.5)	(83.5)
Moment of Inertia [J <sub>M</sub> ]	kg.m <sup>2</sup> $\times 10^{-4}$	0.021	0.026	0.040	0.123	0.191	0.671
	(oz.in.s <sup>2</sup> $\times$ $10^{-3}$ )	(0.288)	(0.368)	(0.576)	(1.74)	(2.70)	(9.52)
Rated Power Rate* <sup>1</sup>	kW/s	4.36	9.63	25.4	32.8	84.6	85.1
Rated Angular Acceleration* <sup>1</sup>	rad/s <sup>2</sup>	45200	61200	79500	51800	666000	35600
Inertia Time Constant	ms	1.5	0.9	0.5	0.4	0.3	0.3
Inductive Time Constant	ms	1.5	1.8	1.9	5.4	6.4	13

## SERVO SELECTION AND DATA SHEETS

### 4.2.1 Ratings and Specifications cont.

\*1 These items and torque-motor speed characteristics quoted in combination with an SGDL Servopack at an armature winding temperature of 100°C. Other values quoted at 20°C. All values typical.

\*2 Rated torques are continuous allowable torque values at 40°C with a 250 x 250 x 6 (mm) (9.84 x 9.84 x 0.24 (in.)) heat sink attached.

**NOTE** The ratings and specifications above refer to a standard Servomotor.

Add the numerical values below to the moment of inertia values in the table for a motor fitted with a holding brake.

Other specifications will also change slightly.

Item	Type	SGML-					
		A3A	A5A	01A	02A	04A	08A
Holding brake	$\text{kg}\cdot\text{m}^2 \times 10^{-4}$	0.0085			0.058		0.14
	$(\text{oz}\cdot\text{in}\cdot\text{s}^2 \times 10^{-3})$	(0.120)			(0.816)		(1.98)

■ 200-VAC Standard SGML Servomotor Torque-Motor Speed Characteristics

• SGML-A3A

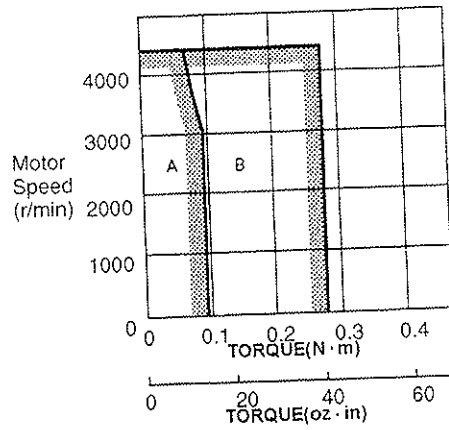

• SGML-A5A

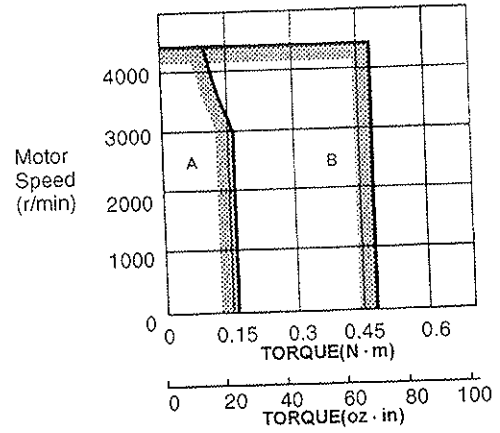

• SGML-01A

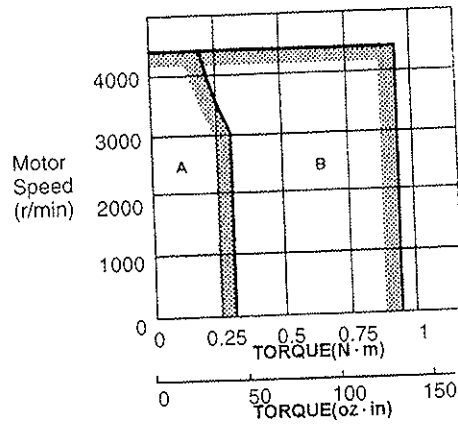

• SGML-02A

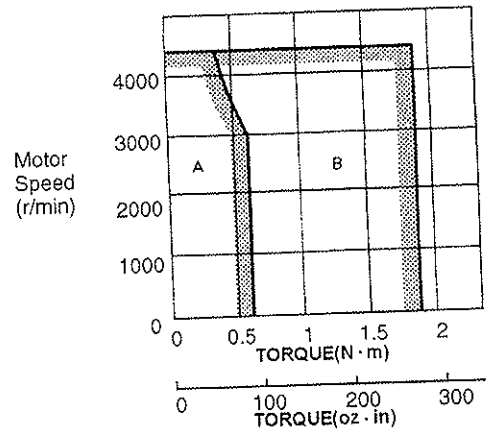

• SGML-04A

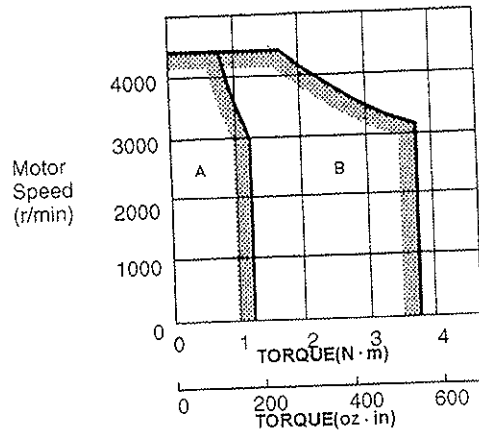

• SGML-08A

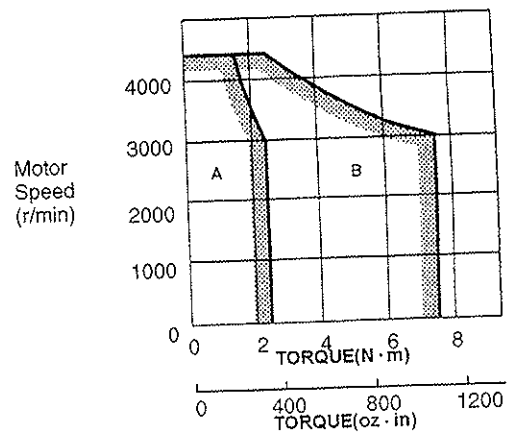

A: Continuous Duty Zone  
B: Intermittent Duty Zone

4

## SERVO SELECTION AND DATA SHEETS

### 4.2.1 Ratings and Specifications cont.

#### 2) Ratings and Specifications of 100-VAC Standard SGML Servomotors

Time rating:	continuous
Heat resistance class:	Class B
Vibration class:	15 $\mu$ m or below
Withstand voltage:	1500 VAC
Insulation resistance:	500 VDC 10M $\Omega$ min.
Enclosure:	totally enclosed, self-cooled
Ambient temperature:	0 to 40°C
Ambient humidity:	20% to 80% (non-condensing)
Excitation:	permanent magnet
Drive method:	direct drive
Mounting:	flange method

SGML Servomotor		A3B	A5B	01B	02B	03B
Rated Output *1	W (HP)	30 (0.04)	50 (0.07)	100 (0.13)	200 (0.27)	300 (0.40)
Rated Torque *1 *2	N.m	0.095	0.159	0.318	0.637	0.95
	(oz.in)	(13.5)	(22.6)	(45.1)	(90.1)	(135.0)
Instantaneous Peak Torque *1	N.m	0.29	0.48	0.96	1.91	3.72
	(oz.in)	(40.5)	(67.7)	(135)	(270)	(527.7)
Rated Current *1	A (rms)	0.63	0.9	2.2	2.7	3.7
Instantaneous Peak Current *1	A (rms)	2.0	2.9	7.1	8.4	14.8
Rated Rotation Speed *1	r/min	3000				
Max. Rotation Speed *1	r/min	4500				
Torque Constant *1	N.m/A (rms)	0.168	0.194	0.156	0.255	0.279
	oz.in/A (rms)	(23.8)	(27.5)	(22.1)	(36.1)	(39.6)
Moment of Inertia	(=GD <sup>2</sup> /4) kg.m <sup>2</sup>	0.021 $\times 10^{-4}$	0.026 $\times 10^{-4}$	0.040 $\times 10^{-4}$	0.123 $\times 10^{-4}$	0.191 $\times 10^{-4}$
	(oz.in.s <sup>2</sup> $\times 10^{-3}$ )	(0.288)	(0.368)	(0.576)	(1.74)	(2.71)
Rated Power Rating *1	kW/S	4.36	9.63	25.4	32.8	47.3
Rated Angular Acceleration *1	rad/s <sup>2</sup>	45200	61200	79500	51800	49700
Inertia Time Constant	ms	1.6	0.9	0.6	0.4	0.3
Inductive Time Constant	ms	1.3	1.6	1.6	5.7	5.3

\*1 These items and torque-motor speed characteristics quoted in combination with an SGDL Servopack at an armature winding temperature of 100°C. Other values quoted at 20°C. All values typical.

\*2 Rated torques are continuous allowable torque values at 40°C with a 250 x 250 x 6 (mm) (9.84 x 9.84 x 0.24 (in.)) heat sink attached.



**NOTE** The ratings and specifications above refer to a standard Servomotor.

Add the numerical values below to the moment of inertia values in the table for a motor fitted with a holding brake.

Other specifications will also change slightly.

Item	Type	SGML-				
		A3B	A5B	01B	02B	03B
Holding brake	$\text{kg}\cdot\text{m}^2 \times 10^{-4}$	0.0085			0.058	
	$(\text{oz}\cdot\text{in}\cdot\text{s}^2 \times 10^{-3})$	0.12			0.82	

■ 100-VAC Standard SGML Servomotor Torque-Motor Speed Characteristics

• SGML-A3B

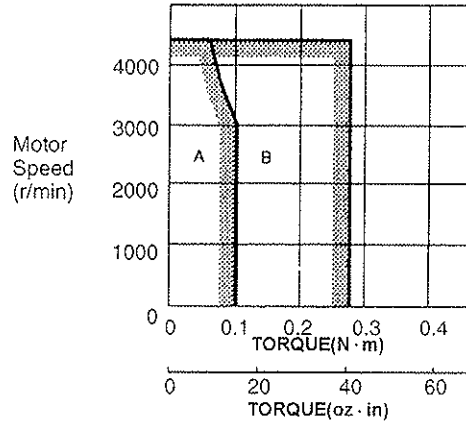

• SGML-A5B

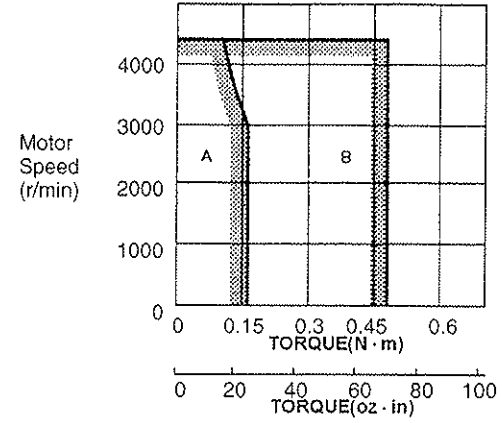

• SGML-01B

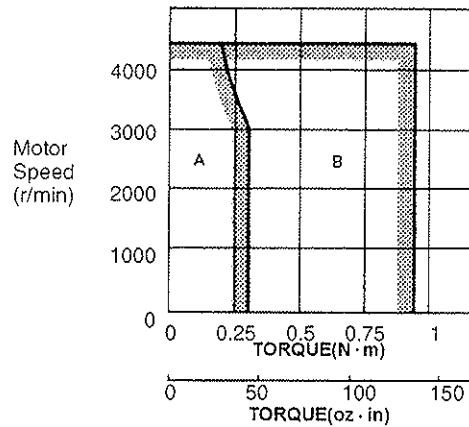

• SGML-02B

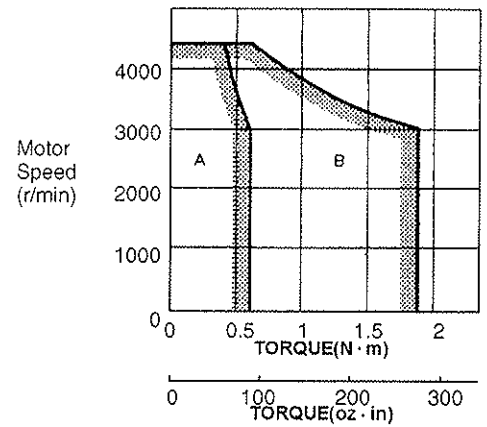

• SGML-03B

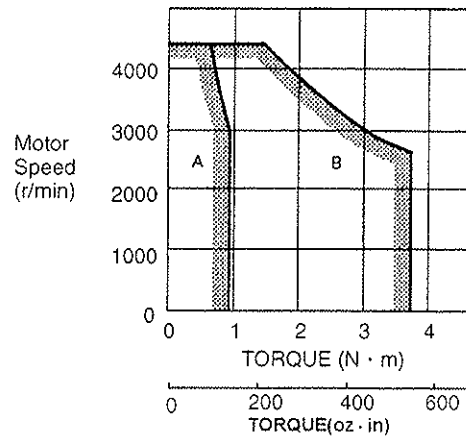

A: Continuous Duty Zone  
B: Intermittent Duty Zone

## 3) Specifications of SGML Servomotors with Holding Brake

Ratings and specifications of Servomotors with **holding brake** are basically the same as those of standard (without holding brake) Servomotors shown in 1) and 2). However, the moment of inertia is as shown below. Other specifications will also change slightly.

Item \ Type		SGML-										
		A3A	A5A	01A	02A	04A	08A	A3B	A5B	01B	02B	03B
Moment of Inertia (W/ brake)	kg·m × 10 <sup>-4</sup>	0.0295	0.0345	0.0485	0.181	0.249	0.811	0.0295	0.0345	0.0485	0.181	0.372
	oz·in·s <sup>2</sup> × 10 <sup>-3</sup>	0.408	0.488	0.696	2.556	3.516	11.5	0.408	0.488	0.696	2.556	3.53

## Electrical Specifications of the Holding Brake

Motor Type	Motor Capacity (W)	Holding Brake Specifications					
		Capacity (W)	Holding Torque (Kg-cm)	90VDC		24VDC	
				Coil Resistance $\Omega$ (at 20°C)	Rated Current A (at 20°C)	Coil Resistance $\Omega$ (at 20°C)	Rated Current A (at 20°C)
SGML-A3□□□□	30	6	2.0	1350	0.067	96	0.25
SGML-A5□□□□	50	6	2.0	1350	0.067	96	0.25
SGML-01□□□□	100	6	3.5	1350	0.067	96	0.25
SGML-02□□□□	200	6.5	15	1246	0.072	89	0.27
SGML-03□□□□	300	6.5	15	1246	0.072	89	0.27
SGML-04□□□□	400	6.5	15	1246	0.072	89	0.27
SGML-08□□□□	750	6	25	1350	0.067	96	0.025



## Holding Brake

The holding brake is automatically applied to the motor shaft to prevent the load falling in vertical axis applications when the motor power supply is turned off or fails. It is only to hold the load and cannot be used for stopping motor.

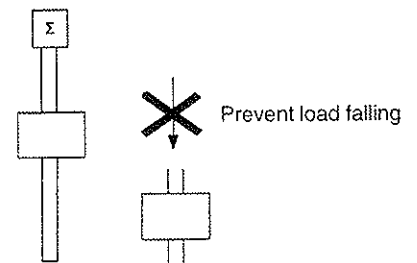

## SERVO SELECTION AND DATA SHEETS

### 4.2.1 Ratings and Specifications cont.

#### 4) Ratings and Specifications of 200-VAC SGML Servomotors with Standard Backlash Gears

Time rating:	continuous
Heat resistance class:	Class B
Vibration class:	15µm or below
Withstand voltage:	1500 VAC for one minute
Insulation resistance:	500 VDC 10MΩ min.
Enclosure:	totally enclosed, self-cooled
Ambient temperature:	0 to 40°C
Ambient humidity:	20% to 80% (non-condensing)
Excitation:	permanent magnet
Drive method:	direct drive
Mounting:	flange method
Backlash:	15 to 20 min max.
Gear mechanism:	planetary gear mechanism

Motor Type SGML-	Motor			Gear							Moment of Inertia (= GD <sup>2</sup> /4) kg·m <sup>2</sup> × 10 <sup>-4</sup> (lb·in·s <sup>2</sup> × 10 <sup>-9</sup> )	Applicable SERVOPACK
	Rated Output W(HP)	Rated Torque N·m (lb·in)	Rated Rotation Speed (r/min)	Type	Gear Ratio	Lost Motion	Rated Torque N·m (lb·in)	Rated Speed (r/min)	Allowable Radial Load Fr (lb)	Allowable Radial Load Fs (lb)		
A3□FJ1□	30 (0.04)	0.095 (0.841)	3000	CP-14	1/5	20	0.24 (2.12)	600	145 (32.6)	125 (28.1)	0.049 (0.043)	SGDE-A3□□
A3□FJ2□					3/31		0.69 (6.11)	290	185 (41.6)		0.037 (0.033)	
A3□FJ3□					1/21		1.6 (14.2)	143			0.028 (0.025)	
A3□FJ4□					1/33		2.51 (22.2)	91	0.026 (0.023)			
A5□FJ1□	50 (0.07)	0.159 (1.41)		CP-14	1/5	20	0.56 (4.96)	600	145 (32.6)	125 (28.1)	0.054 (0.048)	SGDE-A5□□
A5□FJ2□				3/31	1.15 (10.2)		290	215 (48.4)	145 (32.6)	0.044 (0.039)		
A5□FJ3□				1/21	2.67 (23.6)		143	230 (51.8)		0.040 (0.035)		
A5□FJ4□				1/33	4.2 (37.2)		91	245 (55.1)	0.036 (0.032)			
01□FJ1□	100 (0.13)	0.318 (2.81)		CP-16	1/5	15	1.27 (11.2)	600	175 (39.4)	145 (32.6)	0.103 (0.091)	SGDE-01□□
01□FJ2□				3/31	2.63 (23.3)		290	215 (48.4)	0.058 (0.051)			
01□FJ3□				1/21	5.34 (47.3)		143	455 (102)	235 (52.9)	0.075 (0.066)		
01□FJ4□				1/33	8.4 (74.3)		91	480 (108)		0.061 (0.054)		
02□FJ1□	200 (0.27)	0.637 (5.64)		CP-20	1/5	15	2.55 (22.6)	600	275 (61.9)	235 (52.9)	0.316 (0.280)	SGDE-02□□
02□FJ2□				3/31	5.27 (46.6)		290	360 (81.0)	0.213 (0.189)			
02□FJ3□				1/21	10.7 (94.7)		143	585 (132)	290 (65.3)	0.228 (0.202)		
02□FJ4□				1/33	16.8 (149)		91	635 (143)		0.198 (0.175)		
03BFJ1□	300 (0.40)	0.955 (8.45)	CP-20	1/5	15	3.82 (33.8)	600	275 (61.9)	235 (52.9)	0.384 (0.340)	SGDE-03B□	
03BFJ2□			CP-25	3/31		7.89 (69.8)	290	460 (104)		290 (65.3)		0.371 (0.328)
03BFJ3□			1/21	16 (142)		143	655 (147)	310 (69.8)	0.421 (0.373)			
03BFJ4□			1/33	25.2 (223)		91	755 (170)		0.356 (0.315)			
04AFJ1□	400 (0.53)	1.27 (11.2)	CP-20	1/5	15	5.08 (45.0)	600	275 (61.9)	235 (52.9)	0.384 (0.340)	SGDE-04A□	
04AFJ2□			CP-25	3/31		10.5 (92.9)	290	460 (104)		290 (65.3)		0.371 (0.328)
04AFJ3□			1/21	21.3 (189)		143	655 (147)	310 (69.8)	0.421 (0.373)			
04AFJ4□			1/33	33.5 (296)		91	755 (170)		0.356 (0.315)			
08AFJ1□	750 (1.01)	2.39 (21.2)	CP-25	1/5	15	9.56 (84.6)	600	355 (79.9)	290 (65.3)	1.12 (0.991)	SGDE-08A□	
08AFJ2□			CP-32	3/31		19.8 (175)	290	525 (118)		310 (69.8)		1.10 (0.974)
08AFJ3□			1/21	40.2 (356)		143	1070 (241)	490 (110)	1.15 (1.02)			
08AFJ4□			1/33	63.1 (558)		91	1205 (271)		0.971 (0.859)			

\*1 Maximum motor speed is up to 4000 (r/min) at the shaft.

\*2 Gear output torque is expressed using by the following equation.  
 (Gear output torque) = (Servomotor output torque) × (gear ratio) × (efficiency)  
 The instantaneous peak torque values indicated with \*2 are limited by the gear, so use the following Servomotor instantaneous peak torque. In this case, set torque limit user constants Pn402 and 403 for the Servopack at 250 %.

**NOTE** Output torque and motor speed produce the following trends in efficiency. Values in the table are at the rated motor torque and rated motor speed (3000 r/min).

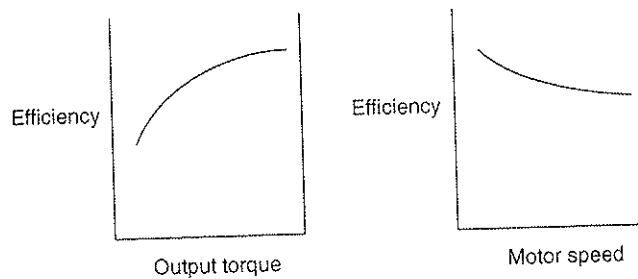

Item	Measurement Method/Definition	Typical Value
Rated Input Motor Speed	-	3000 (r/min)
Max. Allowable Input Motor Speed	-	4000 (r/min)
Rated Torque	The rated output torque of the motor is the gear input torque. The rated torque is this value multiplied by the gear ratio and efficiency.	
Lost Motion *	Angular difference in the screw with a ±5% rated torque load. (Maximum value at any four positions during output.)	3 (arc-min) max.
Torsion Rigidity *	Highest torsion angle value on one side with a ± rated torque load.	10 (arc-min) max.
Angular Transmission Error Accuracy	Difference in absolute accuracy for one rotation under load and no-load conditions during output.	6 (arc-min) max.

\* See the figure below for lost motion and torsion rigidity.

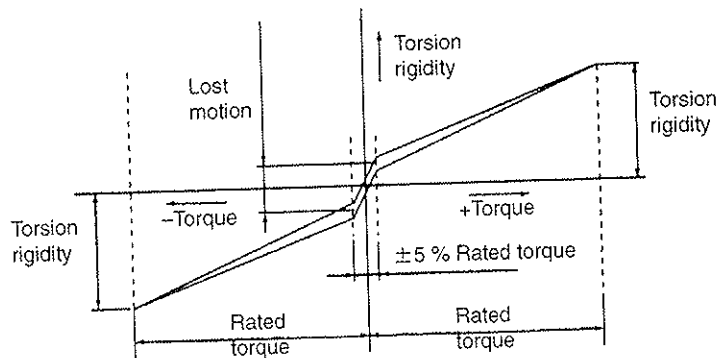

4

### 4.2.2 Mechanical Characteristics

The tables below show the SGML Servomotor mechanical characteristics other than the ones with standard backlash gears.

1) Allowable Radial Load, Allowable Thrust Load

The output shaft allowable loads for SGML Servomotor are shown below.

Conduct mechanical design such that the thrust loads and radial loads do not exceed the values stated below.

Servomotor Type	Allowable Radial Load Fr [N(lb)]	Allowable Thrust Load Fs [N(lb)]	Reference Diagram
SGML-A3	68 (15)	54 (12)	
SGML-A5	68 (15)	54 (12)	
SGML-01	78 (17)	54 (12)	
SGML-02	245 (55)	74 (16)	
SGML-03	245 (55)	74 (16)	
SGML-04	245 (55)	74 (16)	
SGML-08	392 (88)	147 (33)	

2) Mechanical Tolerance

The tolerances of the SGML Servomotor output shaft and installation are shown in the table below.

Tolerance (T.I.R.)	Reference Diagram
Perpendicularity between flange face and output shaft (A) 0.08mm (0.0031in.)	
Mating concentricity of flange O.D. (B) 0.06mm (0.0024in.)	
Run-out at end of shaft (C) 0.03mm (0.0012in.)	

**Note** T.I.R. = Total Indicator Reading

3) Direction of Motor Rotation

Positive rotation of the servomotor is counter-clockwise, viewing from the load.

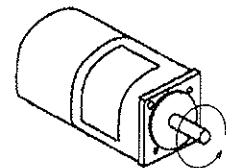

## 4) Impact Resistance

Mount the servomotor with the axis horizontal. The servomotor must withstand the following vertical impacts.

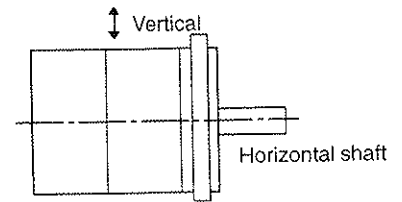

- Impact Acceleration:  $98 \text{ m/s}^2$  (10 G)
- Number of Impacts: 2

**NOTE** In SGML Servomotor, an accurate detector is attached to the shaft at the opposite end from the load. Avoid applying impacts directly to the shaft as these may damage the detector.

## 5) Vibration Resistance

Mount the servomotor with the axis horizontal. The servomotor must withstand the following vibration accelerations in three directions: vertical, transverse, and longitudinal.

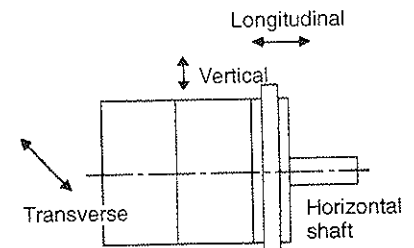

- Vibration Acceleration:  $24.5 \text{ m/s}^2$  (2.5 G)

## 6) Vibration Class

The SGML Servomotor meets the following **vibration class** at rated speed.

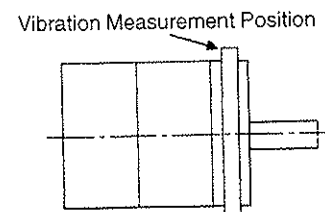

- Vibration Class:  $15\mu\text{m}$  or below

**Vibration Class**

Vibration class  $15\mu\text{m}$  or below indicates that the total amplitude of vibration of the motor alone, running at rated speed, does not exceed  $15\mu\text{m}$ .

### 4.3 Servopack Ratings and Specifications

☒ This section presents tables of SGDL Servopack ratings and specifications.

4.3.1	Ratings and Specifications .....	156
4.3.2	Overload Characteristics .....	159
4.3.3	Starting Time and Stopping Time .....	160
4.3.4	Load Inertia .....	160
4.3.5	Overhanging Loads .....	162
4.3.6	Power Consumption .....	163

#### 4.3.1 Ratings and Specifications

1) The ratings and specifications of the SGDL Servopack are shown on the next page. Refer to them as required when selecting a Servopack. Refer to the specifications listed for combination with the appropriate type of Servomotor.

2) Ratings and Specifications of SGDL Servopack

Voltage			200 VAC					100 VAC					
SGDL Servopack			A3AS	A5AS	01AS	02AS	04AS	08AS	A3BS	A5BS	01BS	02BS	03BS
Max. Applicable Motor Capacity W (HP)			30 (0.04)	50 (0.07)	100 (0.13)	200 (0.27)	400 (0.53)	750 (1.01)	30 (0.04)	50 (0.07)	100 (0.13)	200 (0.27)	300 (0.40)
Combined Specifica- tions	Motor	Type SGML-	A3AF	A5AF	01AF	02AF	04AF	08AF	A3BF	A5BF	01BF	02BF	03BF
		Motor Capacity W (HP)	30 (0.04)	50 (0.07)	100 (0.13)	200 (0.27)	400 (0.53)	750 (1.01)	30 (0.04)	50 (0.07)	100 (0.13)	200 (0.27)	300 (0.40)
		Rated/Max. Motor Speed	3000/4500 r/min					3000/4500 r/min					
		Applicable encoder	Incremental encoder 1024 P/R										
Combined Specifica- tions		Allowable Load Iner- tia*1 J <sub>L</sub> kg·m <sup>2</sup> × 10 <sup>-4</sup> (oz·in·s <sup>2</sup> × 10 <sup>-3</sup> )	0.63 (8.80)	0.78 (11.0)	1.20 (17.0)	3.69 (52.2)	3.82 (54.1)	13.4 (189)	0.63 (8.80)	0.78 (11.0)	1.20 (17.0)	3.69 (52.2)	3.82 (54.1)
Combined Specifica- tions	Continuous Output Current		0.42	0.6	0.87	2.0	2.6	4.4	0.63	0.90	2.2	2.7	3.7
	Max. Output Current		1.3	1.9	2.8	6.0	8.0	13.9	2.0	2.9	7.1	8.4	14.8



Voltage			200 VAC					100 VAC					
SGDL Servopack			A3AS	A5AS	01AS	02AS	04AS	08AS	A3BS	A5BS	01BS	02BS	03BS
Max. Applicable Motor Capacity W (HP)			30 (0.04)	50 (0.07)	100 (0.13)	200 (0.27)	400 (0.53)	750 (1.01)	30 (0.04)	50 (0.07)	100 (0.13)	200 (0.27)	300 (0.40)
Basic Specifica- tions	Power Supply		Single-phase 200 to 230 VAC, +10% to -15%, 50/60 Hz					Single-phase 100 to 115 VAC*2, +10% to -15%, 50/60 Hz					
	Control Method		Single-phase, full-wave rectification IGBT-PWM (sine-wave driven)										
	Feedback		Incremental encoder 1024 P/R										
	Location	Ambient Temp.	0 to 50°C*3										
		Storage Temp.	-20 to +85°C										
		Ambient/ Storage Humidity	90% or less (with no condensation)										
		Vibration/ Shock Resistance	4.9m/s <sup>2</sup> / 19.6m/s <sup>2</sup> (0.5/2G)										
	Structure		Base mounted										
	Approx. mass kg (lb)		0.9 (1.98)					1.2 (2.65)	1.5 (3.31)	0.9 (1.98)		1.2 (2.65)	1.5 (3.31)
Perfor- mance	Speed Control Range*4		1:5000										
	Speed Regula- tion*5	Load Regulation	0% to 100%:0.01% max. (at rated speed)										
		Voltage Regulation	0%										
		Temperature Regulation	25±25°C: ±0.1% max. (at rated speed)										
	Frequency Characteristics		200 Hz (at $J_L=J_M$ )										
	Torque Control (Repeatability)		±2.0%										
	Accel/Decel Time Setting		0 to 10 s										
Input Signal	Speed Refer- ence	Rated Reference Voltage	±6 VDC (positive motor rotation with positive reference) at rated speed (factory setting) Variable setting range: ±2 to ±10 VDC at rated torque										
		Input Impedance	Approx. 30 kΩ										
		Circuit Time Constant	Approx. 47 μs										
	Torque Refer- ence	Rated Reference Voltage	±3 VDC (positive motor rotation with positive reference) at rated speed (factory setting) Variable setting range: ±1 to ±10 VDC at rated torque										
		Input Impedance	Approx. 30 kΩ										
		Circuit Time Constant	Approx. 47 μs										

## SERVO SELECTION AND DATA SHEETS

### 4.3.1 Ratings and Specifications cont.

Voltage			200 VAC				100 VAC						
SGDL Servopack			A3AS	A5AS	01AS	02AS	04AS	08AS	A3BS	A5BS	01BS	02BS	03BS
Max.Applicable Motor Capacity W (HP)			30 (0.04)	50 (0.07)	100 (0.13)	200 (0.27)	400 (0.53)	750 (1.01)	30 (0.04)	50 (0.07)	100 (0.13)	200 (0.27)	300 (0.40)
I/O Signals	Position Output	Output Form	A-, B-, C-phase line driver										
		Frequency Dividing Ratio	(16 to N) /N N=1024* <sup>6</sup>										
	Sequence Input	Servo ON, P drive (or motor forward/reverse by torque control, zero-clamp drive reference, or internal setting speed), forward run stop (P-OT), reverse run stop (N-OT), current limit + selection (or internal speed selection), current limit – selection (or internal speed selection), alarm reset											
	Sequence Output	Current limit detection (or TGON), external brake interlock, servo alarm, 3-bit alarm codes											
Dynamic Brake			Operated at main power OFF, servo alarm or overtravel.										
External Regenerative Unit			Required when exceeding the allowable load inertia* <sup>1</sup>										
Overtravel			Dynamic brake stop at P-OT or N-OT										
Protective Functions			Overcurrent, grounding, overload, overvoltage, overspeed, reference input read error, overrun prevention, CPU error, encoder error										
Indicators			Alarm and power LEDs										
			Programming panel is available as an option										
Others			Torque control, zero clamp operation (position loop stop), soft start/stop, brake interlock signal output, reverse run connection, JOG run, auto-tuning										

\*1 Allowable load inertia ranges require no optional external regenerative unit. Values are 30 times the moment of inertia for 30 W (0.04 HP) to 200 W (0.27 HP) Servomotors, and 20 times for 400 W (0.53 HP) and 750 W (1.01 HP) Servomotors. If load inertias exceed these ranges, restrict the operation or use a regenerative unit.

\*2 Supply voltage should not exceed 230 V + 10% (253 V) or 115 V + 10% (127 V). A step-down transformer is required if the voltage should exceed these values.

\*3 Use within the ambient temperature range. When enclosed in a box, the internal temperatures must not exceed the ambient temperature range.

\*4 The lowest speed of the speed control range is the speed at which the motor does not stop under 100% load.

\*5 Speed regulation is defined as follows:

$$\text{Speed regulation} = \frac{\text{No-load-speed} - \text{Full-load-speed}}{\text{Rated speed}} \times 100\%$$

The motor speed may change due to voltage variations or amplifier drift and changes in processing resistance due to temperature variation.

These ratios of the speed changes to the rated speed represent the speed regulation due to voltage and temperature variations.

\*6 N is the number of encoder pulses.

### 4.3.2 Overload Characteristics

The Servopack has a built-in overload protective function to protect the Servopack and Servomotor from overload. Therefore, the Servopack allowable power is limited by the overload protective function, as shown below.

The overload detection level is quoted under **hot start** conditions at a motor ambient temperature of 40°C.

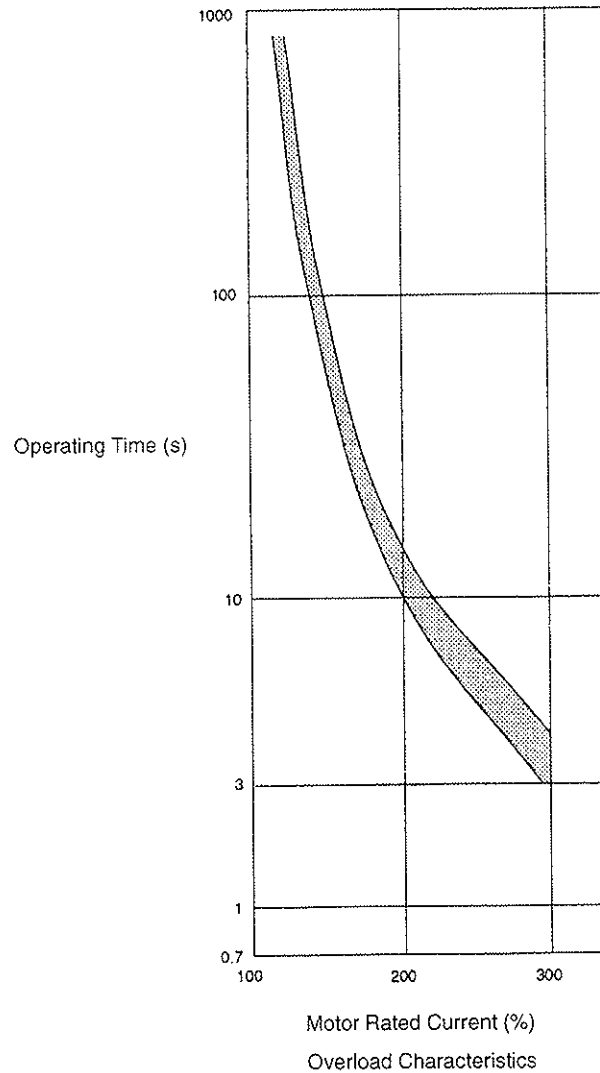

#### Hot Start

Indicates that both Servopack and Servomotor have run long enough at rated load to be thermally saturated.

### 4.3.3 Starting Time and Stopping Time

1) The motor starting time ( $t_r$ ) and stopping time ( $t_f$ ) under constant load are calculated by the following formulas. The motor viscous torque and friction torque are ignored.

$$\text{Starting Time: } t_r = 104.7 \times \frac{N_R (J_M + J_L)}{K_t I_R (\alpha - \beta)} \text{ [ms]}$$

$$\text{Stopping Time: } t_f = 104.7 \times \frac{N_R (J_M + J_L)}{K_t I_R (\alpha + \beta)} \text{ [ms]}$$

$N_R$ : Motor rated speed (r/min.)

$J_M$ : Motor moment of inertia ( $\text{kg}\cdot\text{m}^2 = \text{lb}\cdot\text{in}\cdot\text{s}^2$ ) ... ( $\text{GD}^2_M/4$ )

$J_L$ : Load converted to shaft moment of inertia ( $\text{kg}\cdot\text{m}^2$ ) .. ( $\text{GD}^2_L/4$ )

$K_t$ : Motor torque constant ( $\text{N}\cdot\text{m}/\text{A} = \text{lb}\cdot\text{in}/\text{A}$ )

$I_R$ : Motor rated current (A)

$\alpha = I_P/I_R$ : Accel/decel current coefficient

[where  $I_P$  is accel/decel current (accel/decel current is  $\alpha$  times the motor rated current) (A)]

$\beta = I_L/I_R$ : Load current coefficient

[ $I_L$ : Load torque equivalent current (load current is  $\beta$  times the motor rated current) (A)]

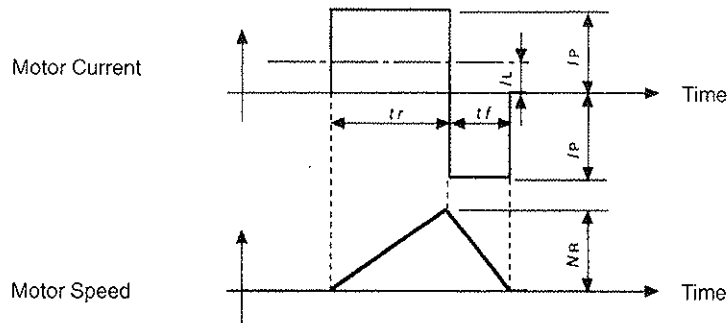

Motor Current (size) - Motor Speed Timing Chart

### 4.3.4 Load Inertia

1) The larger the load inertia becomes, the worse the movement response of the load. The size of the load inertia [ $J_L$ ] allowable when using a Servomotor depends on the motor capacity, as shown in the diagrams below.

- Small Load Inertia

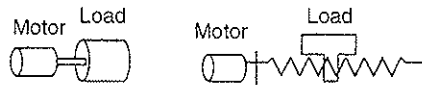

• Large Load Inertia

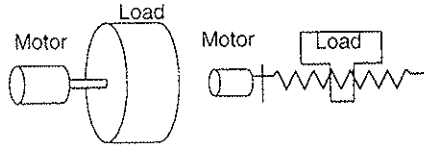

Load Inertia  
 $\text{kg}\cdot\text{m}^2 \times 10^{-4}$   
 $(\text{oz}\cdot\text{in}\cdot\text{s}^2 \times 10^{-3})$

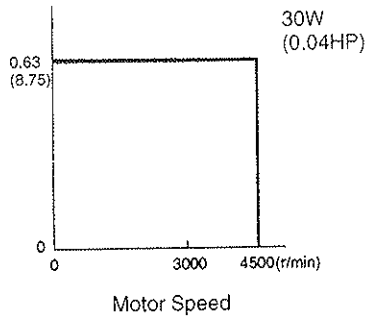

Load Inertia  
 $\text{kg}\cdot\text{m}^2 \times 10^{-4}$   
 $(\text{oz}\cdot\text{in}\cdot\text{s}^2 \times 10^{-3})$

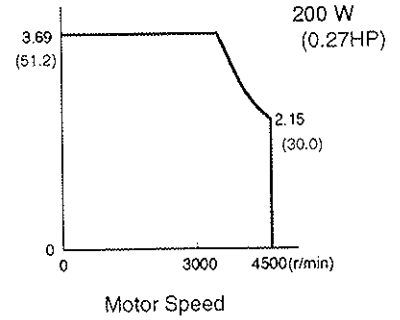

Load Inertia  
 $\text{kg}\cdot\text{m}^2 \times 10^{-4}$   
 $(\text{oz}\cdot\text{in}\cdot\text{s}^2 \times 10^{-3})$

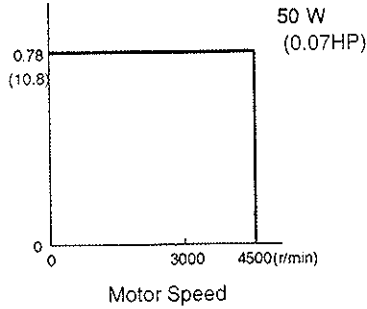

Load Inertia  
 $\text{kg}\cdot\text{m}^2 \times 10^{-4}$   
 $(\text{oz}\cdot\text{in}\cdot\text{s}^2 \times 10^{-3})$

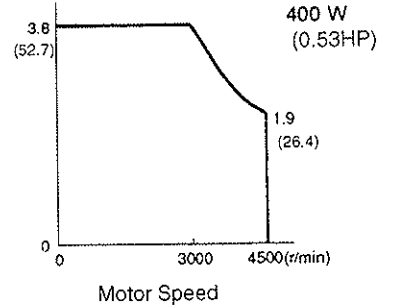

Load Inertia  
 $\text{kg}\cdot\text{m}^2 \times 10^{-4}$   
 $(\text{oz}\cdot\text{in}\cdot\text{s}^2 \times 10^{-3})$

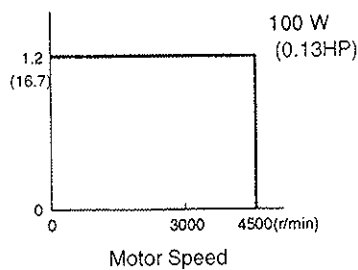

Load inertia  
 $\text{kg}\cdot\text{m}^2 \times 10^{-4}$   
 $(\text{oz}\cdot\text{in}\cdot\text{s}^2 \times 10^{-3})$

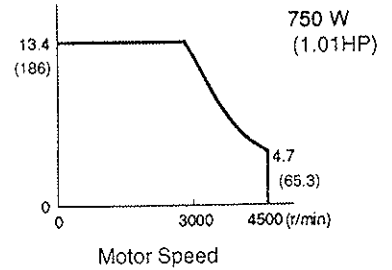

**Note** The above diagrams represent deceleration under maximum torque. Applying an acceleration/deceleration curve to the reference allows operation outside the range of the diagrams. (That is, characteristics change according to pattern of operation and load conditions).

- 2) An overvoltage alarm is likely during deceleration if the load inertia exceeds the range of the diagrams. Take one of the countermeasures below.
  - a) Reduce the torque limit value.
  - b) Reduce the deceleration rate.
  - c) Reduce the maximum speed used.
  - d) Add a regenerative unit.

### 4.3.5 Overhanging Loads

- 1) A Servomotor may not be operated under an overhanging load, that is a load which tends to continually rotate the motor.  
 Under an overhanging load (e.g. when the direction of the torque applied by the motor is opposite from the direction of shaft rotation), the Servopack regenerative brake is applied continuously and the regenerative energy of the load may exceed the allowable range and damage the Servopack.  
 The regenerative brake capacity of the SGDL Servopack is rated for short-time operation, approximately equivalent to the deceleration stopping time.

- Overhanging Load Example 1: Motor drive for vertical axis, using no counterweight

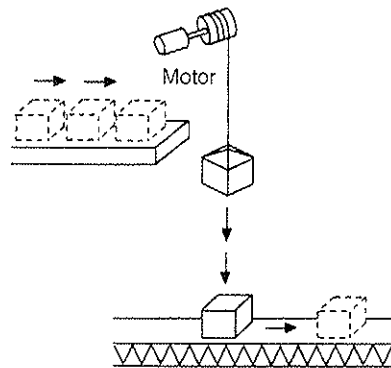

- Overhanging Load Example 2: Tension control drive

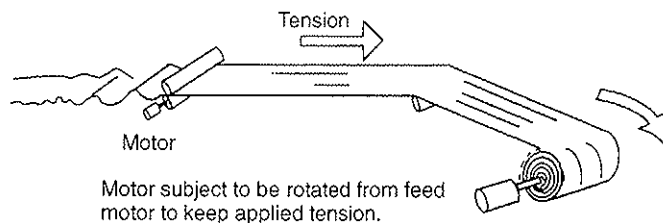

## 4.3.6 Power Consumption

Servopack SGDL-		In-rush Current (Peak Value) A	Output Current (Effective Value) A	Power Loss W			<Total> Power Loss W
				Main Circuit	Control Circuit	DB Circuit	
Supply Voltage 200V	A3AS (30W-0.04HP)	20	0.42	2.9	13	Varies depending on operating conditions	15.9
	A5AS (50W-0.07HP)	20	0.6	4.2	13		17.2
	01AS (100W-0.13HP)	30	0.87	6.3	13		19.3
	02AS (200W-0.27HP)	30	2.0	14.5	13		27.5
	04AS (400W-0.53HP)	30	2.6	22.2	13		35.2
	08AS (750W-1.01HP)	70	4.4	36.1	13		49.1
Supply Voltage 100V	A3BS (30W-0.04HP)	10	0.63	2.9	13	15.9	
	A5BS (50W-0.07HP)	15	0.9	4.4	13	17.4	
	01BS (100W-0.13HP)	15	2.2	12.0	13	25.0	
	02BS (200W-0.27HP)	15	2.7	16.2	13	29.2	
	03BS (300W-0.40HP)	35	3.7	20.1	13	33.1	

## 4.4 $\Sigma$ -L Series Dimensional Drawings

This section presents dimensional drawings of the  $\Sigma$ -L Series Servomotor, Servopack, and Digital Operator.

4.4.1	Servomotor Dimensional Drawings .....	164
4.4.2	Servopack Dimensional Drawings .....	178
4.4.3	Digital Operator Dimensional Drawings .....	181

### 4.4.1 Servomotor Dimensional Drawings

1) The dimensional drawings of the SGML Servomotors are broadly grouped into the following two categories.

- a) Incremental encoder, no brake (from page 165)
- b) Incremental encoder, with brake (from page 169)

Motor capacities are available as 30 W (0.04 HP), 50 W (0.07 HP), 100 W (0.13 HP), 200 W (0.27 HP), 300 W (0.40 HP), 400 W (0.53 HP), 750 W (1.01 HP). These are grouped into three categories, as follows:

- 30W (0.04 HP), 50W (0.07 HP), 100W (0.13 HP)
- 200W (0.27 HP), 300W (0.40 HP), 400W (0.53 HP)
- 750W (1.01 HP)



(1) SGML Servomotor  
Incremental encoder, no brake

- 30W (0.04 HP), 50W (0.07 HP), 100W (0.13 HP)

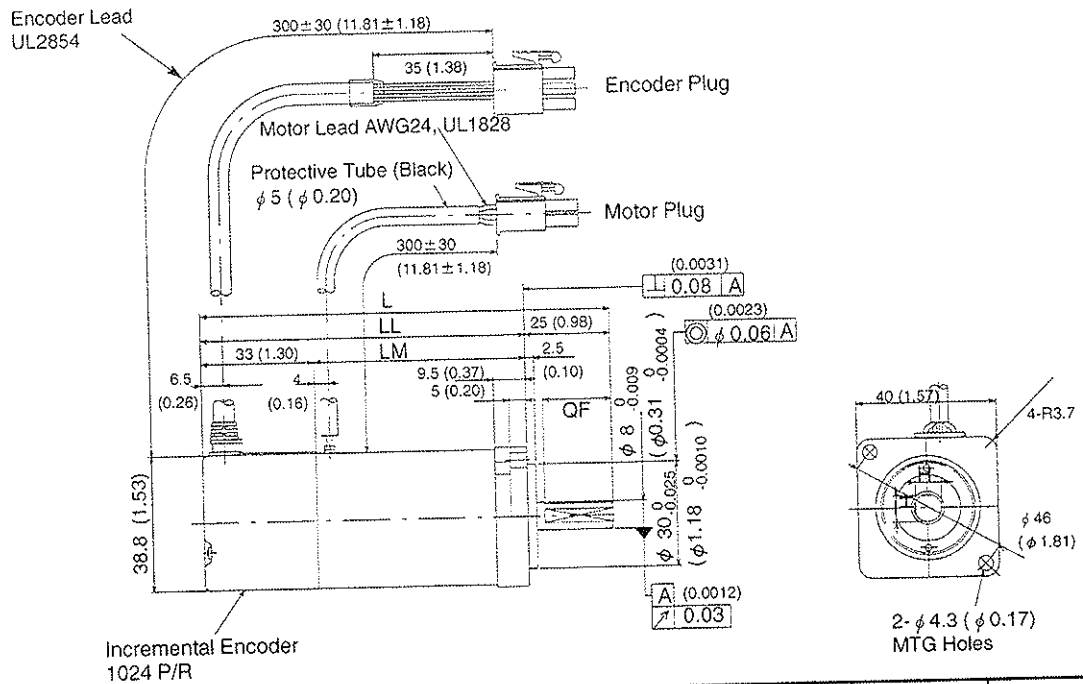

Type SGML-	L	LL	LM	QF	H	Output W (HP)	Approx. mass kg (lb)	Allowable radial load N (lb)	Allowable thrust load N (lb)
A3AF12	94.5 (3.72)	69.5 (2.74)	36.5 (1.44)	W/O flat key seat		30 (0.04)	0.3 (0.66)	68 (15)	54 (12)
A3BF12				20 (0.79)	7.5 (0.30)				
A3AF13									
A3BF13									
A5AF12	102.0 (4.02)	77.0 (3.03)	44.0 (1.73)	W/O flat key seat		50 (0.07)	0.4 (0.88)	78 (18)	
A5BF12				20 (0.79)	7.5 (0.30)				
A5AF13									
A5BF13									
01AF12	119.5 (4.70)	94.5 (3.72)	61.5 (2.42)	W/O flat key seat		100 (0.13)	0.5 (1.10)	78 (18)	
01BF12				20 (0.79)	7.5 (0.30)				
01AF13									
01BF13									

- Note**
- 1) The detector uses an incremental encoder 1024 P/R.
  - 2) Type "A" indicates 200 V specification, and type "B" indicates 100 V specification.
  - 3) The quoted allowable radial load is the value at a position 20 mm (0.79 in.) from the motor mounting surface.

# SERVO SELECTION AND DATA SHEETS

## 4.4.1 Servomotor Dimensional Drawings cont.

- 200 W (0.27 HP), 300 W (0.04 HP, 100 VAC only), 400 W (0.53 HP, 200 VAC only)

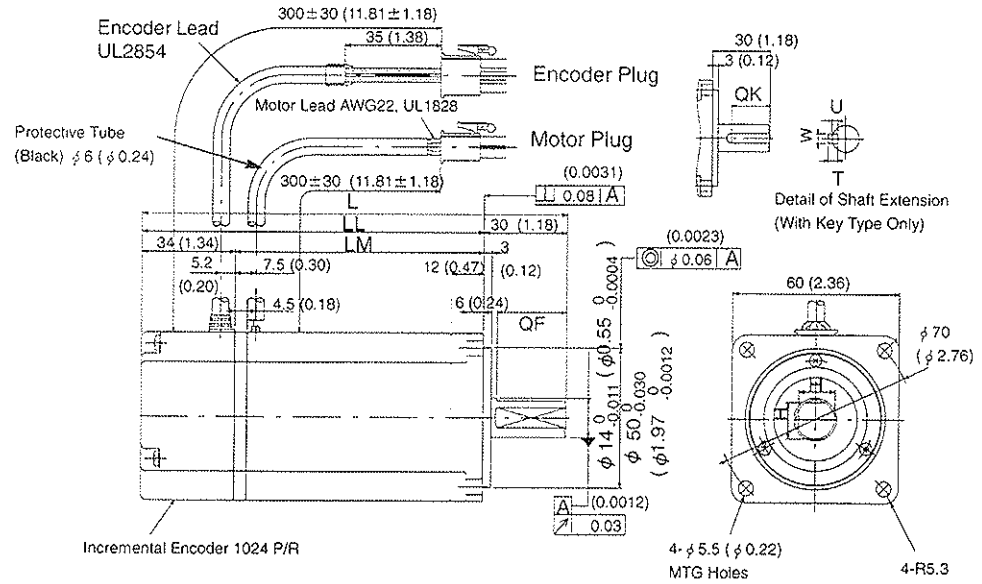

Type SGML-	L	LL	LM	QK	U	W	T	QF	H	Output W (HP)	Approx. mass kg (lb)	Allowable radial load N (lb)	Allowable thrust load N (lb)		
02AF12	126.5 (4.98)	96.5 (3.80)	62.5 (2.46)	No key				W/O flat key seat		200 (0.27)	1.1 (2.43)	245 (55.1)	74 (17)		
02BF12								25 (0.98)	13 (0.51)						
02AF13								W/O flat key seat							
02BF13								W/O flat key seat							
02AF14								20 (0.79)	3 (0.12)					5 (0.20)	5 (0.20)
02BF14								W/O flat key seat							
03BF12	154.5 (6.08)	124.5 (4.90)	90.5 (3.56)	No key				W/O flat key seat		300 (0.40)	1.7 (3.75)				
03BF13								25 (0.98)	13 (0.51)						
03BF14								W/O flat key seat							
04AF12								W/O flat key seat							
04AF13	No key				W/O flat key seat		400 (0.53)								
04AF14					20 (0.79)	3 (0.12)					5 (0.20)	5 (0.20)	W/O flat key seat		

- Note**
- 1) The detector uses an incremental encoder 1024 P/R.
  - 2) Type "A" indicates 200 V specification, and type "B" indicates 100 V specification.
  - 3) "02A(B)F14", "03BF14" and "04AF14" have a keyed shaft. The keyway complies with JIS B 1301-1976 (precision). A straight key is supplied.
  - 4) The quoted allowable radial load is the value at a position 25 mm (0.98 in.) from the motor mounting surface.

- 750 W (1.01 HP, 200 VAC only)

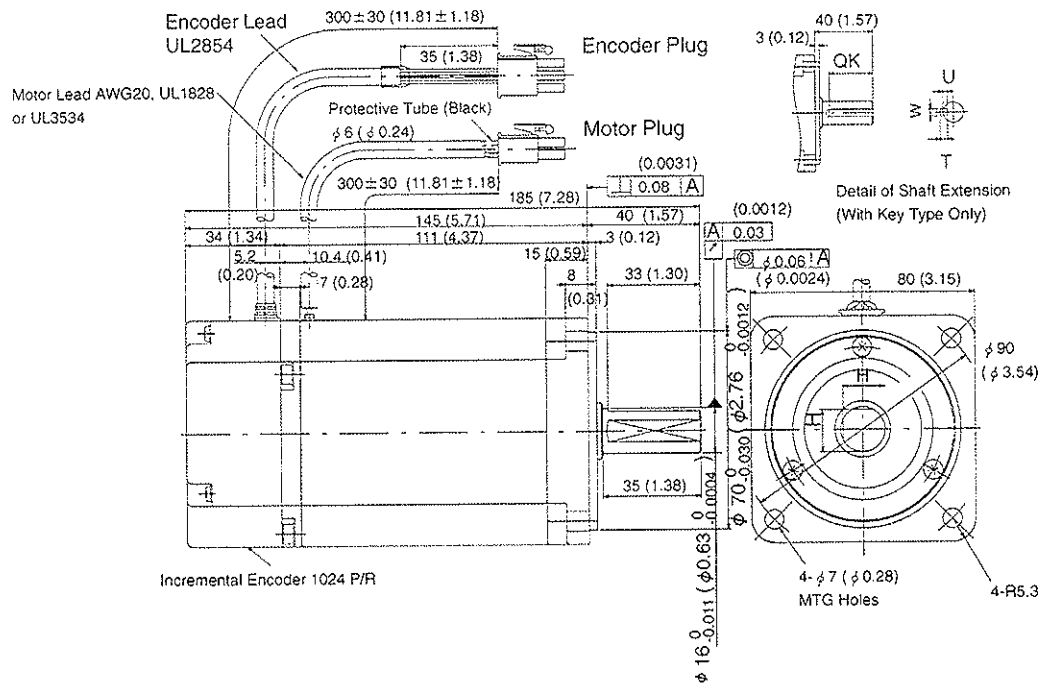

Type SGML-	QK	U	W	T	QF	H	Output W (HP)	Approx. mass kg (lb)	Allowable radial load N (lb)	Allowable thrust load N (lb)
08AF12	No key				W/O flat key seat		750 (1.01)	3.4 (7.50)	392 (88)	147 (33)
08AF13					33 (1.30)	15 (0.59)				
08AF14	30 (1.18)	3 (0.12)	5 (0.20)	5 (0.20)	W/O flat key seat					

## SERVO SELECTION AND DATA SHEETS

### 4.4.1 Servomotor Dimensional Drawings cont.

- Note**
- 1) The detector uses an incremental encoder 1024 P/R.
  - 2) Type "A" indicates 200 V specification.
  - 3) "08AF14" has a keyed shaft. The keyway complies with JIS B 1301-1976 (precision). A straight key is supplied.
  - 4) The quoted allowable radial load is the value at a position 25 mm (0.98 in.) from the motor mounting surface.

• Details of Motor and Encoder Plugs (Common for 30 W (0.04 HP) to 750 W (1.01 HP))

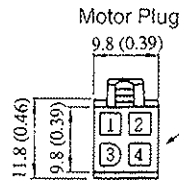

Plug : 172167-1 (AMP)  
 Pin: (30 to 100W)  
 170359-1 or 170363-1  
 (200W to 750W)  
 170360-1 or 170364-1

Connected to  
 Cap: 172159-1  
 Socket: 170362 -1 or 170366-1

#### Motor Wiring Specifications

1	U phase	Red
2	V phase	White
3	W phase	Blue
4	FG	Green

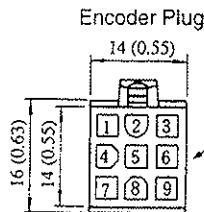

Plug: 172169-1 (Made by AMP)  
 Pin: 170359-1 or 170363-1  
 Connected to  
 Cap: 172161-1  
 Socket: 170361-1 or 170365-1

#### Incremental Encoder Wiring Specifications

1	A channel output	Blue
2	A channel output	Blue/Black
3	B channel output	Yellow
4	B channel output	Yellow/Black
5	C channel output	Green
6	C channel output	Green/Black
7	0V (power supply)	Gray
8	+5V (power supply)	Red
9	FG (Frame Ground)	Orange

(2) SGML Servomotor  
Incremental encoder, with brake

- 30W (0.04 HP), 50W (0.07 HP), 100W (0.13 HP)

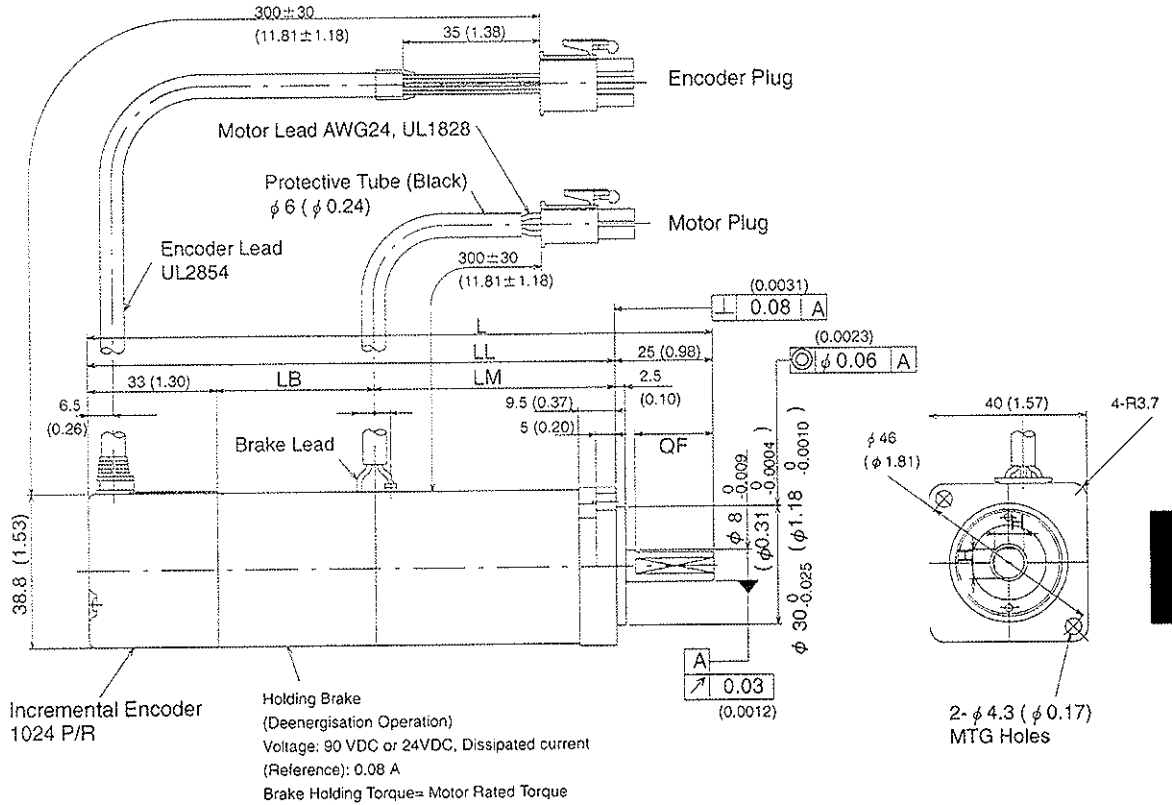

Type SGML-	L	LL	LM	QF	H	Output W (HP)	Approx. mass kg (lb)	Allowable radial load N (lb)	Allowable thrust load N (lb)
A3AF12*	126.0 (4.96)	101.0 (3.98)	36.5 (1.44)	W/O flat key seat		30 (0.04)	0.6 (1.32)	68 (15)	54 (12)
A3BF12*				20 (0.79)	7.5 (0.30)				
A3AF13*									
A3BF13*									
A5AF12*	133.5 (5.26)	108.5 (4.27)	44.0 (1.73)	W/O flat key seat		50 (0.07)	0.7 (1.54)	78 (18)	54 (12)
A5BF12*				20 (0.79)	7.5 (0.30)				
A5AF13*									
A5BF13*									
01AF12*	160.0 (6.30)	135.0 (5.31)	61.5 (2.42)	W/O flat key seat		100 (0.13)	0.8 (1.76)	78 (18)	54 (12)
01BF12*				20 (0.79)	7.5 (0.30)				
01AF13*									
01BF13*									

- Note**
- 1) The detector uses an incremental encoder 1024 P/R.
  - 2) Type "A" indicates 200 V specification, and type "B" indicates 100 V specification.
  - 3) The quoted allowable radial load is the value at a position 20 mm (0.79 in.) from the motor mounting surface.
  - 4) The electromagnetic brake is only to hold the load in position and cannot be used to stop the motor.
  - 5) "※" of the type designation depends on the brake power voltage: "B" for 90 VDC and "C" for 24VDC.

- 200 W (0.53 HP), 300 W (0.40 HP, 100 VAC only), 400 W (0.27 HP, 200 VAC only)

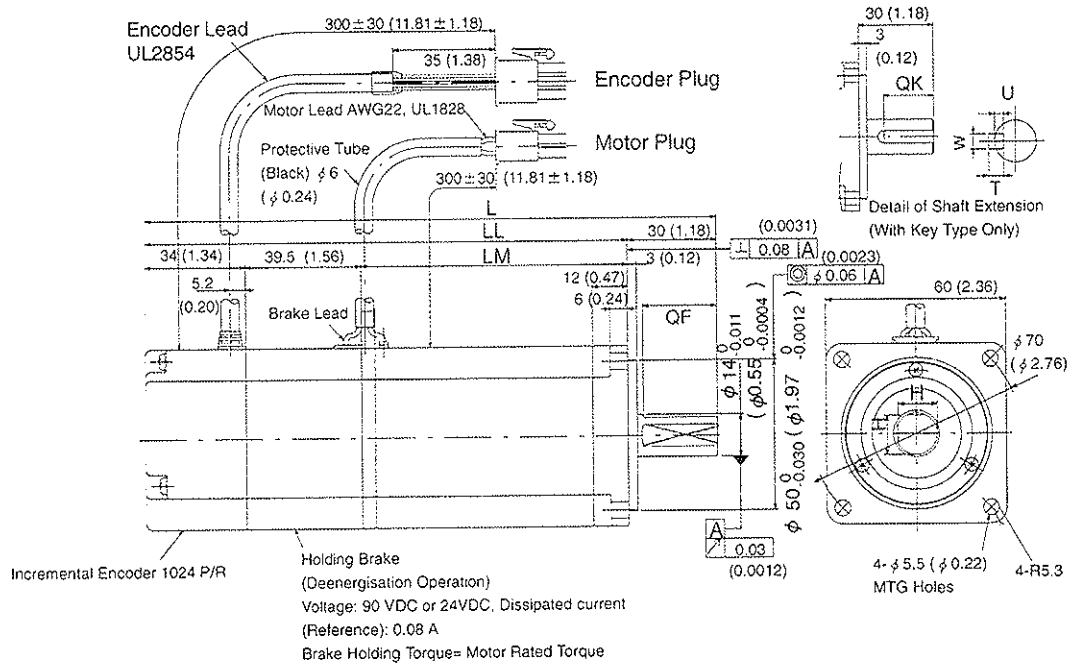

Type SGML-	L	LL	LM	QK	U	W	T	QF	H	Output W (HP)	Approx. mass kg (lb)	Allowable radial load N (lb)	Allowable thrust load N (lb)		
02AF12*	166.0 (6.54)	136.0 (5.35)	62.5 (2.46)	No key				W/O flat key seat		200 (0.27)	1.6 (3.53)	245 (55.1)	74 (17)		
02BF12*				25 (0.98)		13 (0.51)									
02AF13*				20 (0.79)				3 (0.12)						5 (0.20)	
02BF13*				20 (0.79)				3 (0.12)						5 (0.20)	
02AF14*				20 (0.79)				3 (0.12)						5 (0.20)	
02BF14*				20 (0.79)				3 (0.12)						5 (0.20)	
03BF12*	194.0 (7.64)	164.0 (6.46)	90.5 (3.56)	No key				W/O flat key seat		300 (0.40)	2.2 (4.85)	245 (55.1)	74 (17)		
03BF13*				25 (0.98)		13 (0.51)									
03BF14*				20 (0.79)				3 (0.12)						5 (0.20)	
04AF12*				20 (0.79)				3 (0.12)						5 (0.20)	
04AF13*	20 (0.79)				3 (0.12)		5 (0.20)		400 (0.53)	2.2 (4.85)	245 (55.1)	74 (17)			
04AF14*	20 (0.79)				3 (0.12)		5 (0.20)								

**Note** 1) The detector uses an incremental encoder 1024 P/R.

2) Type "A" indicates 200 V specification, and type "B" indicates 100 V specification.

**SERVO SELECTION AND DATA SHEETS**

*4.4.1 Servomotor Dimensional Drawings cont.*

- 3) "02A(B)F14\*", "03BF14\*" and "04AF14\*" have a keyed shaft. The keyway complies with JIS B 1301-1976 (precision). A straight key is supplied.
- 4) The quoted allowable radial load is the value at a position 25 mm (0.98 in.) from the motor mounting surface.
- 5) The electromagnetic brake is only to hold the load in position and cannot be used to stop the motor.
- 6) "\*" of the type designation depends on the brake power voltage: "B" for 90 VDC and "C" for 24VDC.

• 750 W (1.01 HP)

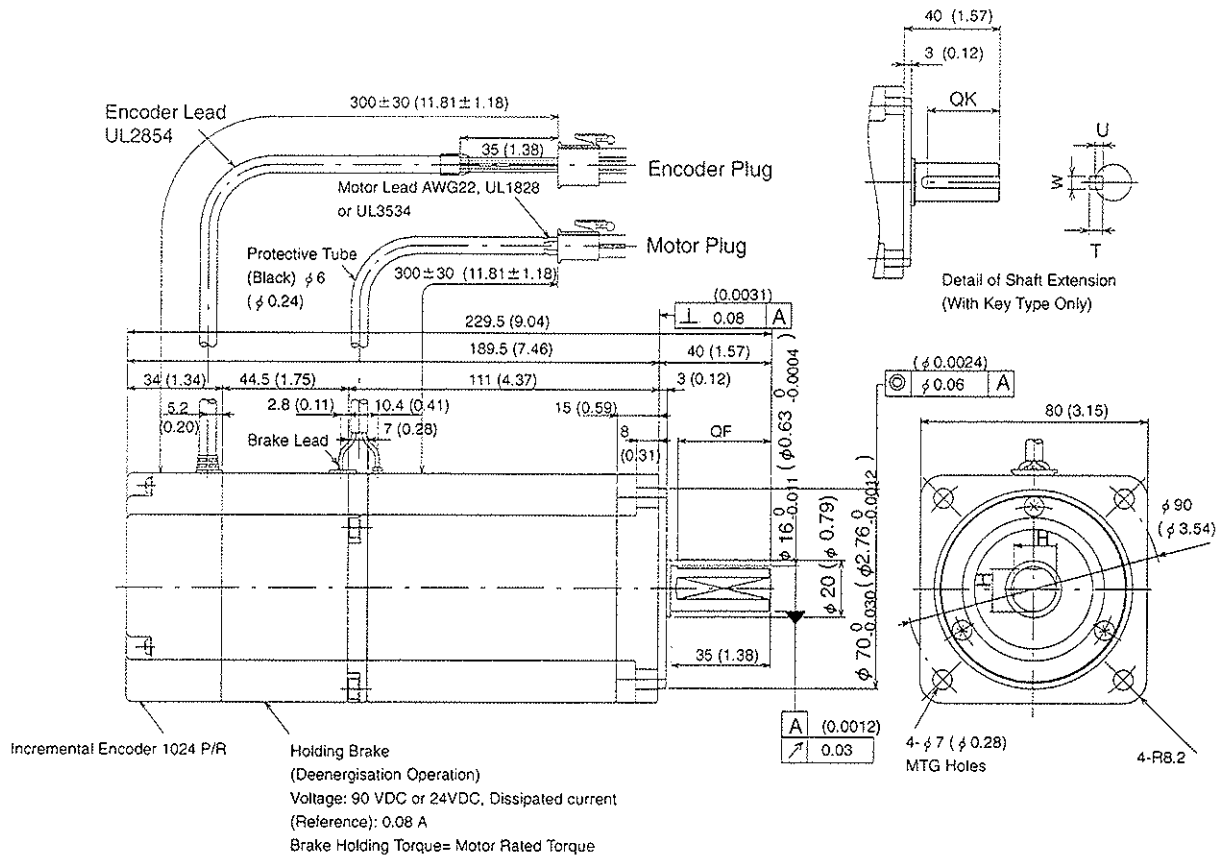

Type SGML-	QK	U	W	T	QF	H	Output W (HP)	Approx. mass kg (lb)	Allowable radial load N (lb)	Allowable thrust load N (lb)
08AF12*	No key				W/O flat key seat		750 (1.01)	4.3 (9.48)	392 (88)	147 (33)
08AF13*					33 (1.30)	15 (0.59)				
08AF14*	30 (1.18)	3 (0.12)	5 (0.20)	5 (0.20)	W/O flat key seat					



- Note**
- 1) The detector uses an incremental encoder 1024 P/R.
  - 2) Type "A" indicates 200 V specification.
  - 3) "08AF14※" has a keyed shaft. The keyway complies with JIS B 1301-1976 (precision). A straight key is supplied.
  - 4) The quoted allowable radial load is the value at a position 25 mm (0.98 in.) from the motor mounting surface.
  - 5) The electromagnetic brake is only to hold the load in position and cannot be used to stop the motor.
  - 6) "※" of the type designation depends on the brake power voltage: "B" for 90 VDC and "C" for 24VDC.

• Details of Motor and Encoder Plugs (Common for 30 W (0.04 HP) to 750 W (1.01 HP))

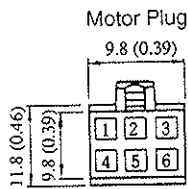

Plug : 172168-1 (AMP)  
 Pin: (30 to 100W)  
 170359-1 or 170363-1  
 (200W to 750W)  
 170360-1 or 170364-1  
 Connected to  
 Cap: 172160-1  
 Socket: 170362-1 or 170366-1

Motor Wiring Specifications

1	U phase	Red
2	V phase	White
3	W phase	Blue
4	FG	Green/Yellow
5	Brake terminal	Red
6	Brake terminal	Black

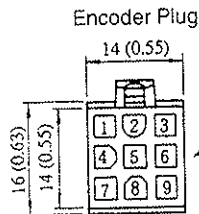

Plug: 172169-1 (AMP)  
 Pin: 170359-1 or 170363-1  
 Connected to  
 Cap: 172161-1  
 Socket: 170361-1 or 170365-1

Incremental Encoder Wiring Specifications

1	A channel output	Blue
2	A channel output	Blue/Black
3	B channel output	Yellow
4	B channel output	Yellow/Black
5	C channel output	Green
6	C channel output	Green/Black
7	0V (power supply)	Gray
8	+5V (power supply)	Red
9	FG (Frame Ground)	Orange



**SERVO SELECTION AND DATA SHEETS**

4.4.1 Servomotor Dimensional Drawings cont.

(3) SGML Servomotor  
Incremental encoder, with standard backlash gears

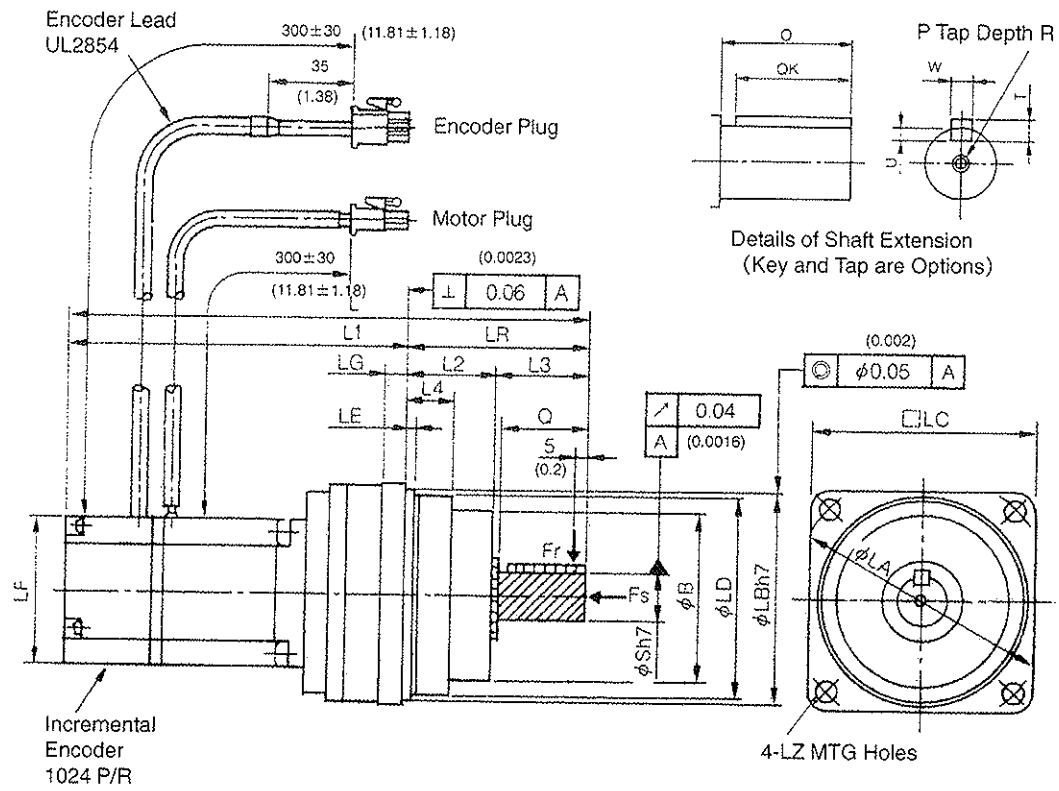

MOTOR TYPE SGML-	L	L1	LR	LG	L2	L3	L4	LE	LB	LF	LD	LA
A3□FJ1□	156.5	101.5	55 (2.17)	8 (0.32)	28 (1.10)	27 (1.06)	17 (0.67)	4 (0.16)	56 (2.21)	38.8 (1.53)	55.5 (2.19)	70 (2.76)
A3□FJ2□	(6.17)	(4.0)										
A3□FJ3□	171.5	116.5										
A3□FJ4□	(6.76)	(4.07)										
A5□FJ1□	164 (6.46)	109 (3.80)	60 (2.34)	9 (0.35)	30 (1.18)	30 (1.18)	14.5 (0.57)	4 (0.16)	56 (2.21)	38.8 (1.53)	55.5 (2.19)	70 (2.76)
A5□FJ2□	174 (6.86)	114 (4.49)										
A5□FJ3□	191 (7.53)	131 (5.16)										
A5□FJ4□												
01□FJ1□	191.5 (7.54)	131.5 (5.18)	74 (2.92)	10 (0.39)	36 (1.42)	38 (1.50)	19.5 (0.77)	4 (0.16)	65 (2.56)	38.8 (1.53)	63 (2.48)	80 (3.15)
01□FJ2□												
01□FJ3□	227 (8.94)	153 (6.03)										
01□FJ4□												
02□FJ1□	212 (8.35)	138 (5.54)	84 (3.31)	12 (0.47)	40 (1.58)	44 (1.73)	23 (0.91)	4 (0.16)	85 (3.35)	60 (2.36)	83 (3.27)	105 (4.14)
02□FJ2□												
02□FJ3□	249.5 (9.83)	165.5 (6.52)										
02□FJ4□												
03BFJ1□	240 (9.46)	166 (6.54)	84 (3.31)	12 (0.47)	40 (1.58)	44 (1.73)	23 (0.91)	4 (0.16)	85 (3.35)	60 (2.36)	83 (3.27)	105 (4.14)
03BFJ2□	256.5 (10.11)	172.5 (6.80)										
03BFJ3□	305.5 (12.04)	200.5 (7.80)										
03BFJ4□												
04AFJ1□	240 (9.46)	166 (6.54)	105 (4.14)	13 (0.51)	45 (1.77)	60 (2.36)	26.5 (1.04)	4 (0.16)	85 (3.35)	60 (2.36)	83 (3.27)	105 (4.14)
04AFJ2□	256.5 (10.11)	172.5 (6.80)										
04AFJ3□	305.5 (12.04)	200.5 (7.80)										
04AFJ4□												
08AFJ1□	277 (10.91)	193 (7.60)	107 (4.22)	15 (0.59)	42 (1.65)	65 (2.61)	-	4 (0.16)	100 (3.94)	80 (3.15)	98 (3.86)	120 (4.72)
08AFJ2□	301 (11.86)	196 (7.72)										
08AFJ3□	330 (13.00)	223 (8.79)										
08AFJ4□												

4

## SERVO SELECTION AND DATA SHEETS

### 4.4.1 Servomotor Dimensional Drawings cont.

MOTOR TYPE SGML-	LC	LZ	S	B	Q	QK	W	T	U	P	R	Mass kg (lb)
A3□FJ1□	60 (2.36)	5.5 (0.22)	14 (0.55)	47 (1.85)	25 (0.99)	20 (0.79)	5 (0.20)	5 (0.20)	3 (0.12)	M4	8 (0.32)	0.9 (2.0)
A3□FJ2□												1 (2.2)
A3□FJ3□												
A3□FJ4□												
A5□FJ1□	60 (2.36)	5.5 (0.22)	14 (0.55)	47 (1.85)	25 (0.99)	20 (0.79)	5 (0.20)	5 (0.20)	3 (0.12)	M4	8 (0.32)	1 (2.2)
A5□FJ2□	70 (2.76)	6.6 (0.26)	16 (0.63)	57 (2.25)	28 (1.10)	25 (0.99)						1.2 (2.6)
A5□FJ3□												1.3 (2.9)
A5□FJ4□												
01□FJ1□	70 (2.76)	6.6 (0.26)	16 (0.63)	57 (2.25)	28 (1.10)	25 (0.99)	5 (0.20)	5 (0.20)	3 (0.12)	M4	8 (0.32)	1.3 (2.9)
01□FJ2□												
01□FJ3□	90 (3.55)	9 (0.35)	20 (0.79)	69 (2.72)	36 (1.42)	32 (1.26)	6 (0.24)	6 (0.24)	3.5 (0.14)	M5	10 (0.39)	2.4 (5.3)
01□FJ4□												
02□FJ1□	90 (3.55)	9 (0.35)	20 (0.79)	69 (2.72)	36 (1.42)	32 (1.26)	6 (0.24)	6 (0.24)	3.5 (0.14)	M5	10 (0.39)	2.8 (6.2)
02□FJ2□												
02□FJ3□	105 (4.14)	9 (0.35)	25 (0.99)	82 (3.23)	42 (1.65)	36 (1.42)	8 (0.32)	7 (0.28)	4 (0.16)	M6	12 (0.47)	4.2 (9.2)
02□FJ4□												
03BFJ1□	90 (3.55)	9 (0.35)	20 (0.79)	69 (2.72)	36 (1.42)	32 (1.26)	6 (0.24)	6 (0.24)	3.5 (0.14)	M5	10 (0.39)	3.4 (7.5)
03BFJ2□	105 (4.14)		25 (0.99)	82 (3.23)	42 (1.65)	36 (1.42)	8 (0.32)	7 (0.28)	4 (0.16)	M6	12 (0.47)	4.3 (9.5)
03BFJ3□	120 (4.73)	11 (0.43)	32 (1.26)	93 (3.66)	58 (2.29)	50 (1.97)	10 (0.39)	8 (0.32)	5 (0.20)	M8	16 (0.63)	6.4 (14.1)
03BFJ4□												
04AFJ1□	90 (3.55)	9 (0.35)	20 (0.79)	69 (2.72)	36 (1.42)	32 (1.26)	6 (0.24)	6 (0.24)	3.5 (0.14)	M5	10 (0.39)	3.4 (7.5)
04AFJ2□	105 (4.14)		25 (0.99)	82 (3.23)	42 (1.65)	36 (1.42)	8 (0.32)	7 (0.28)	4 (0.16)	M6	12 (0.47)	4.33 (9.5)
04AFJ3□	120 (4.73)	11 (0.43)	32 (1.26)	93 (3.66)	58 (2.29)	50 (1.97)	10 (0.39)	8 (0.32)	5 (0.20)	M8	16 (0.63)	6.4 (14.1)
04AFJ4□												
08AFJ1□	105 (4.14)	9 (0.35)	25 (0.99)	82 (3.23)	42 (1.65)	36 (1.42)	8 (0.32)	7 (0.28)	4 (0.16)	M6	12 (0.47)	6 (1.3)
08AFJ2□	120 (4.73)	11 (0.43)	32 (1.26)	93 (3.66)	58 (2.29)	50 (1.97)	10 (0.39)	8 (0.32)	5 (0.20)	M8	16 (0.63)	7.5 (16.5)
08AFJ3□	145 (5.71)	14 (0.55)	40 (1.58)	134 (5.28)	60 (2.36)	45 (1.77)	12 (0.47)					
08AFJ4□										M10	20 (0.79)	12.4 (27.3)

- Details of Motor and Encoder Plugs (Common for 30 W (0.04 HP) to 750 W (1.01 HP)  
The details of motor and encoder plugs are the same as those for standard servomotors.

### 4.4.2 Servopack Dimensional Drawings

1) The dimension drawings of the SGDL Servopack are broadly grouped according to capacity into the following three categories.

a) 200V, 30W (0.04 HP) to 200 W (0.27HP) (Type: SGDL-A3AS to 02AS)  
 100V, 30W (0.04 HP) to 100 W (0.13HP) (Type: SGDL-A3BS to 01BS)

b) 200V, 400W (0.53 HP) (Type: SGDL-04AS)  
 100V, 200W (0.27 HP) (Type: SGDL-02BS)

c) 200V, 750W (1.01 HP) (Type: SGDL-08AS)  
 100V, 300W (0.40 HP) (Type: SGDL-03BS)

a) SGDL-A3AS to 02AS (200V, 30 (0.04 HP) to 200 W (0.27HP))  
 SGDL-A3BS to 01BS (100V, 30 (0.04 HP) to 100 W (0.13HP))

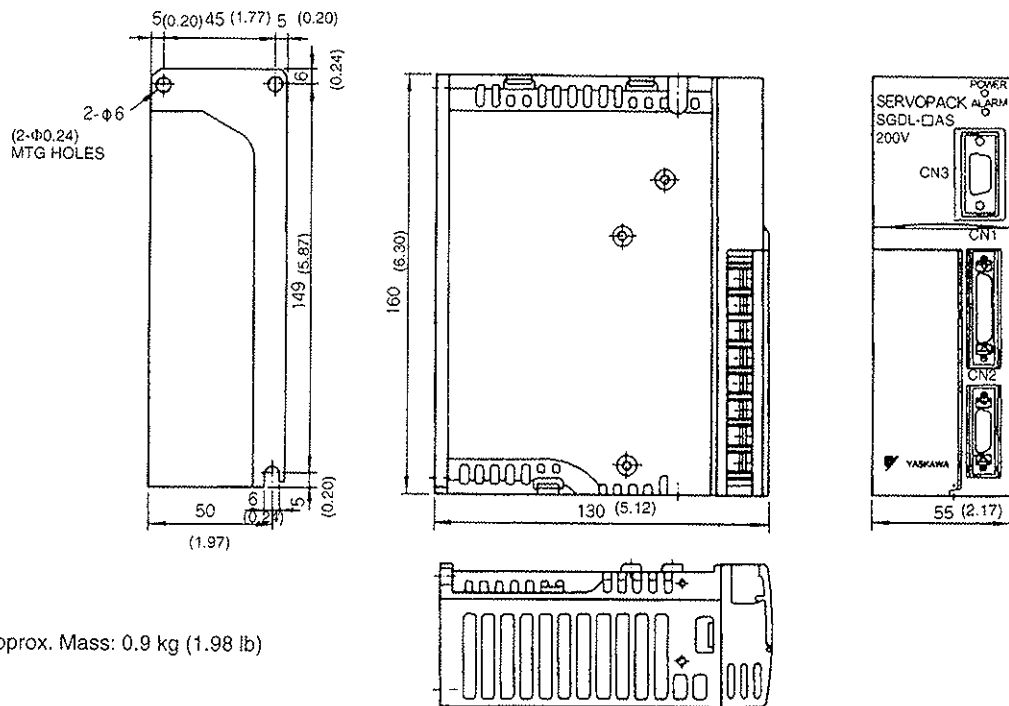

- b) SGDL-04AS (200V, 400W (0.53 HP))
- SGDL-02BS (100V, 200W (0.27 HP))

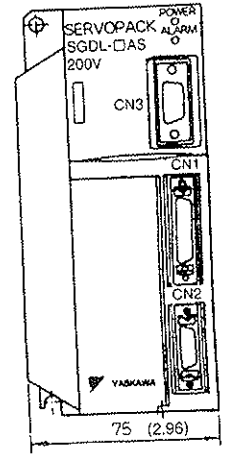
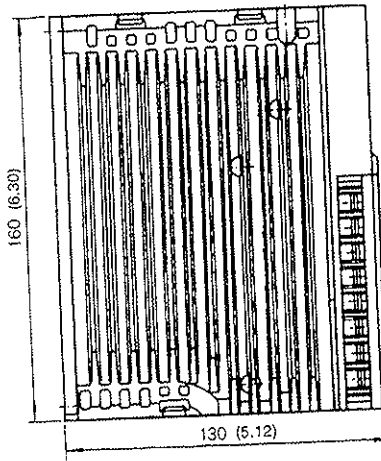
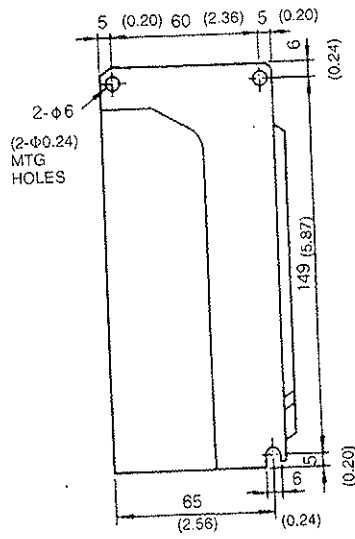

Approx. Mass: 1.2 kg (2.65 lb)

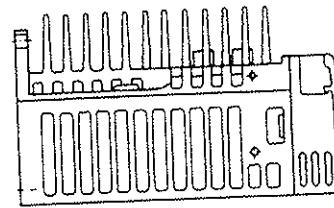

# SERVO SELECTION AND DATA SHEETS

## 4.4.2 Servopack Dimensional Drawings cont.

- c) SGDL-08AS (200V, 750W (1.01 HP))
- SGDL-03BS (100V, 300W (0.40 HP))

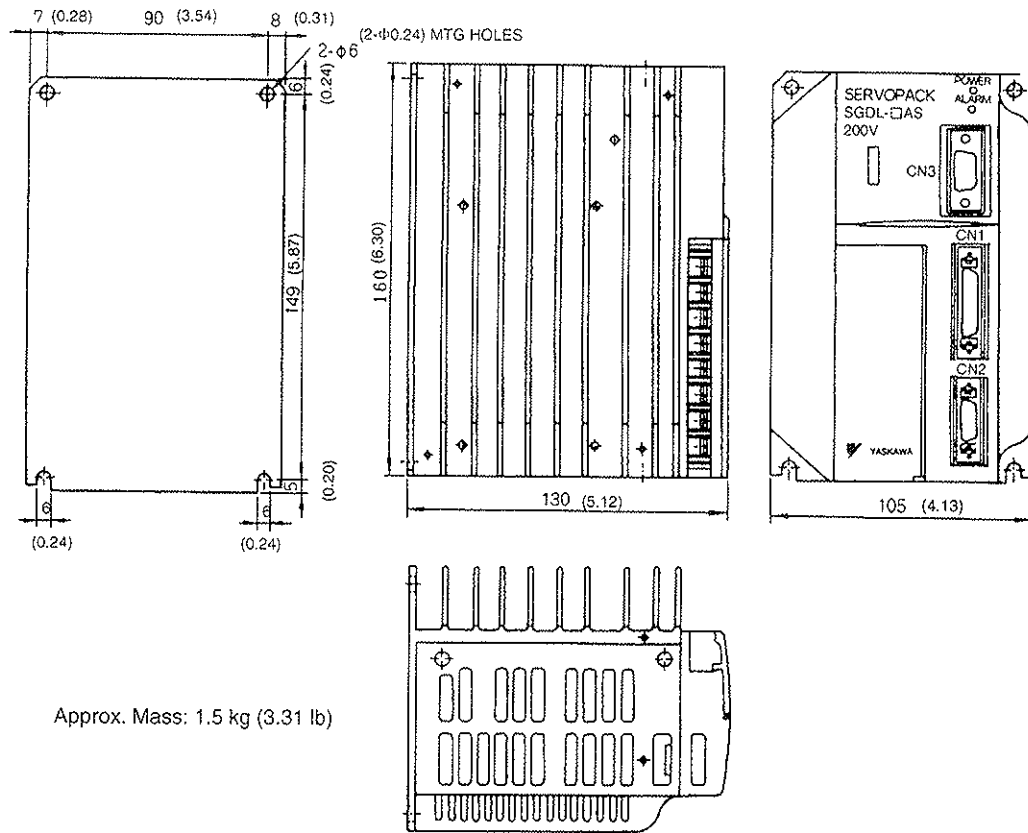



### 4.4.3 Digital Operator Dimensional Drawings

1) The following two types of Digital Operator are available.

a) JUSP-OP02A-1 Hand-held Type

b) JUSP-OP03A Mount Type

a) JUSP-OP02A-1

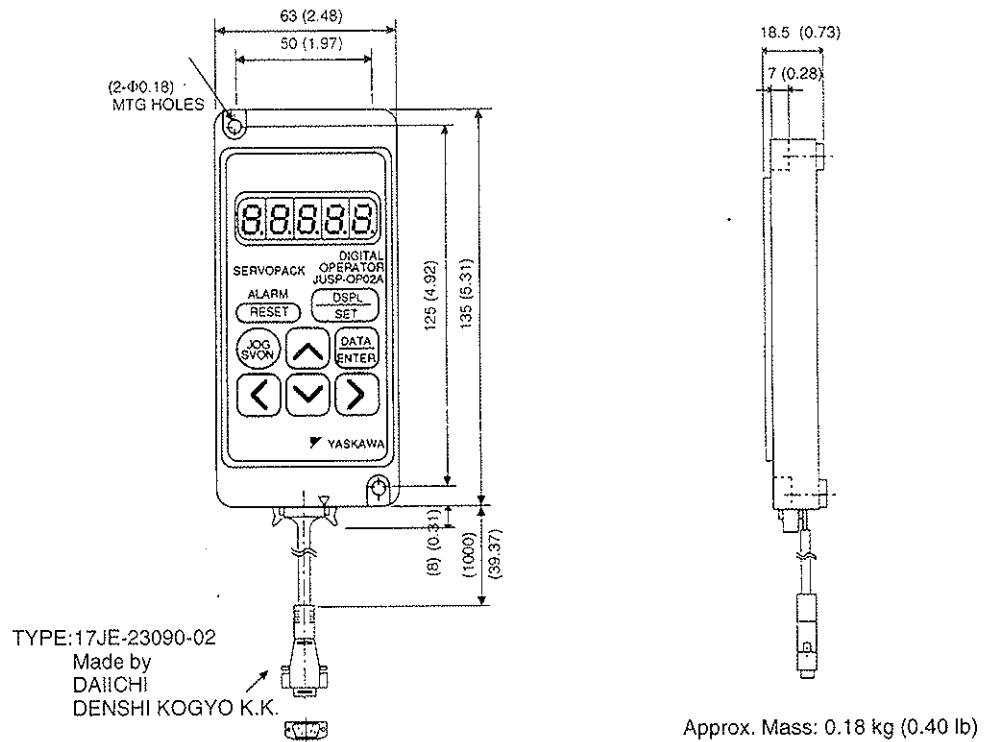

b) JUSP-OP03A

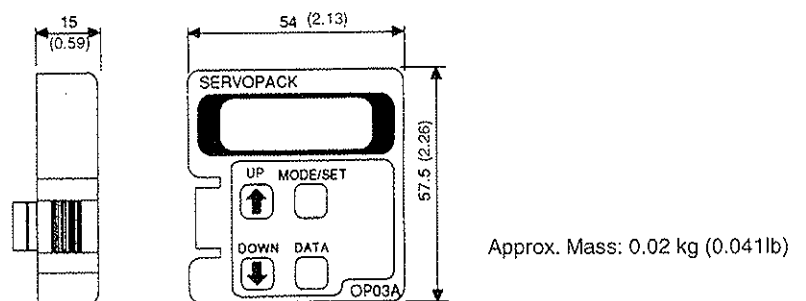

## 4.5 Selecting Peripheral Devices

▣ This section shows how to select peripheral devices using flowcharts.

4.5.1	Selecting Peripheral Devices .....	182
-------	------------------------------------	-----

### 4.5.1 Selecting Peripheral Devices

Select the peripheral devices using the flowcharts on the subsequent pages.

The items below are not included in the flowcharts. Refer to *4.6 Specifications and Dimensional Drawings of Peripheral Devices*.

- Cables for connecting PC and Servopack

<Flowchart for peripheral device selection>

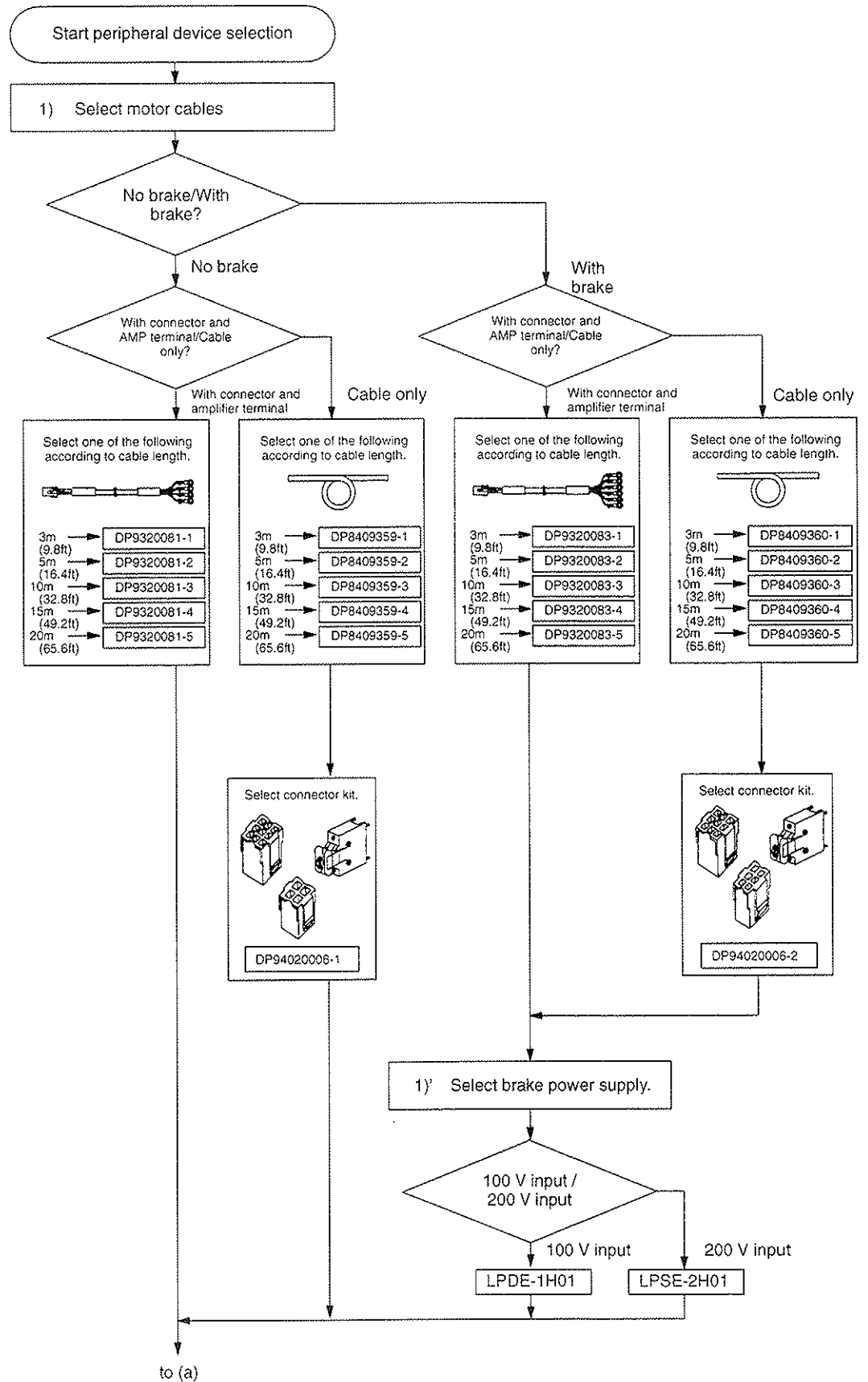

4

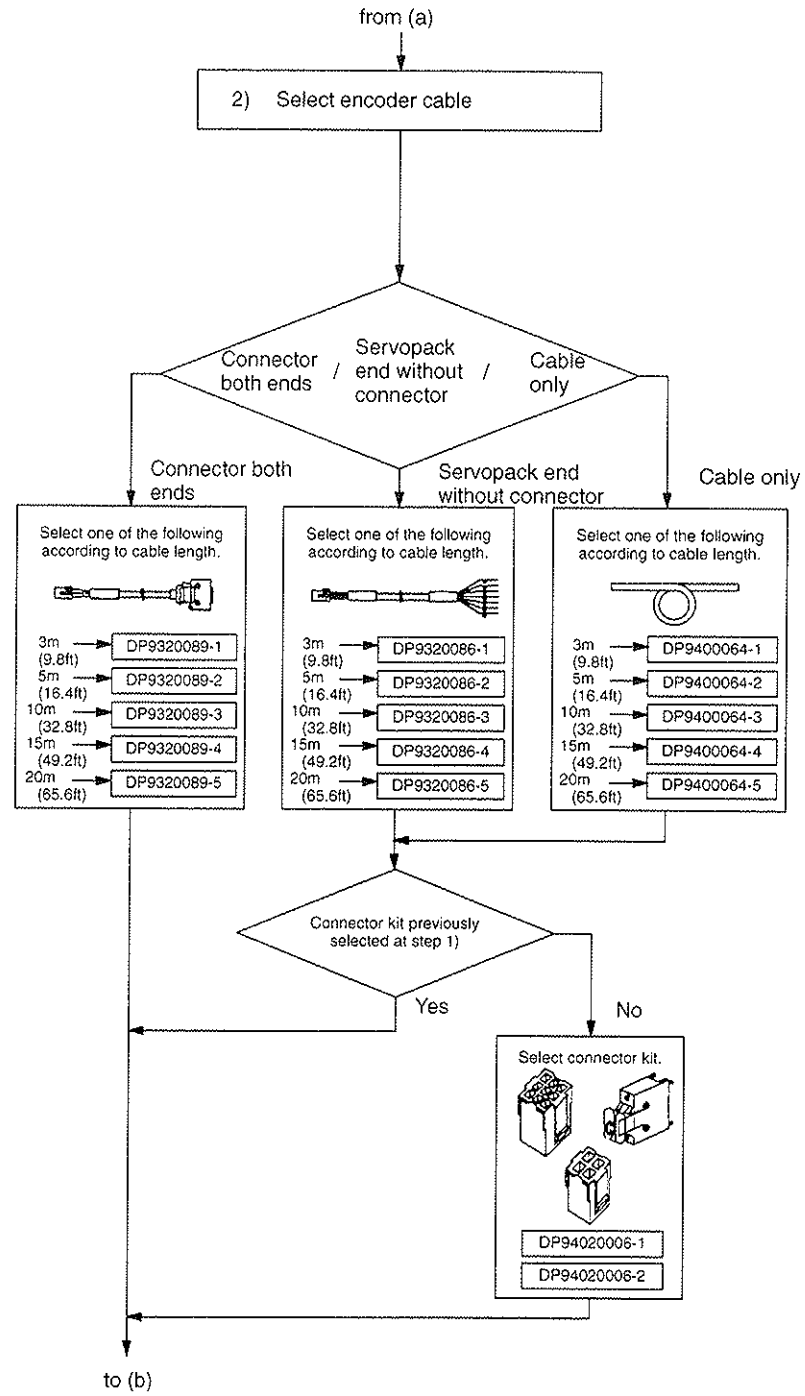

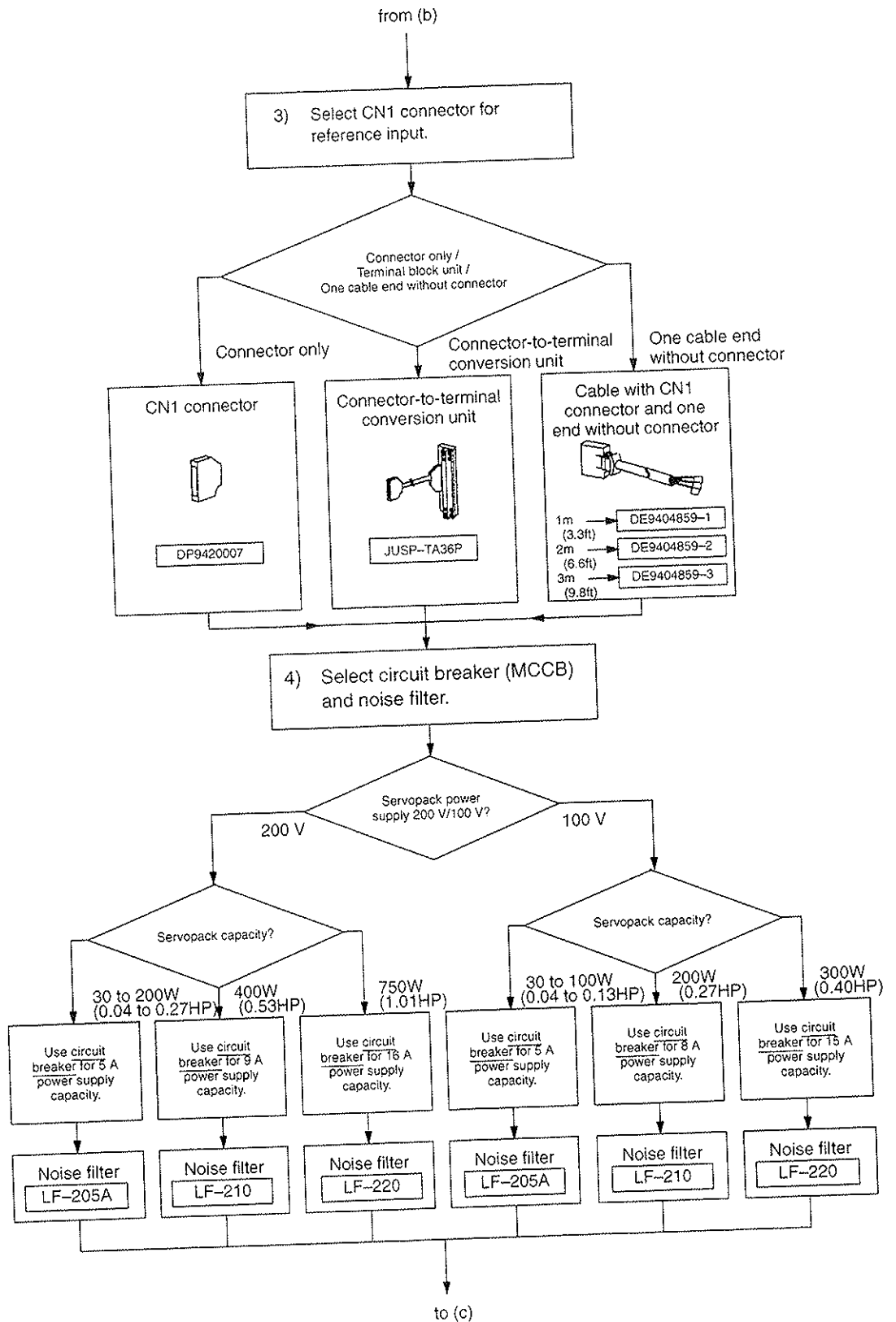

4

# SERVO SELECTION AND DATA SHEETS

## 4.5.1 Selecting Peripheral Devices

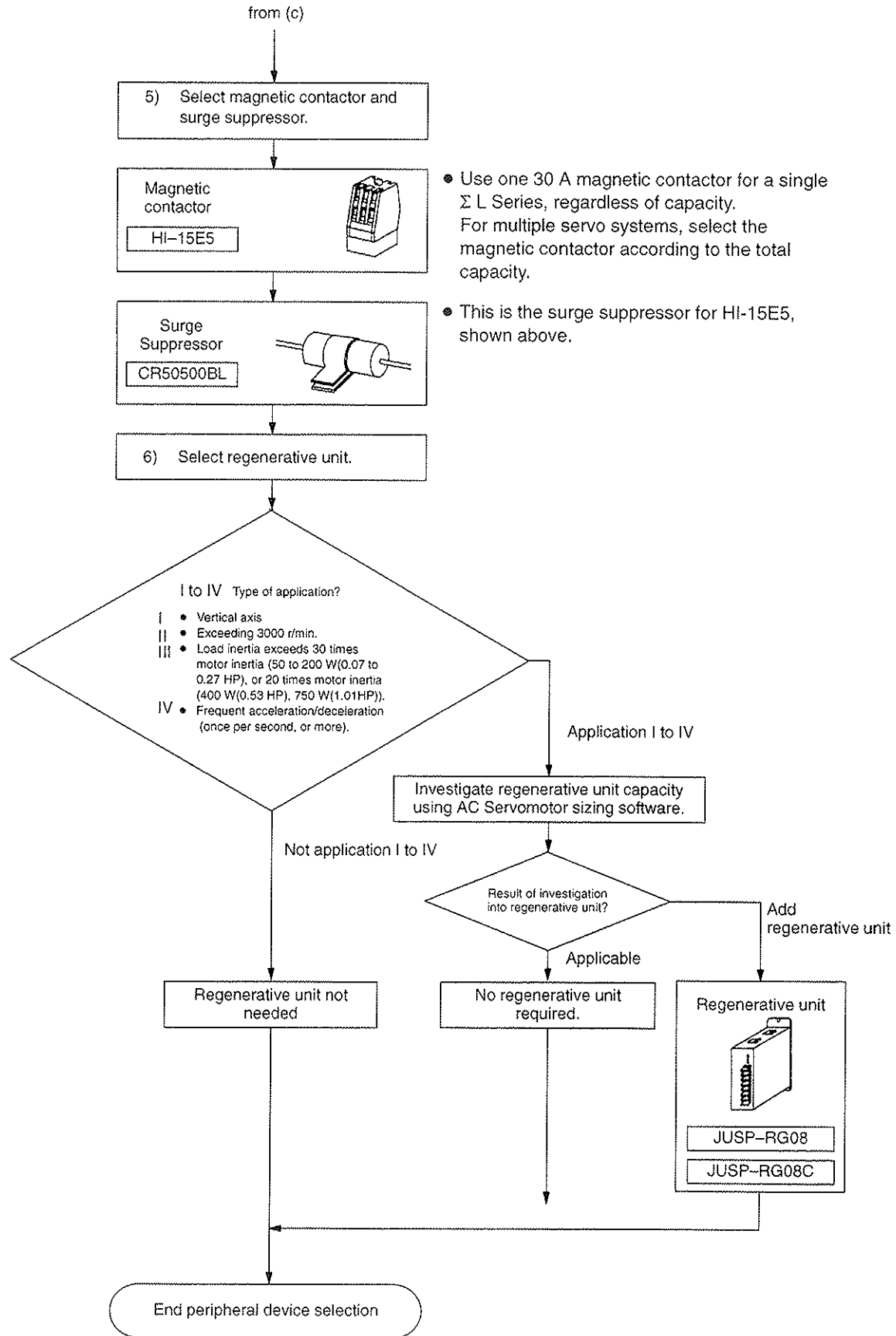

## 4.6 Specifications and Dimensional Drawings of Peripheral Devices

This section shows the specifications and dimensional drawings of the peripheral devices required for the  $\Sigma$ -L Series servo system. The sequence of peripheral devices is given by the Flowchart for Peripheral Device Selection in *4.5 Selecting Peripheral Devices*.

4.6.1	Cable Specifications and Peripheral Devices .....	187
4.6.2	Motor Cables .....	190
4.6.3	Connector Kits .....	193
4.6.4	Brake Power Supply .....	197
4.6.5	Encoder Cables .....	199
4.6.6	CN1 Connector .....	203
4.6.7	Connector Terminal Block Converter Unit .....	205
4.6.8	Cable With CN1 Connector and One End Without Connector .....	207
4.6.9	Circuit Breaker .....	207
4.6.10	Noise Filter .....	208
4.6.11	Magnetic Contactor .....	209
4.6.12	Surge Suppressor .....	210
4.6.13	Regenerative Unit .....	211
4.6.14	Cables for Connecting PC and Servopack .....	213

### 4.6.1 Cable Specifications and Peripheral Devices



1) The rated current of the SGDL Servopack external terminals, cable size, and peripheral devices are listed in the next table.

The cable specifications and size are selected according to the operating environment and current capacity.

The cable specifications were selected under conditions of three cables per bundle at 40° C ambient temperature, with the rated current flowing.

## SERVO SELECTION AND DATA SHEETS

### 4.6.1 Cable Specifications and Peripheral Devices

Type	Servopack Type SGDL-		Main circuit power input terminal (R) (T)		Motor connec- tion terminals (U) (V) (W) $\underline{\underline{G}}$		Power Supply capacity per Servo- pack* <sup>1</sup> kVA	MCCB or fuse ca- pacity* <sup>2</sup> A	Noise filter type (refer- ence dia- gram)	Recom- mended noise filter* <sup>3</sup>		Power ON/OFF switch
			Rated current A(rms)	Cable spec.	Rated current A (rms)	Cable spec.				Type	Spec.	
For 200 V	30 W (0.04HP)	A3AS	1.3	HIV 1.25 min.	0.42	Use Yaskawa cable. See 4.6.2 <i>Motor Cables</i> below for details.	0.25	5	Appli- cable 	LF- 205A	Single- phase 200 VAC Class, 5 A	Yaskawa HI-15E5 (30 A), or equiva- lent
	50 W (0.07HP)	A5AS	1.5		0.6		0.3					
	100 W (0.13HP)	01AS	2.5		0.87		0.5					
	200 W (0.27HP)	02AS	4.0		2.0		0.75					
	400 W (0.53HP)	04AS	6.0	HIV 2.0 min.	2.6	When select- ing non-Yas- kawa cables, check the cable current rating and consider the operating en- vironment.	1.2	9	LF- 210	Single- phase 200 VAC Class, 10 A		
	750 W (1.01HP)	08AS	11.0		4.4		2.2				16	
For 100 V	30 W (0.04HP)	A3BS	2.0	HIV 1.25 min.	0.63	Use cable size AWG22 to AWG18 (0.3 to 0.89 mm <sup>2</sup> ).	0.25	5		LF- 205A	Single- phase 200 VAC Class, 5 A	
	50 W (0.07HP)	A5BS	2.6		0.9		0.3					
	100 W (0.13HP)	01BS	4.5		2.2		0.5					
	200 W (0.27HP)	02BS	8.0	HIV 2.0 min.	2.7		0.75	8		LF- 210	Single- phase 200 VAC Class, 10 A	
	300 W (0.40HP)	03BS	14.0		3.7		1.4			15	LF- 220	VAC Class, 10 A

\*1 Value at rated load.

\*2 Braking characteristics (at 25°C): 200% for 2 s min., 700% for 0.01 s min.

\*3 Yaskawa recommends noise filters manufactured by Tokin Corp. Yaskawa Controls Co., Ltd. can supply these noise filters.



- 2) The types of cable are shown in the table below. Use it in combination with the table above.

Cable Type		Conductor Allowable Temperature °C
Symbol	Name	
PVC	Normal vinyl cable	---
IV	600 V vinyl cable	60
HIV	Temperature-resistant vinyl cable	75

- Note**
- 1) Use cable with 600 V min. withstand voltage for main circuits.
  - 2) Consider allowable current reduction ratio if cables are bundled in PVC or metal ducts.
  - 3) Use temperature-resistant cable under high ambient or panel temperature where normal vinyl cables rapidly deteriorate.
- 3) The appropriate cables for Servopack connectors CN1 and CN2 are shown in the table below.

Control I/O Signal Connector	CN1	Cable	Use twisted-pair cable or twisted-pair shielded cable.
		Applicable Cable	AWG24,26,28,30
		Finished Cable Dimensions	Ø16.0 mm (Ø 0.63 in.)MAX.
PG Signal Connector	CN2	Cable	Use Yaskawa cable. Use twisted-pair shielded cable if Yaskawa cable is not used.
		Applicable Cable	Applicable cable types: AWG24, 26, 28, 30. However, use AWG22 for encoder power supply and FG line. Use AWG26 for other signals. These connections permit wiring distances up to 20 m (65.6 ft).
		Finished Cable Dimensions	Ø11.6(Ø0.46 in.) mm MAX.

- Note** Cable selection conditions: three cables per bundle at 40 °C ambient temperature, with the rated current flowing.

### 4.6.2 Motor Cables

1) The dimensions and appearance of the motor cables are shown below. Specify the cable type when ordering.

a) Cables For Motor Without Brake (with connector and AMP terminals)

Type	L in mm (feet)
DP9320081-1	3000 <sup>+100</sup> <sub>0</sub> (10 <sup>+0.33</sup> <sub>0</sub> )
DP9320081-2	5000 <sup>+100</sup> <sub>0</sub> (16.7 <sup>+0.33</sup> <sub>0</sub> )
DP9320081-3	10000 <sup>+500</sup> <sub>0</sub> (33.3 <sup>+1.67</sup> <sub>0</sub> )
DP9320081-4	15000 <sup>+500</sup> <sub>0</sub> (50 <sup>+1.67</sup> <sub>0</sub> )
DP9320081-5	20000 <sup>+500</sup> <sub>0</sub> (66.7 <sup>+1.67</sup> <sub>0</sub> )

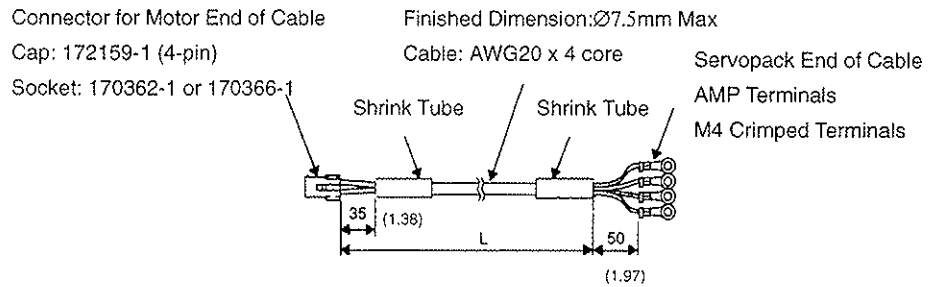

b) Cables For Motor With Brake (with connector and AMP terminals)

Type	L in mm (feet)
DP9320083-1	3000 <sup>+100</sup> <sub>0</sub> (10 <sup>+0.33</sup> <sub>0</sub> )
DP9320083-2	5000 <sup>+100</sup> <sub>0</sub> (16.7 <sup>+0.33</sup> <sub>0</sub> )
DP9320083-3	10000 <sup>+500</sup> <sub>0</sub> (33.3 <sup>+1.67</sup> <sub>0</sub> )
DP9320083-4	15000 <sup>+500</sup> <sub>0</sub> (50 <sup>+1.67</sup> <sub>0</sub> )
DP9320083-5	20000 <sup>+500</sup> <sub>0</sub> (66.7 <sup>+1.67</sup> <sub>0</sub> )

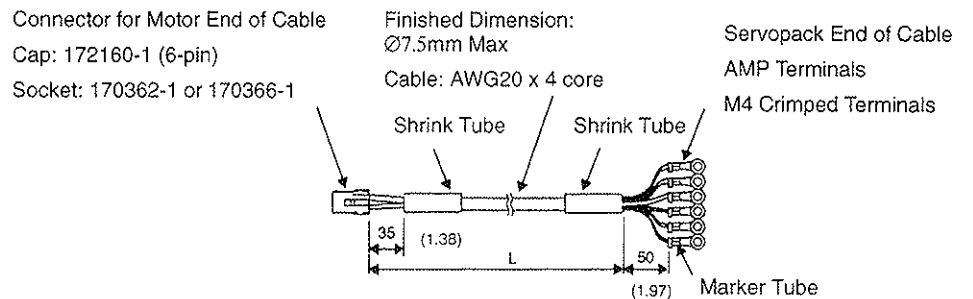

c) Cables For Motor Without Brake  
(Cable Only)

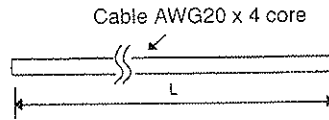

Type	L in mm (feet)	
DP8409359-1	3000 <sup>+100</sup> <sub>0</sub>	(10 <sup>+0.33</sup> <sub>0</sub> )
DP8409359-2	5000 <sup>+100</sup> <sub>0</sub>	(16.7 <sup>+0.33</sup> <sub>0</sub> )
DP8409359-3	10000 <sup>+500</sup> <sub>0</sub>	(33.3 <sup>+1.67</sup> <sub>0</sub> )
DP8409359-4	15000 <sup>+500</sup> <sub>0</sub>	(50 <sup>+1.67</sup> <sub>0</sub> )
DP8409359-5	20000 <sup>+500</sup> <sub>0</sub>	(66.7 <sup>+1.67</sup> <sub>0</sub> )

AMP Connector  
Cap: 172159-1  
Socket: 170362-1 or 170366-1 (Manufactured by AMP.)

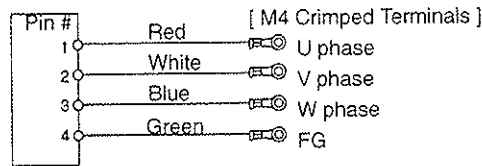

4

## SERVO SELECTION AND DATA SHEETS

### 4.6.2 Motor Cables

#### d) Cables For Motor With Brake (Cable Only)

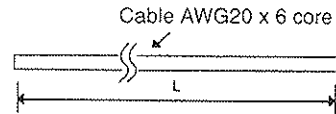

Type	L in mm (feet)
DP8409360-1	3000 <sup>+100</sup> <sub>0</sub> (10 <sup>+0.33</sup> <sub>0</sub> )
DP8409360-2	5000 <sup>+100</sup> <sub>0</sub> (16.7 <sup>+0.33</sup> <sub>0</sub> )
DP8409360-3	10000 <sup>+500</sup> <sub>0</sub> (33.3 <sup>+1.67</sup> <sub>0</sub> )
DP8409360-4	15000 <sup>+500</sup> <sub>0</sub> (50 <sup>+1.67</sup> <sub>0</sub> )
DP8409360-5	20000 <sup>+500</sup> <sub>0</sub> (66.7 <sup>+1.67</sup> <sub>0</sub> )

AMP Connector

Cap: 172160-1

Socket: 170362-1 or 170366-1 (Manufactured by AMP.)

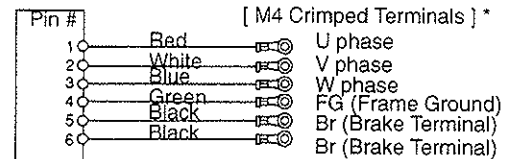

\* If cable only is ordered, purchase the AMP connector and M4 crimped terminals separately. Refer to 4.6.3 *Connector Kits* for details about caps and sockets.

### 4.6.3 Connector Kits

- 1) A connector kit comprises three connectors as shown in the diagram below: one encoder connector at both the motor and Servopack ends of the cable and a motor connector for the motor end of the cable.

Encoder Connector for Motor End of Cable

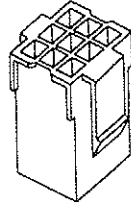

Encoder Connector for Servopack End of Cable

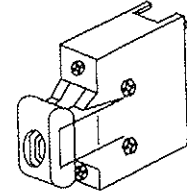

Motor Connector for Motor End of Cable

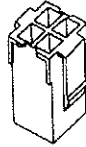

Two types of connector kit are available according to the following information:

- Is the motor with or without a brake?

A connector kit is required in the following cases:

- If motor cable only is purchased (whether or not motor has a brake).
- If the encoder cable with a motor connector only and Servopack end without connector, or encoder cable only is purchased.

- 2) Select the following encoder cable connector.

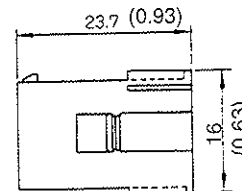
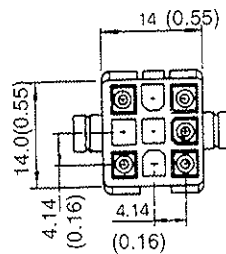

Cap: 172161-1

Socket: 170365-1

3) Select one of the following two types of motor cable connector.

a) Motor Without Brake

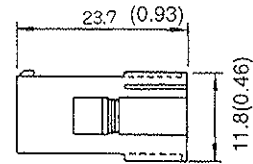
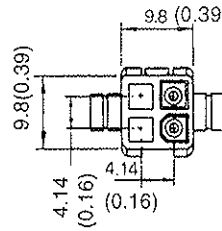

Cap: 172159-1

Socket: 170362-1 or 170366-1

b) Motor With Brake

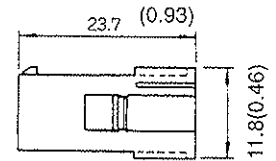
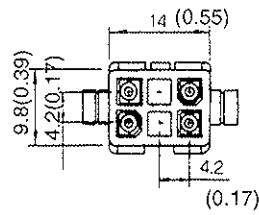

Cap: 172160-1

Socket: 170362-1 or 170366-1

4) Only one type of encoder connector is available for the Servopack end of the cable.

- Connector

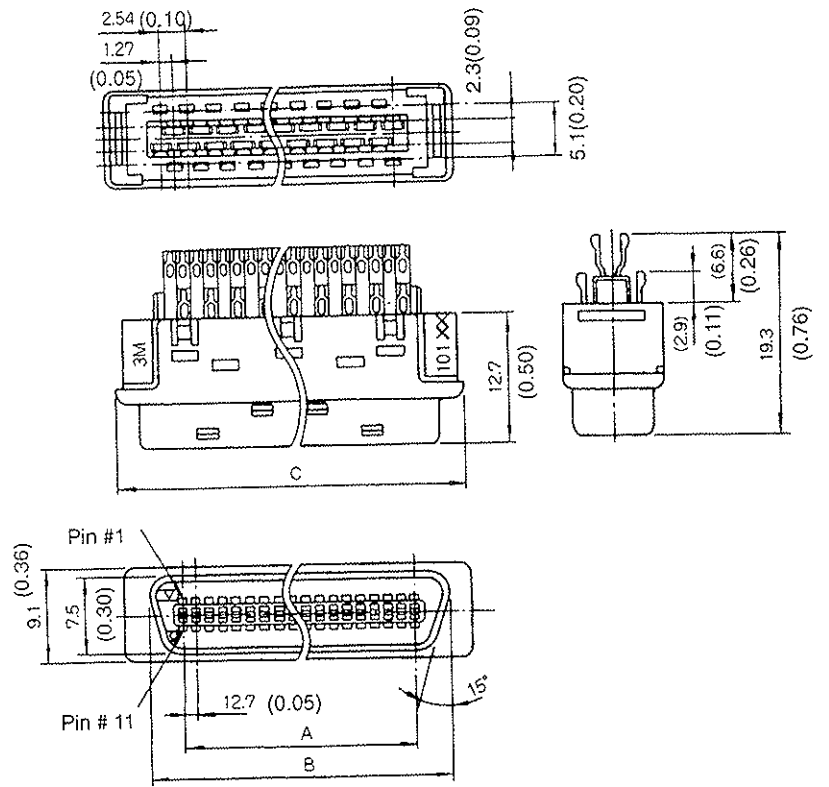

Units: mm (inches)

Connector Type	A	B	C
10120-3000VE	11.43(0.45)	17.6(0.69)	22.0(0.87)

# SERVO SELECTION AND DATA SHEETS

## 4.6.3 Connector Kits

- Case

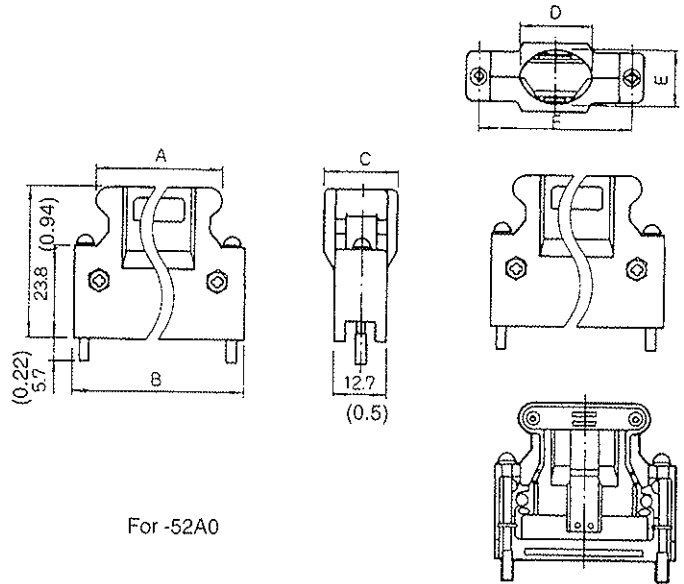

Diagram of Assembled Connector (for reference)

Units: mm (inches)

Connector	Case	A	B	C	D	E	F
10120-3000VE	10320-52A0-008	22.0 (0.87)	18.0 (0.71)	14.0 (0.55)	12.0 (0.47)	10.0 (0.39)	27.4 (1.08)

- 5) The types of connector kit are shown below. Select the type of connector kit according to the connectors selected in (2), (3), and (4) above.

Connector Kit Type	Application		Connector Kit Part List											
			Encoder/Motor Cable		For Encoder Cable						For Motor Cable			
	Encoder Type	Motor Brake With/Without	Encoder End				Servopack End		Cap		Socket			
			Cap	Socket			Connector		Case		Type	Qty	Type	Qty
Type	Qty	Type	Qty	Type	Qty	Type	Qty	Type	Qty	Type	Qty	Type	Qty	
DP9420006-1	Incremental	Without	*1 172161 -1	1	*1 170365 -1	*3 10	*2 10120-3000VE	1	*2 10320-52A0-008	1	*1 172159 -1	1	*1 170366 -1	*3 5
DP9420006-2	Incremental	With									*1 172160 -1	1		*3 7

\*1 Manufactured by AMP.

\*2 Manufactured by 3M.

\*3 Including one spare.



### 4.6.4 Brake Power Supply

1) Brake power supplies are available for 200 V and 100 V input.

200 VAC Input: LPSE-2H01  
 100 VAC Input: LPDE-1H01

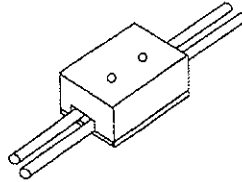

Use for Servomotor with brake.

• Dimensional Drawings

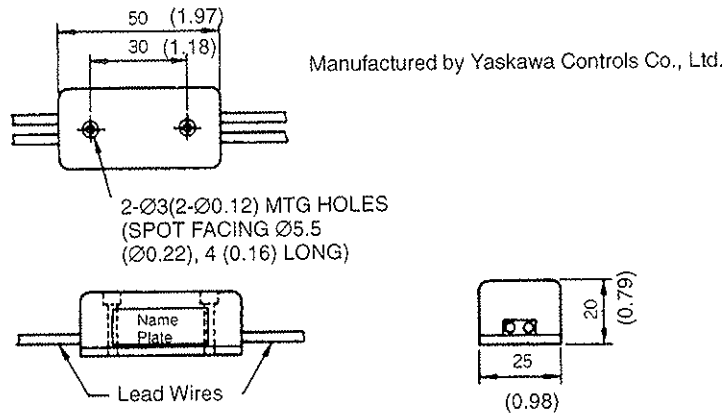

- Lead Wire Length: 500 mm each (19.69 in.)
- Max. Ambient Temperature: 60°C
- Lead Wires: Color Coded

AC Input		Brake
100V	200V	
Blue/White	Yellow/White	Red/Black

## SERVO SELECTION AND DATA SHEETS

### 4.6.4 Brake Power Supply

2) The internal circuits are shown below. While it is possible to switch either the AC or DC side of the brake power supply, it is normally safer to switch the AC side. If the DC side is to be switched, install a surge suppressor near the brake coil to prevent the surge voltages due to switching the DC side damaging the brake coil.

- Internal Circuit for 200 VAC Input (LPSE-2H01)

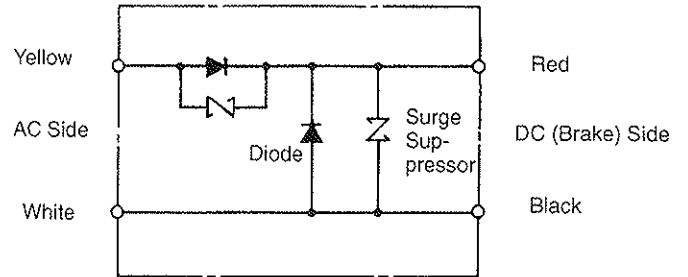

- Internal Circuit for 100 VAC Input (LPDE-1H01)

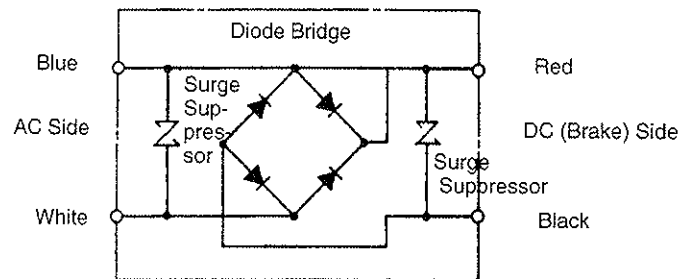

### 4.6.5 Encoder Cables

1) The dimensions and appearance of the encoder cables are shown below. Specify the cable type when ordering.

a) Connector Both Ends

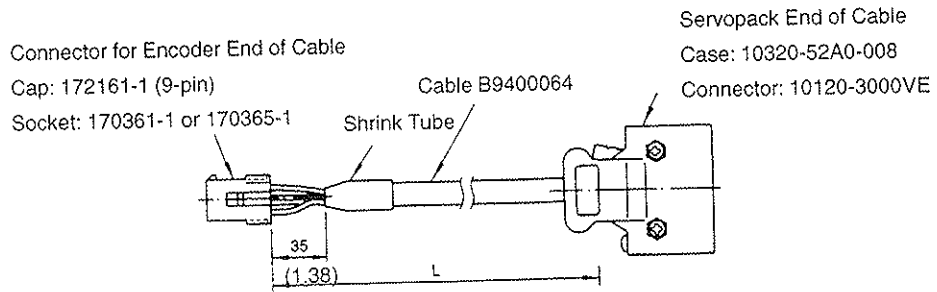

Type	L in mm (feet)
DP9320089-1	$3000^{+100}_0$ ( $10^{+0.33}_0$ )
DP9320089-2	$5000^{+100}_0$ ( $16.7^{+0.33}_0$ )
DP9320089-3	$10000^{+500}_0$ ( $33.3^{+1.67}_0$ )
DP9320089-4	$15000^{+500}_0$ ( $50^{+1.67}_0$ )
DP9320089-5	$20000^{+500}_0$ ( $66.7^{+1.67}_0$ )

4

# SERVO SELECTION AND DATA SHEETS

## 4.6.5 Encoder Cables

### b) Servopack End without Connector

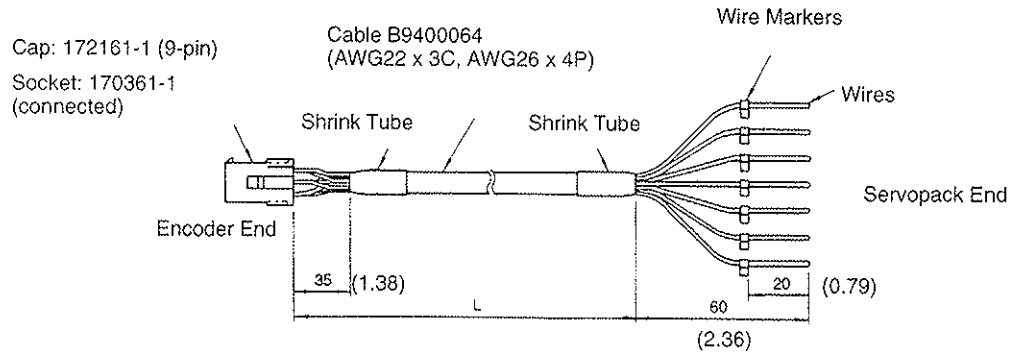

Type	L in mm (feet)
DP9320086-1	3000 <sup>+100</sup> <sub>0</sub> (10 <sup>+0.33</sup> <sub>0</sub> )
DP9320086-2	5000 <sup>+100</sup> <sub>0</sub> (16.7 <sup>+0.33</sup> <sub>0</sub> )
DP9320086-3	10000 <sup>+500</sup> <sub>0</sub> (33.3 <sup>+1.67</sup> <sub>0</sub> )
DP9320086-4	15000 <sup>+500</sup> <sub>0</sub> (50 <sup>+1.67</sup> <sub>0</sub> )
DP9320086-5	20000 <sup>+500</sup> <sub>0</sub> (66.7 <sup>+1.67</sup> <sub>0</sub> )

Case: 10320-52A0-008 (Manufactured by 3M.)  
 Connector: 10120-3000VE (Manufactured by 3M.)

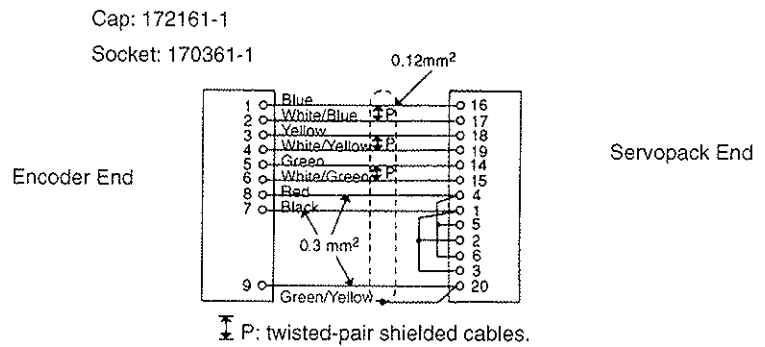

\*Purchase cases and connectors separately. Refer to 4.6.3 Connector Kits for details.

c) Cable Only

Cable AWG22 x 3C, AWG26 x 4P

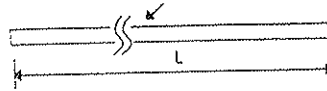

Type	L in mm (feet)	
B9400064-1	3000 <sup>+100</sup> <sub>0</sub>	(10 <sup>+0.33</sup> <sub>0</sub> )
B9400064-2	5000 <sup>+100</sup> <sub>0</sub>	(16.7 <sup>+0.33</sup> <sub>0</sub> )
B9400064-3	10000 <sup>+500</sup> <sub>0</sub>	(33.3 <sup>+1.67</sup> <sub>0</sub> )
B9400064-4	15000 <sup>+500</sup> <sub>0</sub>	(50 <sup>+1.67</sup> <sub>0</sub> )
B9400064-5	20000 <sup>+500</sup> <sub>0</sub>	(66.7 <sup>+1.67</sup> <sub>0</sub> )

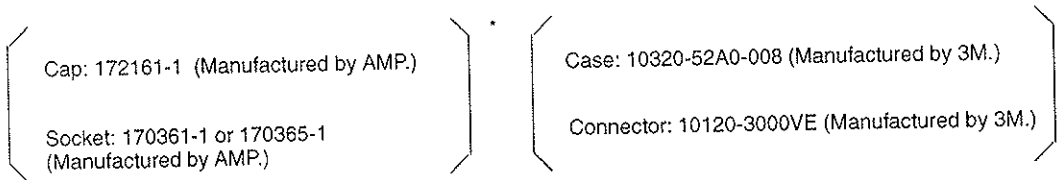

4

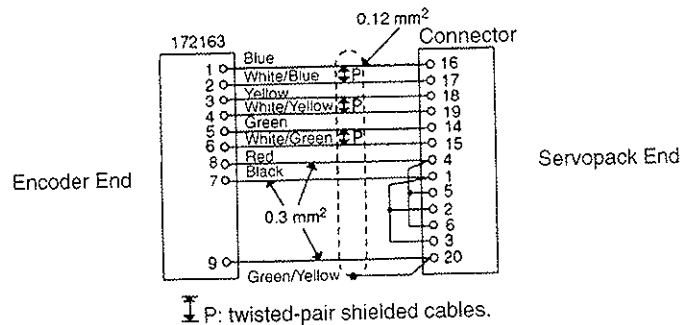

\* Purchase caps, sockets, cases, and connectors separately. Refer to 4.6.3. Connector Kits for details.

## SERVO SELECTION AND DATA SHEETS

### 4.6.5 Encoder Cables

- 2) Details of the encoder cables are summarized in the table below. These cables are not supplied as accessories with a Servopack or Servomotor. Purchase in standard specified lengths as required.

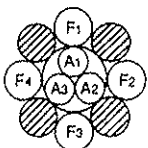
Cable Specification	Incremental Encoder (Yaskawa Drg. #B9400064)
Basic Specifications	Compound KQVV-SW AWG22 x 3C, AWG26 x 4P
Finished Dimension	Ø7.5 mm (Ø0.30 in.)
Internal Structure and Lead Colors	 <p>                     A<sub>1</sub> Red                      A<sub>2</sub> Black                      A<sub>3</sub> Green/Yellow                      F<sub>1</sub> Blue – White/Blue (Twisted pair)                      F<sub>2</sub> Yellow – White/Yellow (Twisted pair)                      F<sub>3</sub> Green – White/Green (Twisted pair)                      F<sub>4</sub> Orange – White/Orange (Twisted pair)                 </p>
Yaskawa standard specifications	Standard lengths: 3 m (9.8ft.), 5 m (16.4ft.), 10 m (32.8ft.), 15 m (49.2ft.), 20 m (65.6ft.) *

\*When appropriate cable is used, the allowable wiring distance between Servopack and Servomotor (PG) is 20 m (65.6ft.) max.

**Note** See items a) and b) in this section for details about cables with connectors.

### 4.6.6 CN1 Connector

1) This connector is required to connect the host controller to CN1 on the Servopack.

- Connector

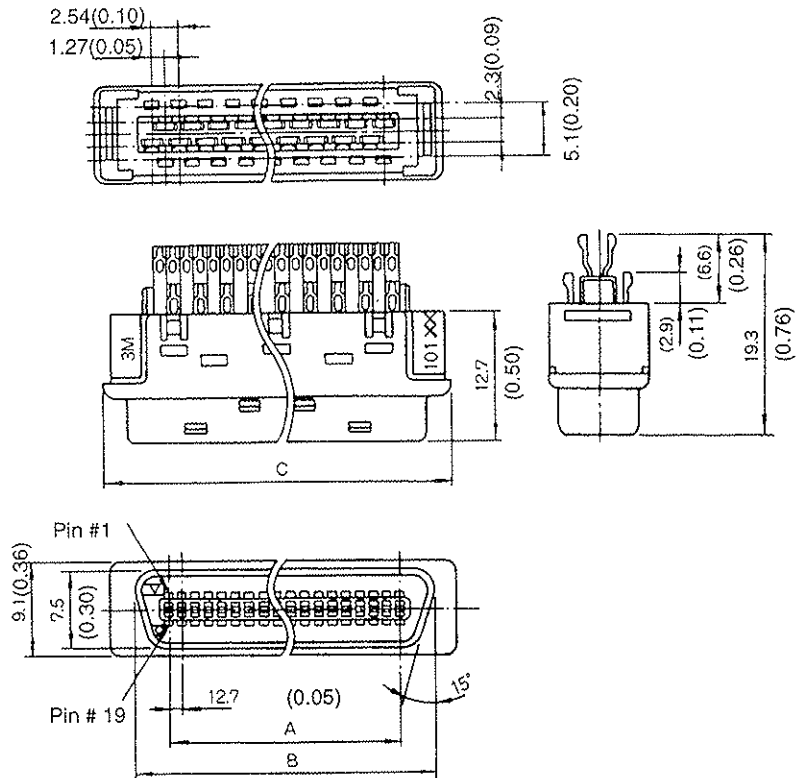

Units: mm (inches)

Connector Type	A	B	C
10136-3000VE	21.59 (0.85)	27.8 (1.09)	32.2 (1.27)

4.6.6 CN1 Connector

- Case

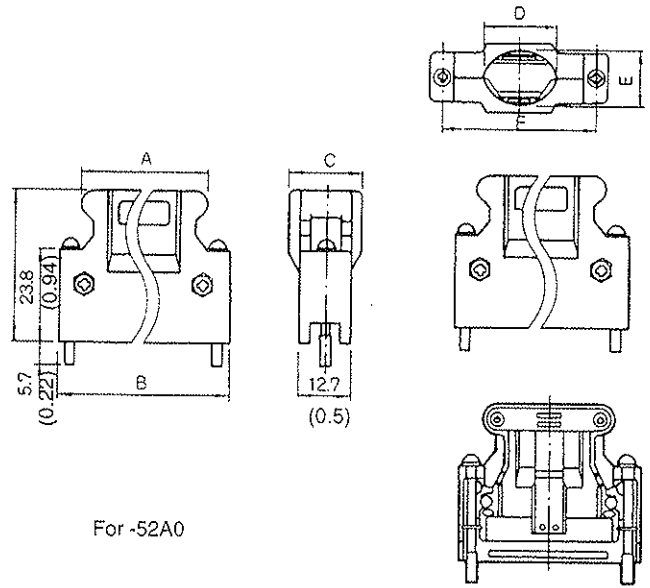

Diagram of Assembled Connector (for reference)

Units: mm (inches)

Connect or Type	Case Type	A	B	C	D	E	F
10136-3000VE	10336-52 A0-008	32.2 (1.27)	43.5 (1.71)	18.0 (0.71)	17.0 (0.67)	14.0 (0.55)	37.6 (1.48)

2) The CN1 connector type is shown below.

Connector Type	Application	Connector Part List			
		Connector		Case	
		Type	Qty	Type	Qty
DP9420007	I/O connector for CN1	10136-3000V E*	1	10336-52A0-008*	1

\* Manufactured by 3M.



### 4.6.7 Connector Terminal Block Converter Unit

- 1) A connector terminal block converter unit comprises a CN1 connector 0.5 m (1.64 ft) cable.  
The terminal block numbers match the Servopack CN1 connector numbers.

- Connector Terminal Block Converter Unit Type: JUSP-TA36P

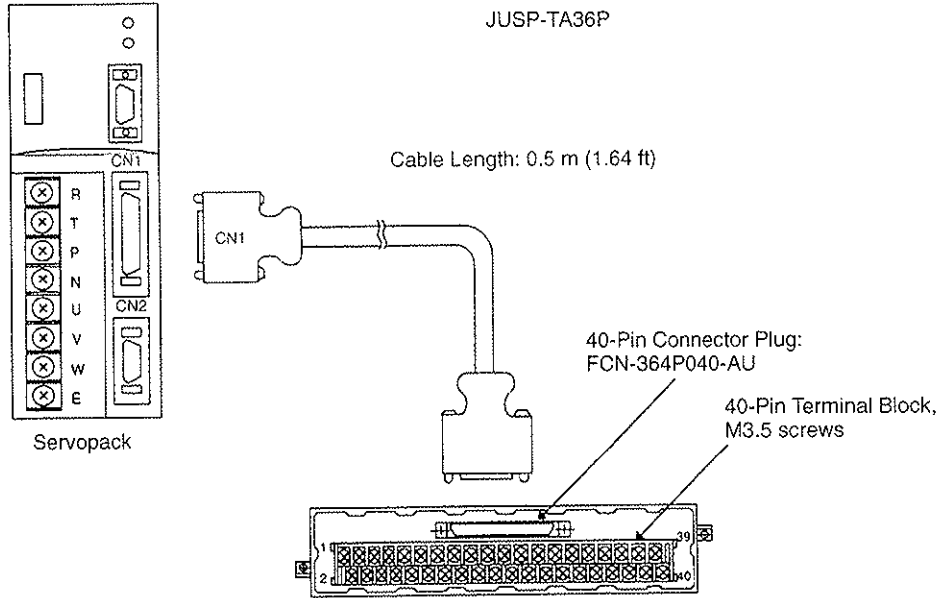

# SERVO SELECTION AND DATA SHEETS

## 4.6.7 Connector Terminal Block Converter Unit

2) The relationships between terminal block pin numbers and signal names are shown in the table below.

SGDL Servopack		JUSP-TA36P Terminal Block Unit		
Signal Name	1CN Pin #		Connector #	Terminal Block #
T-REF	1		A1	1
SG-T	2		B1	2
V-REF	3		A2	3
SG-V	4		B2	4
	5		A3	5
	6		B3	6
$\overline{\text{BK}}$	7		A4	7
	8		B4	8
$\overline{\text{TGON}}$	9		A5	9
SG-COM	10		B5	10
$\overline{\text{P-CL}}$	11		A6	11
$\overline{\text{N-CL}}$	12		B6	12
P-IN	13		A7	13
$\overline{\text{S-ON}}$	14		B7	14
$\overline{\text{P-CON}}$	15		A8	15
P-OT	16		B8	16
N-OT	17		A9	17
$\overline{\text{ALMRST}}$	18		B9	18
SG-PG	19		A10	19
PAO	20		B10	20
*PAO	21	↕ P	A11	21
PBO	22		B11	22
*PBO	23	↕ P	A12	23
PCO	24		B12	24
*PCO	25	↕ P	A13	25
	26		B13	26
	27	↕ P	A14	27
	28		B14	28
	29	↕ P	A15	29
ALO1	30		B15	30
ALO2	31		A16	31
ALO3	32		B16	32
SG-AL	33		A17	33
ALM	34		B17	34
ALM-SG	35	↕ P	A18	35
FG	36		B18	36
Connector Case			A19	37
			B19	38
			A20	39
			B20	40

Cable: Supplied with terminal block

↕ P : Twisted pair

### 4.6.8 Cable With CN1 Connector and One End Without Connector

- 1) Use a cable with no connector at the host controller end. The loose wires are marked with labels with terminal numbers indicated.

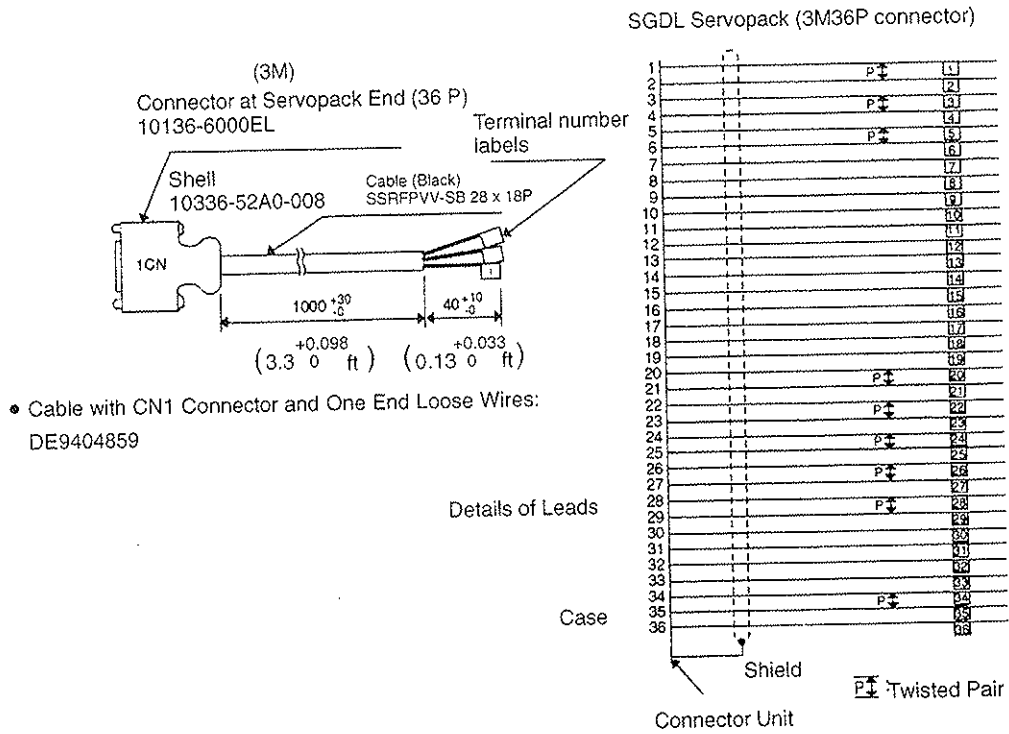

- Cable with CN1 Connector and One End Loose Wires:  
DE9404859

### 4.6.9 Circuit Breaker

- 1) The customer should purchase a circuit breaker (MCCB) of appropriate capacity.

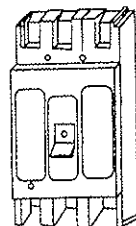

- Recommended Product

Ground fault detector for motor protection manufactured by Mitsubishi Electric Co. Ltd.  
Type: MN50-CF  
Rated Current: 7.1 A, 10 A, 16 A, 25 A, 32 A, 45A

Use to protect the power lines.

### 4.6.10 Noise Filter

1) Select the noise filter from the following three types according to the Servopack capacity.

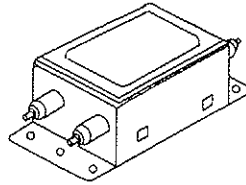

Install to eliminate external noise from the power lines.

Servopack Capacity	Noise Filter Type
30W(0.04 HP), 50W(0.07HP), 100W(0.13HP), 200W(0.27HP)	LF-205A
200W(0.27HP)(100V), 400W(0.53HP)	LF-210
300W(0.40HP)(100V), 750W(1.01HP)	LF-220

• Dimensional Diagrams

- LF-205A (Single-phase 200 VAC Class, 5 A)

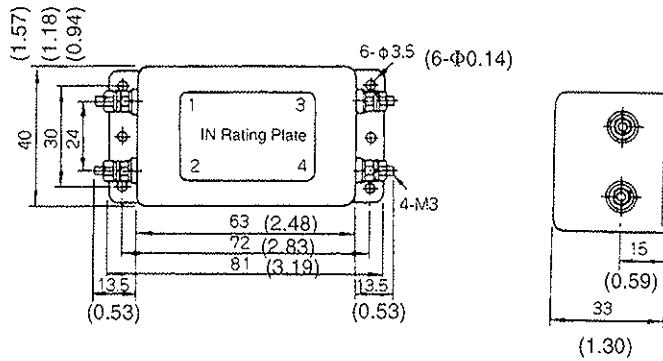

- LF-210 (Single-phase 200 VAC Class, 10 A)

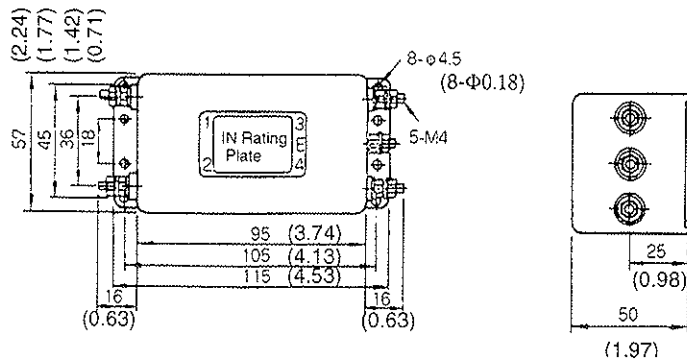

- LF-220 (Single-phase 200 VAC Class, 20 A)

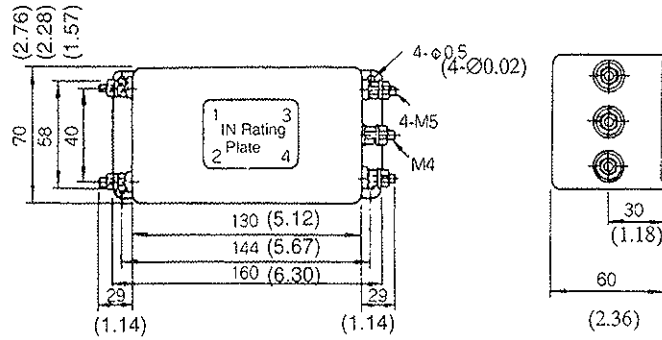

### 4.6.11 Magnetic Contactor

- 1) Use one 30 A magnetic contactor of the type shown below for a single  $\Sigma$ -L Series, regardless of capacity. For multiple servo systems, select the magnetic contactor according to the total capacity.

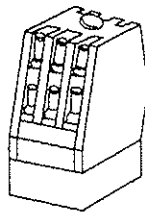

Type: HI-15E5 (30 A)

Turns servo ON and OFF.

(Note) Attach an appropriate surge suppressor to the magnetic contactor.

- Internal Connection Diagram

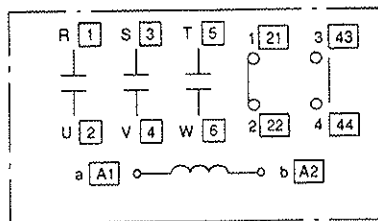

4.6.12 Surge Suppressor

• Dimensional Diagram

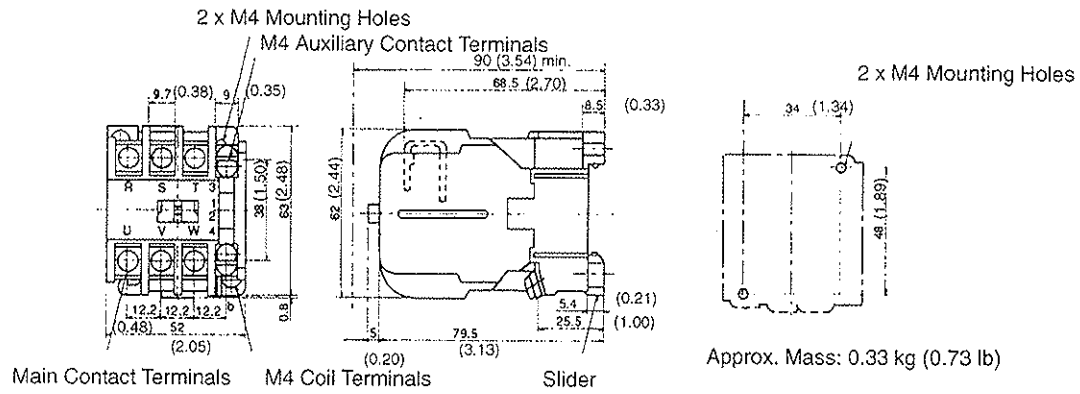

4.6.12 Surge Suppressor

- 1) Attach a surge suppressor to the magnetic contactor to prevent power supply noise and protect contacts.

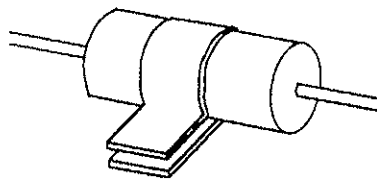

• Recommended Product

Spark Killer manufactured by Okaya Electric Industries Co., Ltd.  
 Type: CR50500BA (250 VAC)  
 Static Electricity Capacity: 0.5  $\mu$ F  $\pm$  20%  
 Resistance: 50  $\Omega$  (1/2 W)  $\pm$  30%

### 4.6.13 Regenerative Unit

1) JUSP-RG08 type

Dimensional drawings of the regenerative unit are shown below.

• Dimensional Drawings

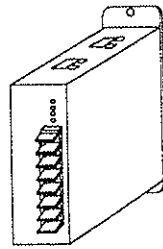

Approx. Mass: 1 kg (2.20 lb)

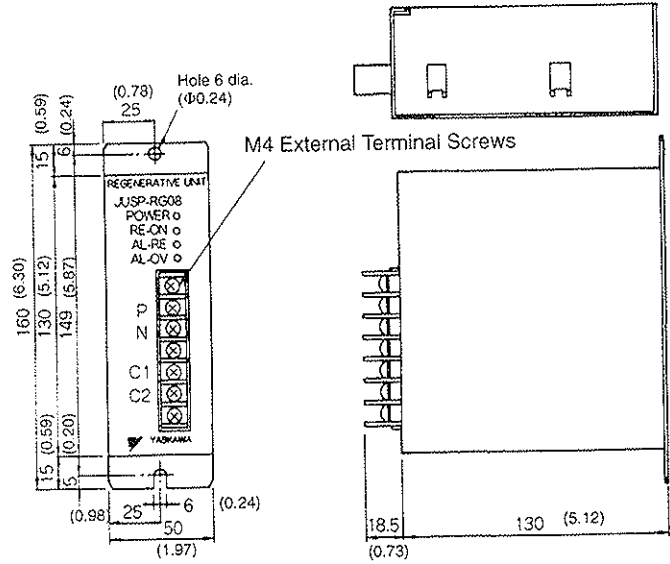

2) JUSP-RG08C type

JUSP-RG08C type is an exterior type regenerative unit. When regenerative ability of the built-in resistor is insufficient, install this regenerative unit to enhance the regenerative ability.

• Dimensional Drawings

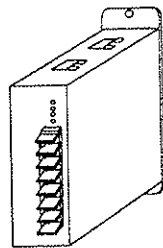

Approx. Mass: 1 kg (2.20 lb)

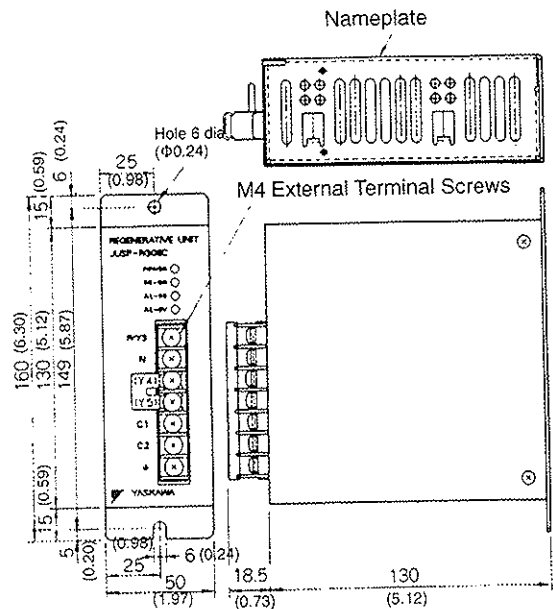

## SERVO SELECTION AND DATA SHEETS

### 4.6.13 Regenerative Unit

- Regenerative Unit Specifications

Type	JUSP-RG08 JUSP-RG08C	Remarks
Applicable Servopack	SGDL Servopack	
Regenerative Working Voltage	380Vdc	
Regenerative Processing Current	8Adc	Regenerative Resistance: 50 $\Omega$ , 60 W
Error Detection Function	Regenerative resistance disconnection, regenerative TR fault, overvoltage	
Alarm Output	Normally closed contact (open when protective function operates)	200 V operation OK
Dimensions    in mm (inches)	55W $\times$ 160H $\times$ 130D (2.17W $\times$ 6.30H $\times$ 5.31D)	



### 4.6.14 Cables for Connecting PC and Servopack

- 1) Special cables for connecting a PC to a Servopack. Using these cables allows monitoring and setting of user constants with a PC.  
PC software is available for these communications. Ask your Yaskawa representative for details. Operate the software as described in the manual supplied.

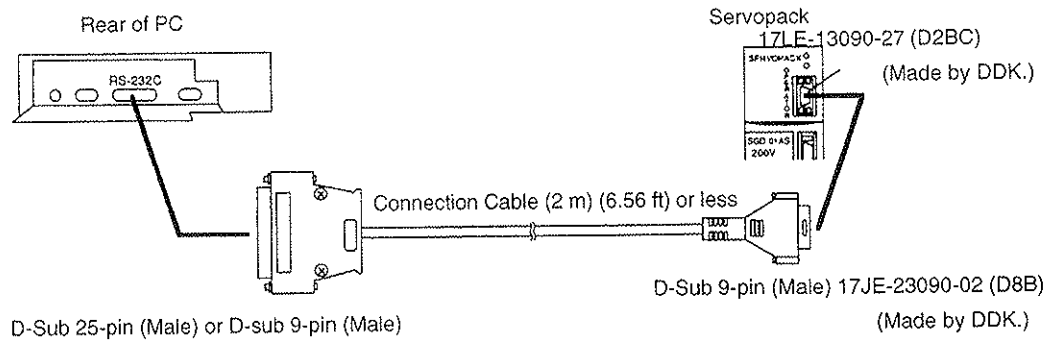

- Dimensional Drawings for Type DE9405258 (for NEC PC)

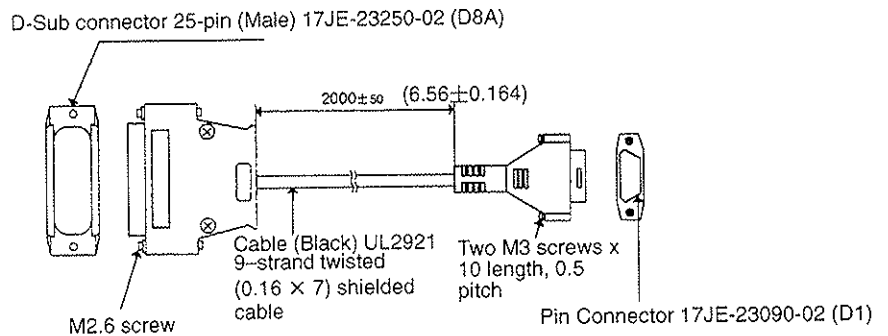

Note: Fold back the cable shielding at each end of the cable and secure it with clamps.

- 2) The communications specifications and connecting-circuit specifications are listed below.

- Baud Rate: 9600 bps
- Number of Bits
  - Start: 1 bit
  - Data: 7 bits
  - Stop: 1 bit
  - Parity: 1 bit (even)
- Synchronization: Start-Stop
- XON/XOFF Control: None
- Shift Control: None

## SERVO SELECTION AND DATA SHEETS

### 4.6.14 Cables for Connecting PC and Servopack

- Communications Method: Semi-duplex

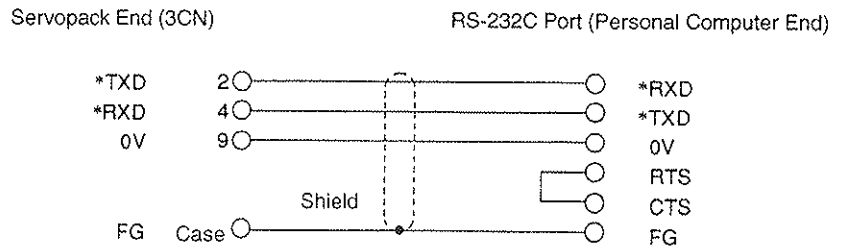

Note: Maximum cable length is 2 m (6.56 ft).

3) Connection is also possible to the RS-422A port. In this case, the connection circuit is as follows:

- Transmission Distance: 30 m (98.4 ft) max.
- Transmission System: RS-422A

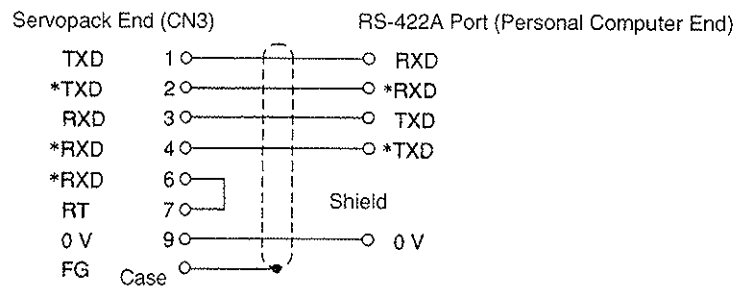

- Terminal Arrangement at Servopack End

Pin #	Signal Name	Signal Circuit Name	Signal Direction
1	TXD	Transmit data (not inverted)	P←S
2	*TXD	Transmit data (inverted)	P←S
3	RXD	Receive data (not inverted)	P→S
4	*RXD	Receive data (inverted)	P→S
5	OPH		#
6	*RXD	Shorting pins 6 and 7 inserts 220 Ω termination resistance between RXD and *RXD.	
7	RT		
8	5VPP		#
9	GND	Signal ground 0 V	

P: Personal computer  
 S: Servopack  
 #: Terminal not used, leave open.

4) Cable for connecting Servopack and IBM PC (IBM compatible PC)

Use Yaskawa DE9408565 type cable.

- Dimensional Drawings: Type DE9408565

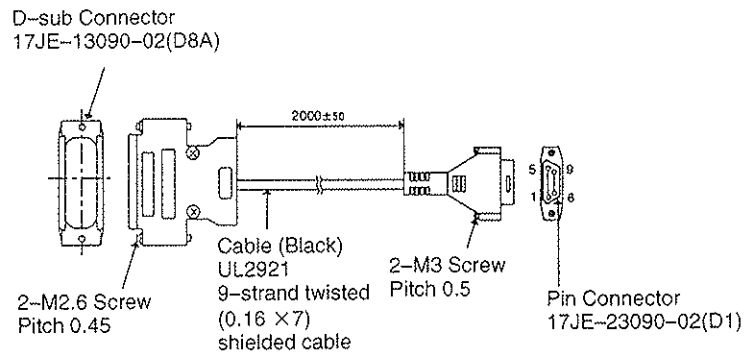

Note: Fold back the cable shielding at each end of the cable and secure it with clamp.

- Connection

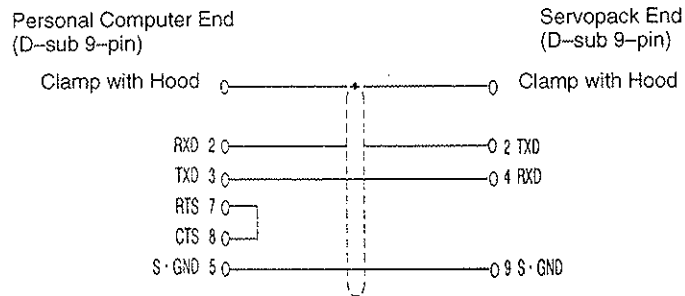

5) Cable for connecting Servopack and NEC PC-98 half-pitch connector

Use Yaskawa DE9408564 type cable.

- Dimensional Drawings: Type DE9408564

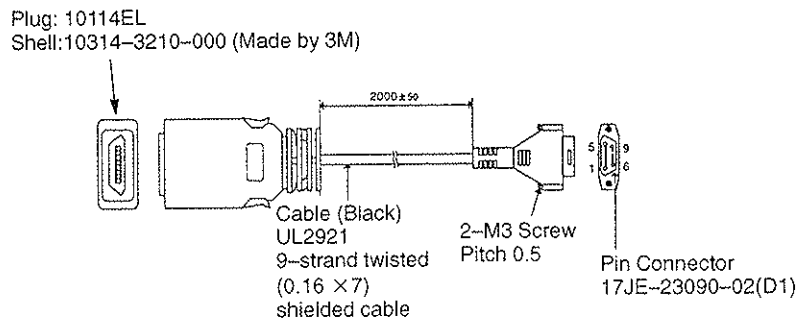

Note: Fold back the cable shielding at each end of the cable and secure it with clamp.

SERVO SELECTION AND DATA SHEETS

4.6.14 Cables for Connecting PC and Servopack

• Connection

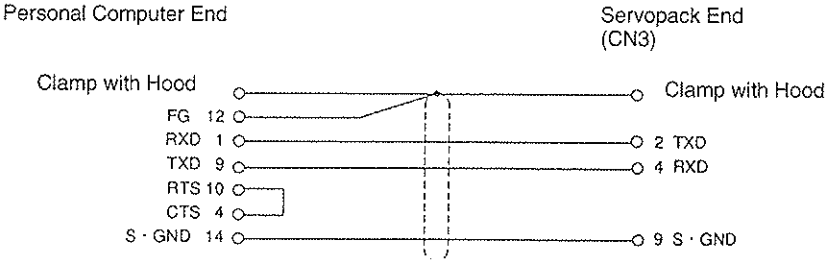

# INSPECTION, MAINTENANCE, AND TROUBLESHOOTING

---

# 5

This chapter describes the basic inspections and maintenance to be carried out by the customer.

In addition, troubleshooting procedures are described for problems which cause an alarm display and for problems which result in no alarm display.

<b>5.1</b>	<b>Inspection and Maintenance</b> .....	<b>218</b>
5.1.1	Servomotor .....	218
5.1.2	Servopack .....	219
<b>5.2</b>	<b>Troubleshooting</b> .....	<b>220</b>
5.2.1	Troubleshooting Problems with Alarm Display .....	220
5.2.2	Troubleshooting Problems With No Alarm Display .....	233
5.2.3	Internal Connection Diagram and Instrument Connection Examples .....	234

## 5.1 Inspection and Maintenance

This section describes the basic inspections and maintenance for  $\Sigma$ -L Series servo drives.

5.1.1	Servomotor .....	218
5.1.2	Servopack .....	219

### 5.1.1 Servomotor

For inspection and maintenance of servomotors, follow the simple, daily inspection procedures in the table below.

The AC servomotors are brushless. Simple, daily inspection is sufficient. The inspection and maintenance frequencies in the table are only guidelines. Determine the frequency to suit the operating conditions and environment.

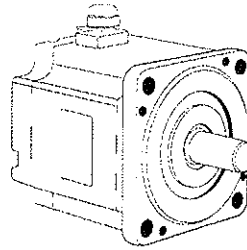

Item	Frequency	Procedure	Comments
Vibration and noise	Daily	Touch and listen.	Levels higher than normal?
Appearance	According to degree of contamination	Clean with cloth or compressed air.	
Insulation resistance measurement	Yearly	Disconnect Servopack and test insulation resistance at 500 V. Must exceed 10 M $\Omega$ . (See note below)	Contact your Yaskawa representative if the insulation resistance is below 10 M $\Omega$ .
Replace oil seal	Every 5,000 hours	Remove servomotor from machine and replace oil seal.	Applies only to motors with oil seal.
Overhaul	Every 20,000 hours or 5 years	Contact your Yaskawa representative.	The customer should not disassemble and clean the servomotor.

**Note** Measure across the servomotor FG (green/yellow) and the U-phase (red), V-phase (white), or W-phase (blue) power lead.

During inspection and maintenance, do not disassemble the servomotor. If disassembly of the servomotor is required, contact your Yaskawa representative.

## 5.1.2 Servopack

For inspection and maintenance of the Servopack, follow the inspection procedures in the table below at least once every year.

The Servopack contains highly reliable parts and daily inspection is not required. Carry out the inspections and maintenance in the table below once every year.

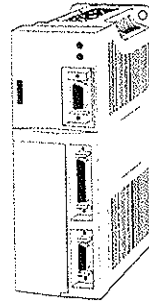

Item	Frequency	Procedure	Remedy
Clean unit interior and circuit boards	Yearly	Check for dust, dirt, and oil on the surfaces.	Clean with compressed air.
Loose screws	Yearly	Check for loose terminal block and connector screws.	Tighten any loose screws.
Defective parts in unit or on circuit boards.	Yearly	Check for discoloration, damage or discontinuities due to heating.	Contact your Yaskawa representative.

### Part Replacement Schedule

The following parts are subject to mechanical wear or deterioration over time. To avoid failure, replace these parts at the frequency indicated.

Part	Standard Replacement Period	Replacement Method
Smoothing Capacitor	7 to 8 years	Test. Replace with new part if necessary.
Relays	---	Test. Replace if necessary.
Fuse	10 years	Replace with new part.

#### Note Operating Conditions:

- Ambient Temperature: annual average 30°C
- Load Factor: 80% max.
- Operation Rate: 20 hours/day max.

## 5.2 Troubleshooting

This section describes causes and remedies for problems which cause an alarm display and for problems which result in no alarm display.

5.2.1	Troubleshooting Problems with Alarm Display .....	220
5.2.2	Troubleshooting Problems With No Alarm Display .....	233
5.2.3	Internal Connection Diagram and Instrument Connection Examples ....	234

### 5.2.1 Troubleshooting Problems with Alarm Display

Refer to the tables below to identify the cause of a problem which causes an alarm display and take the corrective actions described.

Note that A.99 does not indicate an alarm.

Contact your Yaskawa representative if the problem cannot be solved by the described procedures.

#### • Display and Outputs

Digital Operator Display and Alarm Name	Alarm Output			
	Alarm Code Output			Alarm Output
	ALO1	ALO2	ALO3	
<b>A.99</b>	OFF	OFF	OFF	ON

OFF: Output transistor is OFF

ON: Output transistor is ON

#### Status When Alarm Occurred

Indicates normal operation. Not an alarm.



### • Display and Outputs

Digital Operator Display and Alarm Name	Alarm Output			
	Alarm Code Output			Alarm Output
	ALO1	ALO2	ALO3	
<b>A.02</b> User constants breakdown	OFF	OFF	OFF	OFF

OFF: Output transistor is OFF  
ON: Output transistor is ON

### Status When Alarm Occurred



	Cause	Remedy
A	Power turned OFF during parameter write. Alarm occurred next power ON.	Replace Servopack.
B	Circuit board (1PWB) defective	Replace Servopack.

### • Display and Outputs

Digital Operator Display and Alarm Name	Alarm Output			
	Alarm Code Output			Alarm Output
	ALO1	ALO2	ALO3	
<b>A.04</b> User constant setting error	OFF	OFF	OFF	OFF

OFF: Output transistor is OFF  
ON: Output transistor is ON

### Status When Alarm Occurred

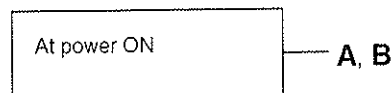

	Cause	Remedy
A	An out-of-range user constant was previously set or loaded.	Reset all user constants in range. Otherwise, re-load correct user constants.
B	Circuit board (1PWB) defective	Replace Servopack.

5.2.1 Troubleshooting Problems with Alarm Display cont.

• Display and Outputs

Digital Operator Display and Alarm Name	Alarm Output			
	Alarm Code Output			Alarm Output
	ALO1	ALO2	ALO3	
<b>A.10</b> Overcurrent	ON	OFF	OFF	OFF

OFF: Output transistor is OFF  
ON: Output transistor is ON

Status When Alarm Occurred

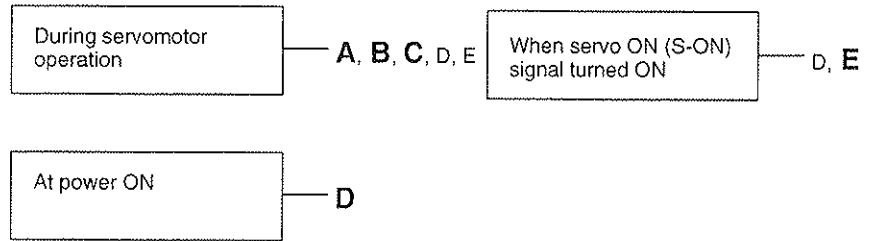

	Cause	Remedy
A	Wiring grounded between Servopack and servomotor.	Check and correct wiring.
B	Servopack ambient temperature exceeds 50°C	Bring Servopack ambient temperature to 50°C <b>Note</b> Alarm cannot be reset while power transistor module temperature exceeds 90°C.
C	Servomotor U, V, or W phase grounded.	Replace servomotor.
D	<ul style="list-style-type: none"> <li>• Circuit board (1PWB) defective</li> <li>• Power transistor defective</li> </ul>	Replace Servopack.
E	Current feedback circuit, power transistor, DB relay, or circuit board defective.	Replace Servopack.

• Display and Outputs

Digital Operator Display and Alarm Name	Alarm Output			Alarm Output
	Alarm Code Output			
	ALO1	ALO2	ALO3	
<b>A.40</b> Overvoltage	OFF	OFF	ON	OFF

OFF: Output transistor is OFF  
ON: Output transistor is ON

Status When Alarm Occurred

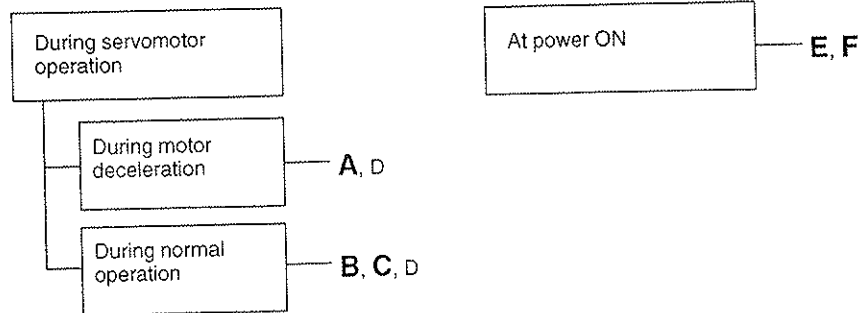

	Cause	Remedy
A	Load inertia high and motor speed too high	<ul style="list-style-type: none"> <li>• Change operating conditions.</li> <li>• Use regenerative unit.</li> <li>• If multiple units are used, connect all P, N terminals in parallel.</li> </ul>
B	Load exceeds capacity of regenerative unit	Change operating conditions.
C	Servomotor speed too high	Reduce motor speed.
D	Servopack defective	Replace Servopack.
E	Input voltage too high	Change input voltage to normal value.
F	Circuit board (1PWB) defective.	Replace Servopack.

5

• Display and Outputs

Digital Operator Display and Alarm Name	Alarm Output			
	Alarm Code Output			Alarm Output
	ALO1	ALO2	ALO3	
<b>A.51</b> Overspeed	ON	OFF	ON	OFF

OFF: Output transistor is OFF  
ON: Output transistor is ON

Status When Alarm Occurred

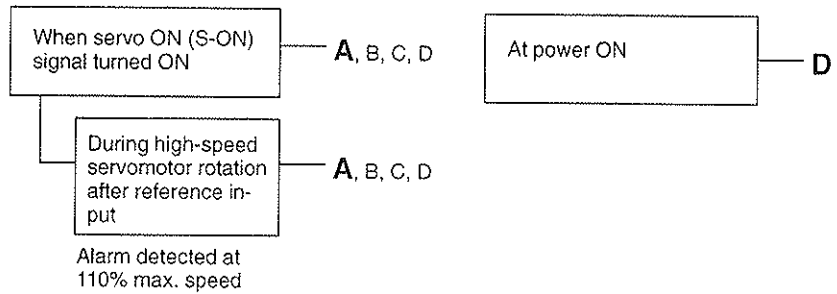

	Cause	Remedy
A	<ul style="list-style-type: none"> <li>• Servomotor wiring incorrect.</li> <li>• Encoder wiring incorrect (disconnection, shortcircuit, power supply, etc.)</li> </ul>	Check and correct wiring. (Check A-, B-, C-phase pulses correct at CN2.)
B	Incremental encoder power not supplied from Servopack.	Use the Servopack power supply for the encoder.
C	Noise in encoder wiring.	Separate encoder wiring from main wiring circuits.
D	Circuit board (1PWB) defective	Replace Servopack.

• Display and Outputs

Digital Operator Display and Alarm Name	Alarm Output			
	Alarm Code Output			Alarm Output
	ALO1	ALO2	ALO3	
<b>A.70</b> Overload	ON	ON	ON	OFF

OFF: Output transistor is OFF  
ON: Output transistor is ON

Status When Alarm Occurred

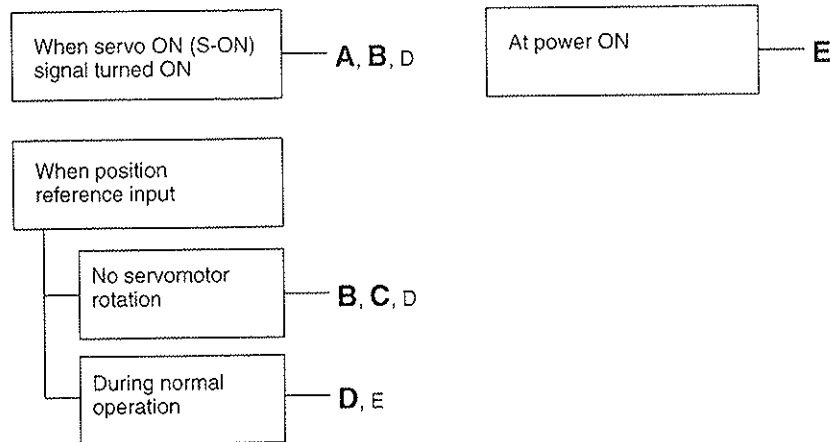

	Cause	Remedy
A	Servomotor wiring incorrect or disconnected	Check wiring and connectors at servomotor.
B	Encoder wiring incorrect or disconnected	Check wiring and connectors at encoder.
C	Load greatly exceeds rated torque	Reduce load torque and inertia. Otherwise, replace with larger capacity servomotor.
D	Incremental encoder power not supplied from Servopack.	Use the Servopack power supply for the encoder.
E	Circuit board (1PWB) defective	Replace Servopack.

5

## INSPECTION, MAINTENANCE AND TROUBLESHOOTING

### 5.2.1 Troubleshooting Problems with Alarm Display cont.

- Display and Outputs

Digital Operator Display and Alarm Name	Alarm Output			
	Alarm Code Output			Alarm Output
	ALO1	ALO2	ALO3	
<b>A.b1</b> Reference input read error (for speed/torque control only)	OFF	OFF	OFF	OFF

OFF: Output transistor is OFF  
ON: Output transistor is ON

#### Status When Alarm Occurred

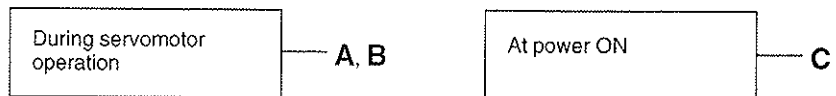

	Cause	Remedy
A	Part malfunctioned in reference read-in unit (A/D converter, etc.).	Reset alarm and restart operation.
B	Part defective in reference read-in unit (A/D converter, etc.).	Replace Servopack.
C	Circuit board (1PWB) defective	Replace Servopack.

• Display and Outputs

Digital Operator Display and Alarm Name	Alarm Output			
	Alarm Code Output			Alarm Output
	ALO1	ALO2	ALO3	
<b>A.C1</b> Servo overrun	ON	OFF	ON	OFF

OFF: Output transistor is OFF  
ON: Output transistor is ON

Status When Alarm Occurred

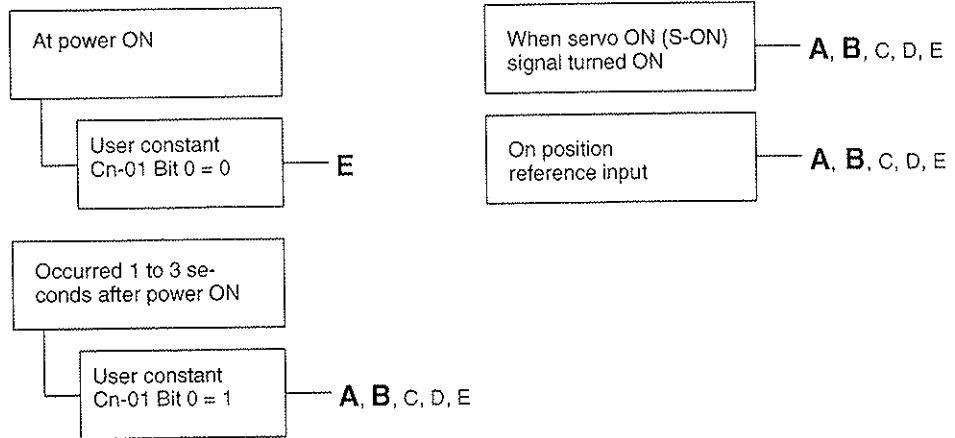

	Cause	Remedy
A	Servomotor wiring incorrect or disconnected	Check wiring and connectors at servomotor.
B	Encoder wiring incorrect or disconnected	Check wiring and connectors at encoder.
C	Incremental encoder power not supplied from Servopack.	Use the Servopack power supply for the encoder.
D	Encoder defective	Replace servomotor.
E	Circuit board (1PWB) defective	Replace Servopack.

5

## INSPECTION, MAINTENANCE AND TROUBLESHOOTING

### 5.2.1 Troubleshooting Problems with Alarm Display cont.

#### • Display and Outputs

Digital Operator Display and Alarm Name	Alarm Output			
	Alarm Code Output			Alarm Output
	ALO1	ALO2	ALO3	
<b>A.C2</b> Encoder phase detection error	ON	OFF	ON	OFF

OFF: Output transistor is OFF  
ON: Output transistor is ON

#### Status When Alarm Occurred

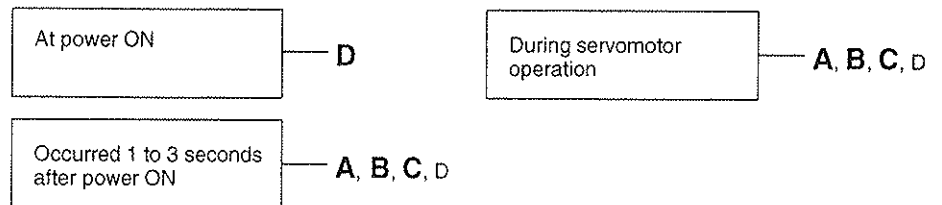

	Cause	Remedy
A	Noise in encoder wiring.	Separate encoder wiring from main wiring circuits.
B	Encoder wiring incorrect or poor connection	Check wiring and connectors at encoder.
C	Encoder defective	Replace servomotor.
D	Circuit board (1PWB) defective	Replace Servopack.

#### • Display and Outputs

Digital Operator Display and Alarm Name	Alarm Output			
	Alarm Code Output			Alarm Output
	ALO1	ALO2	ALO3	
<b>A.C3</b> Encoder A-, B-phase discontinuity	ON	OFF	ON	OFF

OFF: Output transistor is OFF  
ON: Output transistor is ON



Status When Alarm Occurred

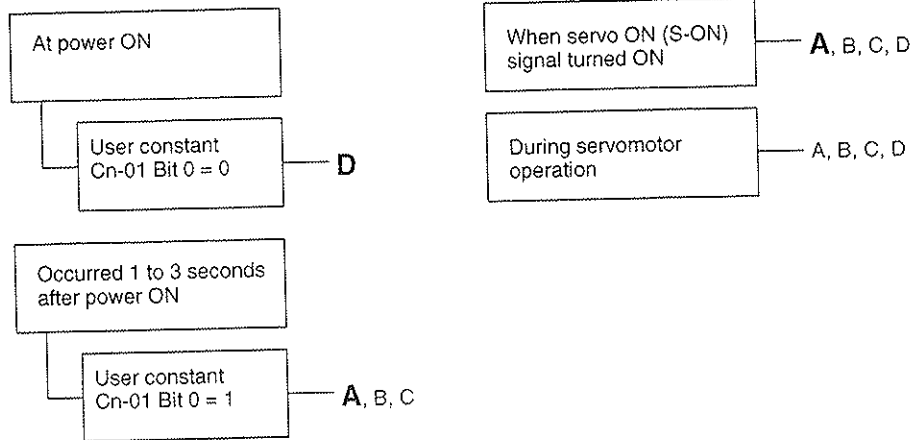

	Cause	Remedy
A	Encoder wiring incorrect or poor connection	Check wiring and connectors at encoder.
B	Noise in encoder wiring.	Separate encoder wiring from main wiring circuits.
C	Encoder defective	Replace servomotor.
D	Circuit board (1PWB) defective	Replace Servopack.

• Display and Outputs

Digital Operator Display and Alarm Name	Alarm Output			
	Alarm Code Output			Alarm Output
	ALO1	ALO2	ALO3	
<b>A.C4</b> Encoder C-phase discontinuity	ON	OFF	ON	OFF

OFF: Output transistor is OFF  
ON: Output transistor is ON

Status When Alarm Occurred

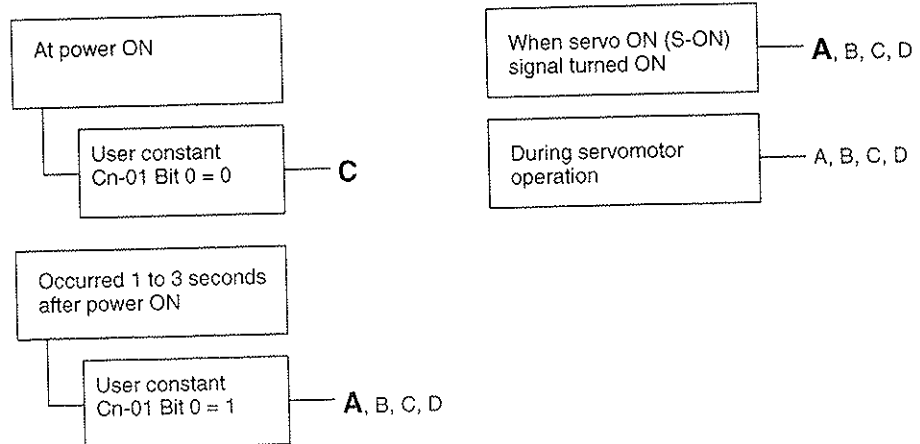

## INSPECTION, MAINTENANCE AND TROUBLESHOOTING

### 5.2.1 Troubleshooting Problems with Alarm Display cont.

	Cause	Remedy
A	Encoder wiring incorrect or poor connection	Check wiring and connectors at encoder.
B	Noise in encoder wiring.	Separate encoder wiring from main wiring circuits.
C	Encoder defective	Replace servomotor.
D	Circuit board (1PWB) defective	Replace Servopack.

• Display and Outputs

Digital Operator Display and Alarm Name	Alarm Output			
	Alarm Code Output			Alarm Output
	ALO1	ALO2	ALO3	
<b>A.F3</b> Power loss error	OFF	ON	OFF	OFF

OFF: Output transistor is OFF  
ON: Output transistor is ON

Status When Alarm Occurred



	Cause	Remedy
A	Time between turning power OFF and back ON was shorter than the power holding time.	After turning power OFF, wait more than the power holding time (6 to 15 s, according to type) before turning the power back ON.
B	If any of the following power supply conditions are met during motor operation: <ul style="list-style-type: none"> <li>• Complete power failure : half cycle of supply frequency</li> <li>• Voltage drop: full cycle of supply frequency</li> </ul> <b>Note</b> Because of detector lag and detector margin, power loss of 30 to 55 ms does not cause an alarm.	Check the power supply. <b>Terms</b> <ul style="list-style-type: none"> <li>• Complete power failure=Power failure where voltage drops to zero.</li> <li>• Voltage drop=Power failure where voltage drops, but not to zero.</li> </ul>

• Display and Outputs

Digital Operator Display and Alarm Name	Alarm Output			
	Alarm Code Output			Alarm Output
	ALO1	ALO2	ALO3	
<b>CPF00</b> Digital operator transmission error 1	Not specified			

**Note** This alarm is not stored in alarm trace-back function memory.

Status When Alarm Occurred

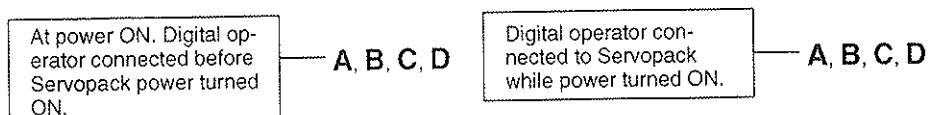

## INSPECTION, MAINTENANCE AND TROUBLESHOOTING

### 5.2.1 Troubleshooting Problems with Alarm Display cont.

	Cause	Remedy
A	Cable defective or poor contact between digital operator and Servopack.	<ul style="list-style-type: none"> <li>• Check connector connections.</li> <li>• Replace cable.</li> </ul>
B	Malfunction due to external noise	Separate digital operator and cable from noise source.
C	Digital operator defective	Replace digital operator.
D	Servopack defective	Replace Servopack.

#### • Display and Outputs

Digital Operator Display and Alarm Name	Alarm Output			Alarm Output
	Alarm Code Output			
	ALO1	ALO2	ALO3	
<b>CPF01</b> Digital operator transmission error 2	Not specified			

**Note** This alarm is not stored in alarm trace-back function memory.

#### Status When Alarm Occurred

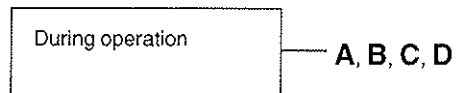

	Cause	Remedy
A	Cable defective or poor contact between digital operator and Servopack.	<ul style="list-style-type: none"> <li>• Check connector connections.</li> <li>• Replace cable.</li> </ul>
B	Malfunction due to external noise	Separate digital operator and cable from noise source.
C	Digital operator defective	Replace digital operator.
D	Servopack defective	Replace Servopack

## 5.2.2 Troubleshooting Problems With No Alarm Display

Refer to the tables below to identify the cause of a problem which causes no alarm display and take the remedy described.

**Turn OFF the servo system power supply before commencing the shaded procedures.**

Contact your Yaskawa representative if the problem cannot be solved by the described procedures.

**Troubleshooting Table No Alarm Display**

Symptom	Cause	Inspection	Corrective Action
Servomotor does not start	Power not connected	Check voltage across R and T.	Correct the power circuit.
	Loose connection	Check terminals of connectors (CN1, CN2).	Tighten any loose parts.
	Connector (CN1) external wiring incorrect	Check connector (CN1) external wiring	Refer to connection diagram and correct wiring.
	Servomotor or encoder wiring disconnected.		Reconnect wiring
	Overloaded	Run under no load.	Reduce load or replace with larger capacity servomotor.
	Speed references not input	Check input pins # 1 to 4 of connector CN1.	Correctly input speed references.
	S-ON is turned OFF	Cn-01 Bit 0 is 0.	Turn S-ON input ON.
	Bit setting of P-CON is incorrect.	Check the bits A and B of user constant Cn-01.	Correct the bit setting.
	Encoder type differs.	1024 P/R incremental encoder?	Use the motor with 1024 P/R incremental encoder.
	P-OT and N-OT inputs are turned OFF.	(If Cn-01 Bits 2, 3 are 0)	Turn P-OT and N-OT input signals ON.
Servomotor moves instantaneously, then stops	Servomotor or encoder wiring incorrect.		Refer to Subsection 2.6.6 and correct wiring.
Suddenly stops during operation and will not restart	Alarm reset signal (ALM-RST) is turned ON because an alarm occurred.		Remove cause of alarm. Turn alarm reset signal (ALM-RST) from ON to OFF.
Servomotor speed unstable	Wiring connection to motor defective	Check connection of power lead (U, V, and W phase) and encoder connectors.	Tighten any loose terminals or connectors.
Servomotor vibrates at approximately 200 to 400 Hz.	Speed loop gain value too high.		Reduce speed loop gain (Cn-04) preset value.
	Reference input lead is bundled with power cables.		Separate reference input lead at least 30 cm from power cables.
High rotation speed overshoot on starting and stopping.	Speed loop gain value too high.		Reduce speed loop gain (Cn-04) preset value.
Servomotor overheated	Ambient temperature too high	Measure servomotor ambient temperature.	Reduce ambient temperature to 40°C max.
	Servomotor surface dirty	Visual check	Clean dust and oil from motor surface.
	Overloaded	Run under no load.	Reduce load or replace with larger capacity servomotor.

# INSPECTION, MAINTENANCE AND TROUBLESHOOTING

## 5.2.3 Internal Connection Diagram and Instrument Connection Examples

Symptom	Cause	Inspection	Corrective Action
Abnormal noise	Mechanical mounting incorrect	Servomotor mounting screws loose?	Tighten mounting screws.
		Coupling not centered?	Center coupling.
		Coupling unbalanced?	Balance coupling.
	Bearing defective	Check noise and vibration near bearing.	Consult your Yaskawa representative if defective.
	Machine causing vibrations	Foreign object intrusion, damage or deformation of sliding parts of machine.	Consult with machine manufacturer.

### 5.2.3 Internal Connection Diagram and Instrument Connection Examples

The SGDL Servopack internal connection diagram and instrument connection examples are given below.

Refer to these diagrams during inspection and maintenance.

#### 1) Internal Connection Diagram

Single-phase 200 to 230 VAC  $\pm 10\%$  /  $-15\%$ , 50/60 Hz  
 or single-phase 100 to 115 VAC  $\pm 10\%$  /  $-15\%$ , 50/60 Hz

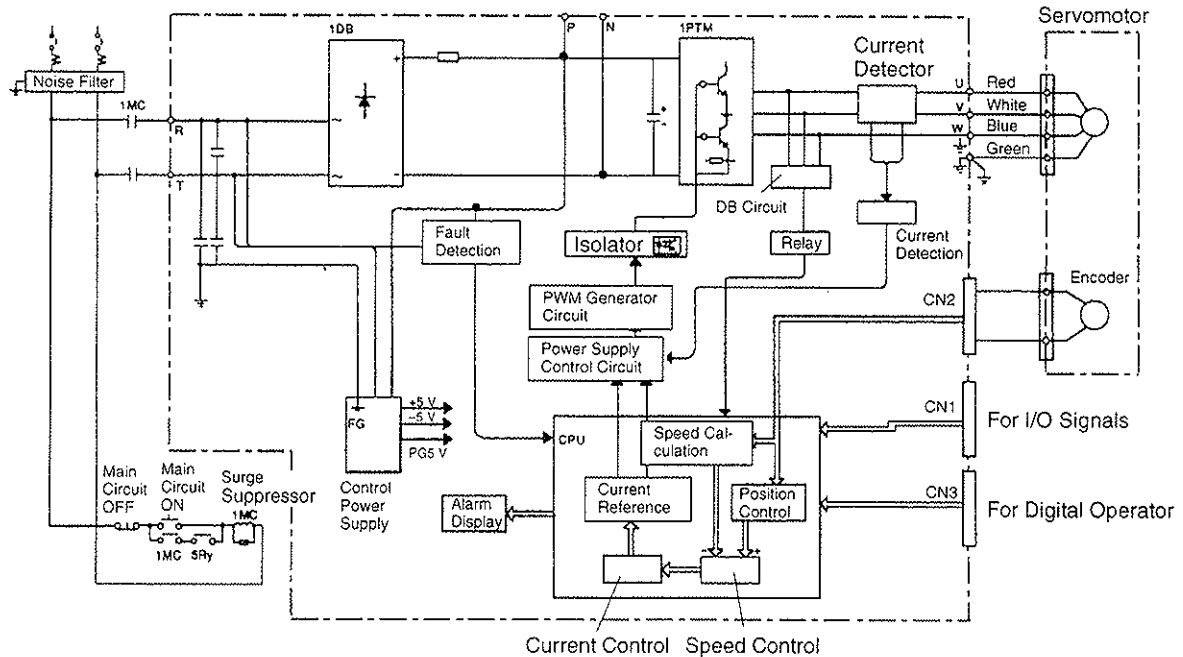

2) Instrument Connection Examples

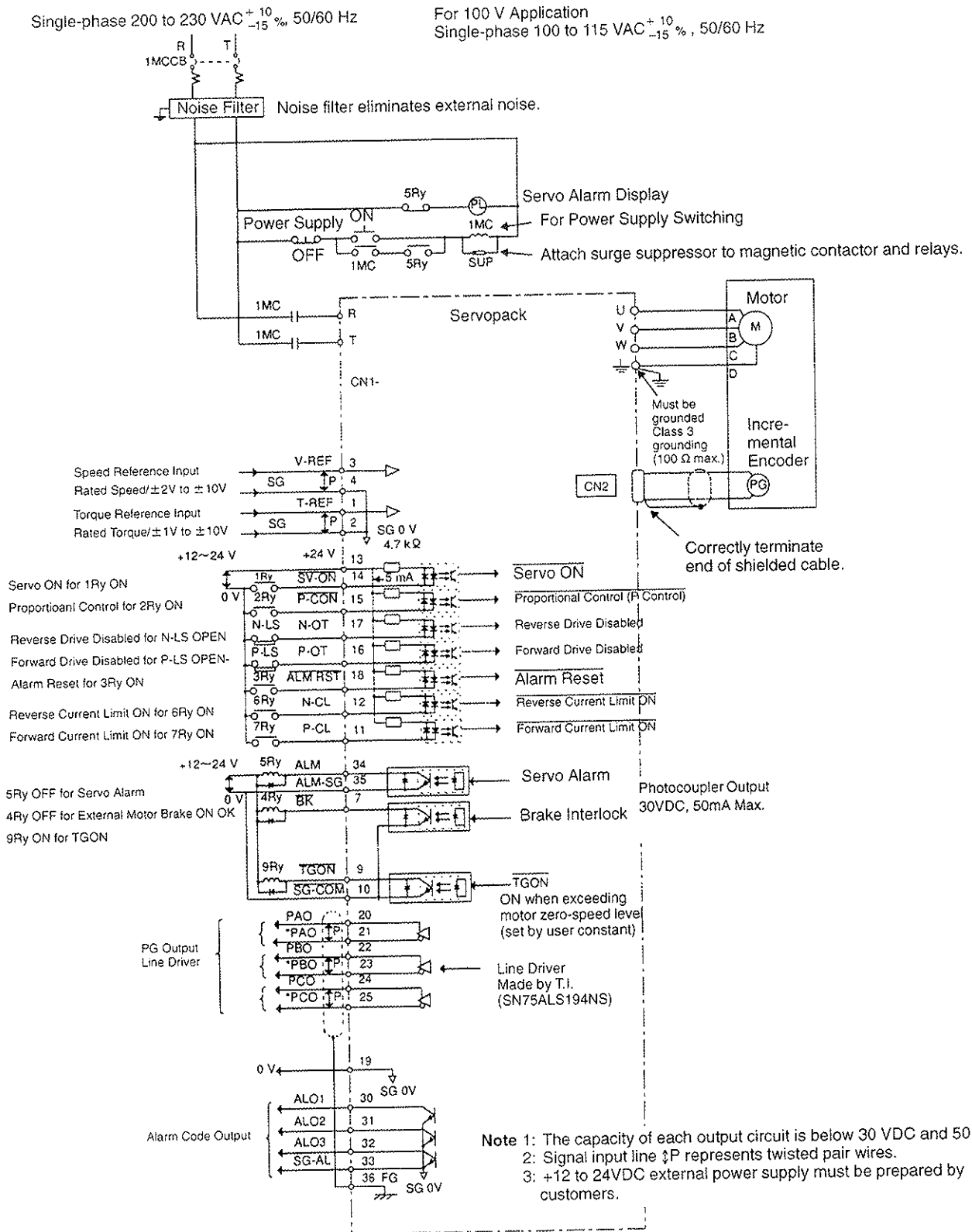

5





# Appendix **A**

## Servo Adjustment

**A**

This appendix presents the basic rules for  $\Sigma$ -L Series AC Servopack gain adjustment, describes various adjustment techniques, and gives some preset values as guidelines.

<b>A.1</b>	<b><math>\Sigma</math>-L Series AC Servopack Gain Adjustment ..</b>	<b>238</b>
A.1.1	$\Sigma$ -L Series AC Servopacks and Gain Adjustment Methods ..	238
A.1.2	Basic Rules for Gain Adjustment .....	239
<b>A.2</b>	<b>Adjusting a Speed-control Servopack .....</b>	<b>240</b>
A.2.1	Adjusting Using Auto-tuning .....	240
A.2.2	Manual Adjustment .....	241
<b>A.3</b>	<b>Gain Setting References .....</b>	<b>244</b>
A.3.1	Guidelines for Gain Settings According to Load Inertia Ratio	244

## A.1 $\Sigma$ -L Series AC Servopack Gain Adjustment

▣ This section gives some basic information required to adjust the servo system.

A.1.1	$\Sigma$ -L Series AC Servopacks and Gain Adjustment Methods .....	238
A.1.2	Basic Rules for Gain Adjustment .....	239

### A.1.1 $\Sigma$ -L Series AC Servopacks and Gain Adjustment Methods

- 1) The Servopacks allow both manual adjustment by the conventional method of observing the machine response and automatic adjustment using the internal auto-tuning function.
- 2) The main user constants changed by the customer to adjust the servo system include the following:
  - Cn-04 (Speed Loop Gain)
  - Cn-05 (Speed Loop Integration Time Constant)
  - Cn-17 (Torque Reference Filter Time Constant)
  - Cn-1A (Position Loop Gain)

A simple block diagram of the servo system is shown below.

**Servo System Block Diagram**

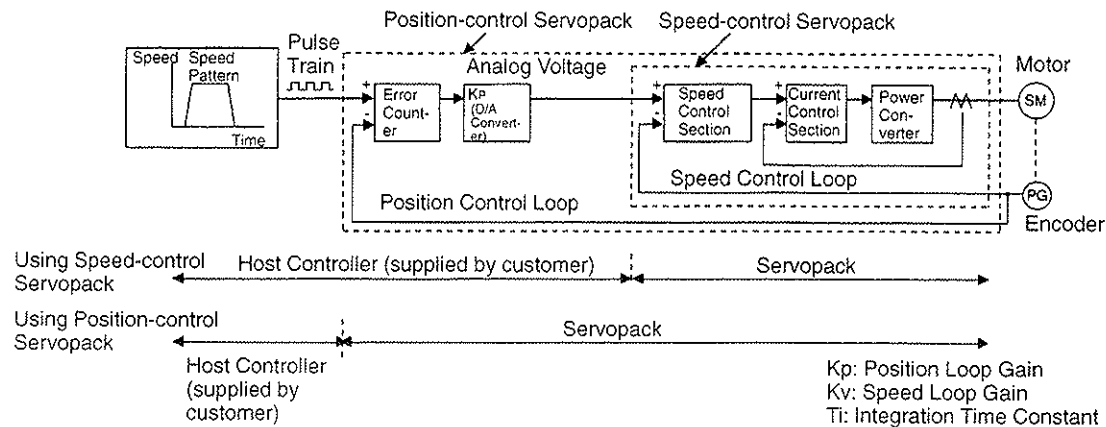

**Note:** A position-control Servopack has no D/A converter for speed reference output. This conversion is handled by internal calculations.

## A.1.2 Basic Rules for Gain Adjustment

- 1) The servo system comprises three feedback systems: position loop, speed loop, and current loop. The response must increase from outer loop to inner loop (see Servo System Block Diagram, above). The response deteriorates and oscillates if this principle is not obeyed.  
The customer cannot adjust the current loop. Sufficient response is assured for the current loop.  
The customer can adjust the position loop gain and speed loop gain, as well as the speed loop integration time constant and torque reference filter.
- 2) The position loop and speed loop must be adjusted to provide a balanced response. In particular, if the position loop gain only is increased, the speed references oscillate and the result is increased, oscillating position control times.  
If the position loop gain is increased, the speed loop gain (Cn-04) must be similarly increased.  
If the mechanical system starts to oscillate after the position loop gain and speed loop gain are increased, do not increase the gains further.
- 3) The position loop gain should not normally be increased above the characteristic frequency of the mechanical system.  
For example, the harmonic gears used in an articulated robot form a structure with extremely poor rigidity and a characteristic frequency of approximately 10 to 20 Hz. This type of machine allows a position loop gain of only 10 to 20 (1/sec).  
Conversely, the characteristic frequency of a precision machine tool such as a chip moulder or IC bonder exceeds 70 Hz, allowing a position loop gain exceeding 70 (1/sec) for some machines.  
Therefore, although the response of the servo system (controller, servo driver, motor, detectors, etc.) is an important factor where good response is required, it is also important to improve the rigidity of the mechanical system.
- 4) In cases where the position loop response is greater than or equal to the speed loop response and linear acceleration or deceleration is attempted, the poor speed loop response and follow-up cause an accumulation of position loop errors and result in increased output of speed references from the position loop.  
The motor moves faster and overshoots as a result of increased speed references, and the position loop tends to decrease the speed references. However, the poor motor follow-up due to the poor speed loop response results in oscillating speed references, as shown in the diagram below.  
If this problem occurs, reduce the position loop gain or increase the speed loop gain to eliminate the speed reference oscillations.

### Speed Reference Output with Unbalanced Position Loop Gain and Speed Loop Gain

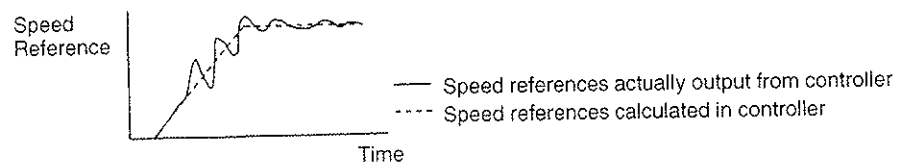

## A.2 Adjusting a Speed-control Servopack

This section gives examples of adjusting the gains of a speed-control Servopack manually and using auto-tuning.

A.2.1	Adjusting Using Auto-tuning .....	240
A.2.2	Manual Adjustment .....	241

### A.2.1 Adjusting Using Auto-tuning

#### 1) Important Points About Auto-tuning

a) Speed During Auto-tuning  
 SGDL Servopack runs at 500 r/min.

b) Selecting Machine Rigidity  
 If the machine rigidity is unknown, select the rigidity according to the following standards.

Drive Method	Machine Rigidity	
	Level	Rigidity
Ball screw, direct	3 (C-003) to 7 (C-007)	High/medium response
Ball screw, with reduction gears	2 (C-002) to 3 (C-003)	Medium response
Timing belt	1 (C-001) to 3 (C-003)	Low/medium response
Chain	1 (C-001) to 2 (C-002)	Low response
Wave reduction gears*	1 (C-001) to 2 (C-002)	Low response

\* Product name : Harmonic Drive

Select the machine rigidity level for SGDA and DR2 according to the table.

Level	Rigidity
7 (C-007)	High
6 (C-006)	:
5 (C-005)	:
4 (C-004)	:
3 (C-003)	Medium
2 (C-002)	:
1 (C-001)	Low

Auto-tuning may not end if high response is selected for a low-rigidity machine or low response is selected for a high-rigidity machine.  
 If this occurs, halt the auto-tuning and change the machine-rigidity selection.

## 2) If Auto-tuning is Unsuccessful

Auto-tuning may be unsuccessful (the end of auto-tuning not displayed) for machines with large play or extremely low rigidity.

Similarly, auto-tuning may be unsuccessful for a machine with high load inertia (exceeding 15 to 30 times the motor moment of inertia).

In these cases, use conventional manual adjustment.

Even if auto-tuning is successful for a machine with large fluctuations in load inertia or load torque, vibrations or noise may still occur in some positions.

## 3) Response During Operation is Unsatisfactory after Auto-tuning

Auto-tuning sets the gain and integration time constant with some safety margin (to avoid oscillations). This can result in positioning times.

In particular, the target position may not be reached if low response is selected, because the machine does not move in response to the final minute references. An excessively high setting of the integration time constant (Cn-05) during auto-tuning is one cause of this problem.

If response is slow after auto-tuning, the speed loop gain cannot be manually increased very much before oscillation starts.

In this case, manually reduce the integration time constant while observing the machine behavior to ensure oscillation does not occur.

Auto-tuning does not set the torque reference filter (Cn-17) or speed reference gain (Cn-03).

## A.2.2 Manual Adjustment

## 1) The role of each user constant is briefly described below.

## a) Speed Loop Gain (Cn-04)

This user constant sets the speed loop response.

The response is improved by setting this user constant to the maximum value in the range which does not cause vibrations in the mechanical system.

The following formula relates the speed loop gain to the load inertia.

$$\text{Speed Loop Gain } K_v \text{ [Hz]} = \frac{2}{\frac{GD_L^2}{GD_M^2} + 1} \times (\text{Cn-04 Preset value})$$

$GD_L^2$ : Motor Axis Converted Load Inertia

$GD_M^2$ : Motor Moment of Inertia

## b) Speed Loop Integration Time Constant (Cn-05)

The speed loop has an integration element to allow response to micro-inputs.

This integration element can produce a delay in the servo system, and the positioning setting time increases and response becomes slower as the time constant increases. However, the integration time constant must be increased to prevent machine vibration if the load inertia is large or the mechanical system includes a element that is

prone to vibration.

The following formula calculates a guideline value.

$$T_i \geq 2.3 \times \frac{1}{2\pi \times K_v}$$

Ti: Integration Time Constant (sec)

Kv: Speed Loop Gain (Hz) (calculated above)

c) Torque Reference Filter Time Constant (Cn-17)

When a ball screw is used, torsional resonance may occur which increases the pitch of the vibration noise.

This vibration can sometimes be overcome by increasing the torque reference filter time constant.

However, this filter will produce a delay in the servo system, just like the integration time constant, and its value should not be increased more than necessary.

d) Speed Reference Gain (Cn-03)

Changing the speed reference gain (Cn-03) changes the position loop gain an equivalent amount. That is, reducing the speed reference gain is equivalent to reducing the position loop gain and increasing it is equivalent to increasing the position loop gain.

Use this user constant (Cn-03) in the following circumstances:

- No position loop gain adjustment at host controller (including cases where fine adjustment not possible by changing number of D/A converter bits)
- Clamping the speed reference output range to specific speeds

Normally leave at the factory setting.

**NOTE** For SGDL Servopack used for speed control, the position loop gain (Cn-1A) is valid in zero-clamp mode only.

For normal control, change the position loop gain at the host controller or adjust the speed reference gain (Cn-03) in the Servopack.

Changing Cn-1A does not change the position loop gain.

## 2) Adjustment Procedure

a) Set the position loop gain at the host controller to a low value and increase the speed loop gain (Cn-04) within the range that no abnormal noise or vibration occurs.

If adjustment of the position loop gain is not possible at the host controller, reduce the speed reference gain (Cn-03).

b) Slightly reduce the speed loop gain from the value at step 1, and increase the position loop gain at the host controller in the range that no overshooting or vibration occurs.

If adjustment of the position loop gain is not possible at the host controller, increase the speed reference gain (Cn-03).

- c) Determine the speed loop integration time constant (Cn-05), by observing the positioning setting time and vibrations in the mechanical system.  
The positioning setting time may become excessive if the speed loop integration time constant (Cn-05) is too large.
  
- d) It is not necessary to change the torque reference filter time constant (Cn-17) unless torsional resonance occurs in the machine shafts.  
Torsional resonance may be indicated by a high vibration noise. Adjust the torque reference filter time constant (Cn-17) to reduce the vibration noise.
  
- e) Finally, fine adjustment of the position gain, speed gain, and integration time constant is required to determine the optimum point for step response.

A

## A.3 Gain Setting References

▣ This section presents tables of load inertia values for reference when adjusting the gain.

A.3.1 Guidelines for Gain Settings According to Load Inertia Ratio ..... 244

### A.3.1 Guidelines for Gain Settings According to Load Inertia Ratio

1) Adjustment guidelines are given below according to the rigidity of the mechanical system and load inertia. Use these values as guidelines when adjusting according to the procedures described above.

These values are given as guidelines only. Oscillations and poor response may occur inside the specified value ranges. Observe the response (waveform) when optimizing the adjustment.

Higher gains are possible for machines with high rigidity.

a) Machines with High Rigidity

Ball Screw, Direct Drive Machines

Example: Chip moulder, IC bonder, precision machine tools

Load/Inertia Ratio ( $GD_L^2/GD_M^2$ )	Position Loop Gain (Cn-1A) [1/s]	Speed Loop Gain (Cn-04) [Hz]	Speed Loop Integration Time Constant (Cn-05) [ms]
1 x	50 to 70	50 to 70	5 to 20  Slightly increase for inertia ratio of 20 x, or greater.
3 x		100 to 140	
5 x		150 to 200	
10 x		270 to 380	
15 x		400 to 560	
20 x		500 to 730	
30 x		700 to 1100	

For an inertia ratio of 10 x, or greater, slightly reduce the position loop gain and speed loop gain below the values shown and set the integration time constant to a higher value before starting the adjustment.

As the inertia ratio increases, set the position loop gain and speed loop gain to the lower limit of the range of values specified. Conversely, increase the speed loop integration time constant.

b) Machines with Medium Rigidity

Machines driven by ball screw through reduction gears, or machines directly driven by long ball screws.

Example: General machine tools, orthogonal robots, conveyors



Load/Inertia Ratio ( $GD_L^2/GD_M^2$ )	Position Loop Gain (Cn-1A) [1/s]	Speed Loop Gain (Cn-04) [Hz]	Speed Loop Integration Time Constant (Cn-05) [ms]
1 x	30 to 50	30 to 50	10 to 40 Slightly increase for inertia ratio of 20 x, or greater.
3 x		60 to 100	
5 x		90 to 150	
10 x		160 to 270	
15 x		240 to 400	
20 x		310 to 520	
30 x		450 to 770	

For an inertia ratio of 10 x, or greater, slightly reduce the position loop gain and speed loop gain below the values shown and set the integration time constant to a higher value before starting the adjustment.

As the inertia ratio increases, set the position loop gain and speed loop gain to the lower limit of the range of values specified. Conversely, increase the speed loop integration time constant.

c) Machines with Low Rigidity

Machines driven by timing belts, chains or wave reduction gears (product name : Harmonic Drive).

Example: Conveyors, articulated robots

Load/Inertia Ratio ( $GD_L^2/GD_M^2$ )	Position Loop Gain (Cn-1A) [1/s]	Speed Loop Gain (Cn-04) [Hz]	Speed Loop Integration Time Constant (Cn-05) [ms]
1 x	10 to 20	10 to 20	50 to 120 Slightly increase for inertia ratio of 20 x, or greater.
3 x		20 to 40	
5 x		30 to 60	
10 x		50 to 110	
15 x		80 to 160	
20 x		100 to 210	
30 x		150 to 310	

For an inertia ratio of 10 x, or greater, slightly reduce the position loop gain and speed loop gain below the values shown and set the integration time constant to a higher value before starting the adjustment.

As the inertia ratio increases, set the position loop gain and speed loop gain to the lower limit of the range of values specified. Conversely, increase the speed loop integration time constant.

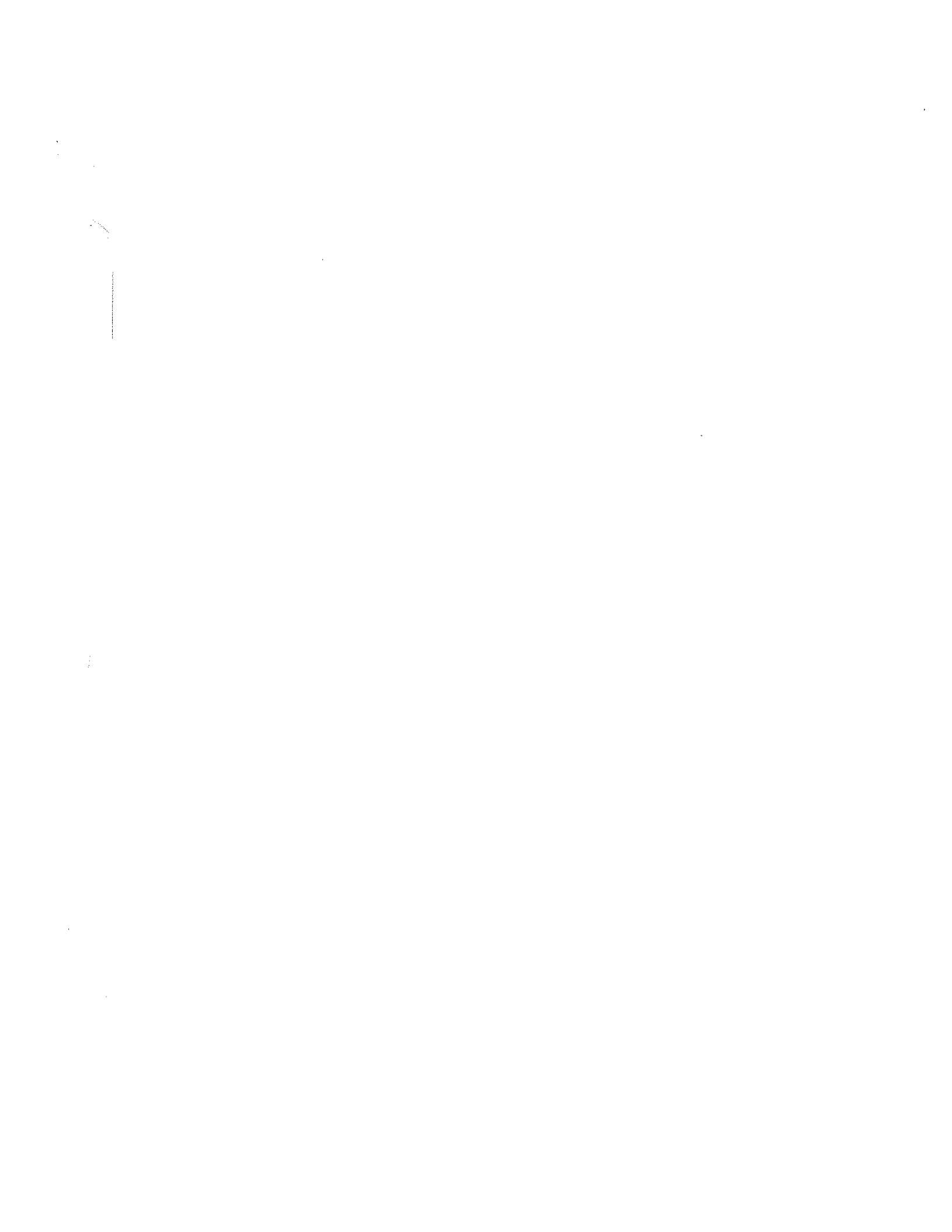

# Appendix B

## List of I/O Signals

This appendix lists I/O signal terminals (connector CN1) on Servopacks which connect to a host controller or external circuit.

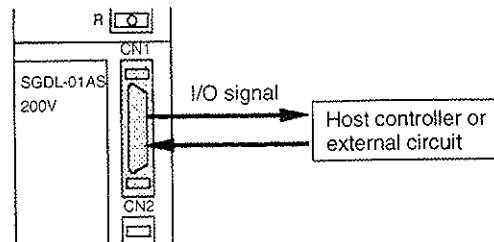

**Note** 1) Refer to *Chapter 2* for details of how to use I/O signals.

2) Note that the functions of I/O signal terminals differ according to the memory switch (Cn-01, Cn-02) settings.

List of I/O Signals (1)

Memory Switch Setting	Specifications	Standard Specifications	Torque Limit Output	Zero-clamp	Contact Input Speed Control		Speed Control with Torque Restriction by Analog Voltage Reference	
	Memory Switch Setting	Standard Setting	Cn-01 Bit 4 = 1	Cn-01 Bit A = 1 Bit B = 0	Cn-02 Bit 2 = 1		Cn-02 Bit F = 1	
					Cn-01 Bit B = 0	Cn-01 Bit B = 1		
CN1 terminal No.	1	--- (Unused)					T-REF Torque limit input	
	2	--- (Unused)					SG-T Signal ground for torque limit input	
	3	V-REF Speed reference input	2.2.1			--- (Unused)	V-REF Speed reference	
	4	SG-V Signal ground for speed reference input	2.2.1			--- (Unused)	SG-V Signal ground for speed reference	
	5	--- (Unused)						
	6	--- (Unused)						
	7	BK Brake interlock output	2.4.4					
	8	--- (Unused)						
	9	TGON Running output	2.5.3	TGON Torque limit detection	2.1.3			
	10	SG-COM Signal ground common	2.2.3					
	11	P-CL Forward rotation torque limit	2.1.3			P-CL Contact input speed control 1	P-CL Contact input speed control 1	
	12	N-CL Reverse rotation torque limit	2.1.3			N-CL Contact input speed control 2	N-CL Contact input speed control 2	
	13	P-IN +12 to 24V power supply	2.2.3					
	14	S-ON Servo ON	2.5.2					
	15	P-CON Proportional control	2.2.1		P-CON Zero-clamp operation reference	P-CON Rotation direction reference	P-CON Rotation direction reference	
	16	P-OT Forward rotation prohibited	2.1.2					

Specifications	Standard Specifications		Torque Limit Output	Zero-clamp	Contact Input Speed Control		Speed Control with Torque Restriction by Analog Voltage Reference		
	Memory Switch Setting	Standard Setting			Cn-01 Bit 4 = 1	Cn-01 Bit A = 1 Bit B = 0		Cn-02 Bit 2 = 1	
								Cn-01 Bit B = 0	Cn-01 Bit B = 1
CN1 Terminal No.	17	N-OT Reverse rotation prohibited	2.1.2						
	18	ALMRST Alarm reset	2.5.1						
	19	SG-PG Signal ground for PG signal output	2.2.2						
	20	PAO Phase A	PG signal output	2.2.2					
	21	*PAO Phase $\bar{A}$							
	22	PBO Phase B							
	23	*PBO Phase $\bar{B}$							
	24	PCO Phase C							
	25	*PCO Phase $\bar{C}$							
	26	--- (Unused)							
	27	--- (Unused)							
	28	--- (Unused)							
	29	--- (Unused)							
	30	ALO1 Alarm code output							
	31	ALO2 Alarm code output							
	32	ALO3 Alarm code output	2.5.1						
	33	SG-AL Signal ground for alarm code output							
	34	ALM Alarm output	2.5.1						
35	ALM-SG Signal ground for alarm output								
36	FG Frame ground	2.2.2							

**Note** Information described in the "Standard Specifications" column is also applicable to blank columns.  
 Number "x.x.x" in box represents a section number corresponding to each signal name. For example, 2.2.1 represents Section 2.2.1.

**B**

List of I/O Signals (2)

Specifications	Standard Specifications	Torque Control I	Torque Control II								
			Memory Switch Setting	Standard Setting	Cn-01 Bit A = 0, B = 1	Cn-01 Bit A = 1, B = 1					
						---	P-CON = ON				
							Cn-01 Bit F = 0 Cn-02 Bit F = 0	Cn-01 Bit F = 0 Cn-02 Bit F = 1			
CN1 Terminal No.	1	---	(Unused)	T-REF Torque reference	T-REF Torque reference	---	(Unused)	T-REF Torque limit value			
	2	---	(Unused)	SG-T <b>2.1.3</b> Signal ground for torque reference	SG-T Signal ground for torque reference	---	(Unused)	SG-T <b>2.2.5</b> Signal ground for torque limit value			
	3	V-REF	Speed reference input	---	(Unused)	V-REF	Speed limit value	V-REF	Speed reference	V-REF	Speed reference
	4	SG-V <b>2.2.1</b>	Signal ground for speed reference input	---	(Unused)	SG-V <b>2.2.5</b>	Signal ground for speed limit value	SG-V <b>2.2.5</b>	Signal ground for speed reference	SG-V <b>2.2.5</b>	Signal ground for speed reference
	5	---	(Unused)								
	6	---	(Unused)								
	7	$\overline{\text{BK}}$	Brake interlock output	<b>2.4.4</b>							
	8	---	(Unused)								
	9	TGON	Running output	<b>2.5.3</b>							
	10	SG-COM	Signal ground common	<b>2.2.3</b>							
	11	P-CL	Forward rotation torque limit	<b>2.1.3</b>							
	12	N-CL	Reverse rotation torque limit	<b>2.1.3</b>							
	13	P-IN	+12 to 24V power supply	<b>2.2.3</b>							
	14	S-ON	Servo ON	<b>2.5.2</b>							
	15	P-CON	Proportional control	<b>2.2.1</b>							
	16	P-OT	Forward rotation prohibited	<b>2.1.2</b>							
	17	N-OT	Reverse rotation prohibited	<b>2.1.2</b>							
	18	ALMRST	Alarm reset	<b>2.5.1</b>							
	19	SG-PG	Signal ground for PG signal output	<b>2.2.2</b>							

Specifications	Standard Specifications		Torque Control I	Torque Control II		
	Standard Setting		Cn-01 Bit A = 0, B = 1	Cn-01 Bit A = 1, B = 1		
				P-CON = OFF	P-CON = ON	
Memory Switch Setting				Cn-01 Bit F = 0 Cn-02 Bit F = 0	Cn-01 Bit F = 0 Cn-02 Bit F = 1	
CN1 Terminal No.	20	PAO Phase A	PG signal output  <b>2.2.2</b>			
	21	*PAO Phase $\bar{A}$				
	22	PBO Phase B				
	23	*PBO Phase $\bar{B}$				
	24	PCO Phase C				
	25	*PCO Phase $\bar{C}$				
	26	---	(Unused)			
	27	---	(Unused)			
	28	---	(Unused)			
	29	---	(Unused)			
30	ALO1 Alarm code output					
31	ALO2 Alarm code output					
32	ALO3 Alarm code output					
33	SG-AL Signal ground for alarm code output		<b>2.5.1</b>			
34	ALM Alarm output		<b>2.5.1</b>			
35	ALM-SG Signal ground for alarm output					
36	FG Frame ground		<b>2.2.2</b>			

**Note** Information described in the "Standard Specifications" column is also applicable to blank columns.  
Number "x.x.x" in box represents a section number corresponding to each signal name. For example, **2.2.1** represents Section 2.2.1.





# Appendix C

## List of User Constants

- $\Sigma$ -Series Servopacks provide many functions, and have parameters called “user constants” to allow the user to select each function and perform fine adjustment. This appendix lists these user constants.
- User constants are divided into the following two types:

1) Memory switch Cn-01, Cn-02	Each bit of this switch is turned ON or OFF to select a function.
2) User constant setting Cn-03 and later	A numerical value such as speed loop gain is set in this constant.

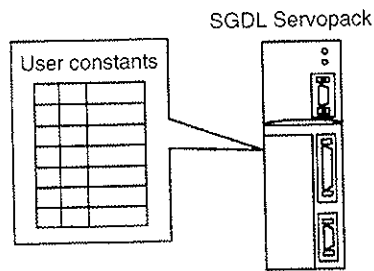

- Note**
- 1) Refer to *Chapter 2* for details of how to use user constants.
  - 2) For details of how to set user constants, refer to *Section 3.1.5 Operation in User Constant Setting Mode*.

## List of User Constants (User Constant Setting)

User Constant No.	Code	Name	Unit	Lower Limit	Upper Limit	Factory Setting	Remarks
Cn-00	Not a user constant. (Cn-00 is used to select special mode for digital operator.)						
Cn-01	Memory switch (see on page 245.)						See note 1
Cn-02	Memory switch (see on page 245.)						See note 1
Cn-03	VREFGN	Speed reference gain	(r/min)/V	0	2162	500	
Cn-04	LOOPHZ	Speed loop gain	Hz	1	2000	80	See note 2
Cn-05	PITIME	Speed loop integration time constant	1/s	2	10000	20	See note 2
Cn-07	SFSACC	Soft start time (acceleration)	ms	0	10000	0	
Cn-08	TLMTF	Forward rotation torque limit	%	0	Maximum torque	Maximum torque	
Cn-09	TLMTR	Reverse rotation torque limit	%	0	Maximum torque	Maximum torque	
Cn-0A	PGRAT	Dividing ratio setting	P/R	16	32769	1024	See note 1
Cn-0B	TGONLV	Zero-speed level	r/min	1	Maximum speed	20	
Cn-0C	TRQMSW	Mode switch (torque reference)	%	0	Maximum torque	200	
Cn-0F	ZCLVL	Zero-clamp level	r/min	0	16383	10	
Cn-12	BRKTIM	Time delay from brake reference until servo OFF	10 ms	0	50	0	
Cn-13	TCRFGN	Torque reference gain	(0.1V/ rated torque)	10	100	30	
Cn-14	TCRLMT	Speed limit for torque control I	r/min	0	Maximum speed	Maximum speed	
Cn-17	TRQFIL	Torque reference filter time constant	100 $\mu$ s	0	250	4	
Cn-18	CLMIF	Forward external torque limit	%	0	Maximum torque	100	
Cn-19	CLMIR	Reverse external torque limit	%	0	Maximum torque	100	
Cn-1A	POSGN	Position loop gain	1/s	1	500	40	See note 3
Cn-1F	SPEED1	1st speed (contact input speed control)	r/min	0	Maximum speed	100	
Cn-20	SPEED2	2nd speed (contact input speed control)	r/min	0	Maximum speed	200	
Cn-21	SPEED3	3rd speed (contact input speed control)	r/min	0	Maximum speed	300	
Cn-23	SFSDEC	Soft start time (deceleration)	ms	0	10000	0	

- Note**
- 1) After changing the setting, always turn the power OFF, then ON. This makes the new setting valid.
  - 2) Automatically set by autotuning function
  - 3) Valid only when zero-clamp function is used

## List of User Constants (Memory Switch Setting)

User Constant No.	Bit No.	Setting				Factory Setting
Cn-01	0	0		1		0
		Uses servo ON input (S-ON).		Always servo ON.		
	2	0		1		0
		Uses forward rotation prohibited input (P-OT).		Forward rotation is always possible.		
	3	0		1		0
		Uses reverse rotation prohibited input (N-OT).		Reverse rotation is always possible.		
	4	0		1		0
		Uses TGON signal (TGON) as running output.		Uses TGON signal (TGON) as torque limit output.		
8	0		1		0	
	Stops the motor by applying dynamic brake when overtravel is detected (P-OT, N-OT) .		Decelerates the motor to a stop by applying the maximum torque when overtravel is detected (P-OT, N-OT) .			
B•A	0•0	0•1	1•0	1•1	0•0	
	Speed control	Speed control with zero-clamp function	Torque control I	Torque control II		
Cn-02	0	0		1		0
		Defines counterclockwise (CCW) rotation as forward rotation.		Defines clockwise (CW) rotation as forward rotation (reverse rotation mode).		
	2	0		1		0
		Does not use contact input speed control.		Uses contact input speed control.		
	C	0		1		0
		Torque reference filter: primary		Torque reference filter: secondary		
F	0		1		0	
	Uses torque reference input.		Uses torque limit input as analog voltage reference.			





# Numbers

- CN1 connector
  - dimensional drawings, 203
  - specifications, 203
- CN1 connector kit, 13

## A

- AC servomotor sizing software, 89
- alarm code output, 72
- alarm output signals, wiring, 72
- alarm signal circuit, test run, 22
- alarm traceback data, clearing, 121
- alarm traceback mode, 110
- alarms
  - display, troubleshooting, 220
  - Servo, resetting using Digital Operator, 99
  - servo, reset, 99
- alignment, 6
  - radial load, 6
  - thrust load, 6
- autotuning, 116
  - adjustment of speed-control Servopacks, 240
  - precautions, 119
- autotuning function, 62
  - Digital Operators, 115

## B

- bits, turning ON and OFF, 105
- brake power supply, 12
  - dimensional drawings, 197
  - internal circuit, 198
  - specifications, 197

## C

- cables, 80
  - encoders
    - dimensional drawings, 199
    - specifications, 199
  - for connecting PC and Servopack, 213
  - motor
    - connectors, 194

- dimensional drawings, 190
  - specifications, 190
- specifications, 187
- tension, 80

- connections
  - contact input signal terminals, 49
  - contact output signal terminals, 50
  - I/O signal terminals, Servopack, 16

- connector kits, 193
  - dimension drawings, 193
  - specifications, 193
- connector terminal block conversion unit, 13

- connectors
  - 1CN, test run, 22
  - encoder cables, 193
  - incremental encoder, 94
  - motor cables, 194
  - standard-type motor without brake, 94
  - standard-type motor with brake, 95
  - terminal layouts, 93
- contact input signal terminals, connections, 49
- contact input speed control function, 51
  - motor speeds, 52
  - prohibiting, 42
  - soft start time, 52
- contact output signal terminals, connections, 50

## D

- Digital Operators, 13
  - alarm traceback mode, 110
  - autotuning, 115
  - connection, 98
  - dimensional drawings, 181
  - mode selection, 100
    - monitor mode, 107
    - status display mode, 101
    - user constant setting mode, 102
  - motor operation, 112
  - selection, 144
    - flowchart, 144
  - servo alarm reset, 99
  - simple motor check, 112
  - test run, 23
- dimensional diagrams, noise filter, 208
- dimensional drawings, 164
  - 1CN connector, 203
  - brake power supply, 197

- cables, encoders, 199
- connector kits, 193
- Digital Operators, 181
- magnetic contactor, 209
- motor cables, 190
- regenerative unit, 211
- Servomotors, 164–202
- Servopacks, 178

dividing, 47

dynamic brake, 68

## E

- encoder output, 47
  - signals, divided, 47
- encoders, cables
  - connectors, 193
  - dimensional drawings, 199
  - specifications, 199
- external torque limit, 40
- external torque limit input, 41
  - forward, 41
  - reverse, 41

## F

- fuse, 82

## G

- gain, adjustment, 62
  - AC Servopack, 238
  - setting references, load inertia ratio, 244
- Ground terminal, 14
- ground wire, 80
- ground-fault interrupter, 3
- grounding, 3
  - wiring, 83

## H

- high-voltage lines, Servopacks, 91
- holding brake, 70
  - electrical specifications, SGME Servomotors, 151

- host controllers, 13
- hot start, 159

## I

- I/O signal terminals, connections, 16
  - list, 248, 250
- impact resistance, 155
- input signal terminals
  - alarm reset, 75
  - forward external torque limit input, 41
  - forward rotation prohibited, 35
  - I/O power supply, 49
  - motor rotation direction, 54
  - proportional/integral control, 46
  - reverse external torque limit input, 41
  - reverse rotation prohibited, 35
  - servo ON, 75
  - signal ground for speed reference input, 43, 58
  - signal ground for torque reference input, 58
  - speed reference input, 43, 58
  - speed selection, 53
  - torque reference input, 58
  - torque/speed changeover, 59
  - zero-clamp speed control, 69
- inspection, 218, 219
  - Servomotors, 218
  - Servopacks, 219
- installation, 4
  - servomotor, alignment, 6
  - Servomotors, 5
  - Servopacks, 8
- internal torque limit, 37

## L

- limit switch, 35
  - overtravel limit function, 35
- load inertia, 160
  - gain settings, 244
- loads
  - allowable radial load, 154
  - allowable thrust load, 154

## M

- machine data table, 140

- machine rigidity, 115
  - selection, 119
- magnetic contactor, 12
  - dimensional drawings, 209
  - internal connection diagram, 209
  - specifications, 209
- maintenance, 218, 219
  - Servomotors, 218
  - Servopacks, 219
- MCCB, 12, 81, 82, 207
- mechanical tolerance, 154
- memory switches
  - See⇒ user constants
- mode selection, Digital Operators, 100
- mode switch, 65
  - detection points, torque reference, 66
- molded-case circuit breaker
  - See⇒ MCCB
- monitor mode, 107
- motor
  - checking, Digital Operators, 112
  - operation, Digital Operators, 112
  - type check, 122

## N

- N-OT input signal, 36
- noise control, 3
  - filter, 12, 81
    - dimensional diagrams, 208
    - installation, 84
    - specifications, 208
  - wiring, 82

## O

- output phase, form, 48
  - absolute encoder, 48
  - incremental encoder, 48
- output signal terminals
  - alarm code output, 73
  - brake interlock output, 71
  - encoder output, 48
  - frame ground, 48
  - output signal ground common, 50

- running output, 76
- servo alarm output, 72
- signal ground for alarm code output, 73
- signal ground for encoder output, 48
- signal ground for servo alarm output, 72
- torque limit output, 37
- overhanging load
  - precautions, 3
  - Servomotors, 162
- overload, characteristics, Servopacks, 159
- overtravel limit function, 35
  - limit switch, 35

## P

- P-OT input signal, 36
- peripheral devices
  - selection, 182
    - flowchart, 183
    - specifications, 187
  - wiring, 11
- personal computer, 13
- Power Consumption, 163
- Power Failure, 78
- Power Loss, 10
- precautions, 2
- pressure control, 55
- proportional control, 64
- proportional/integral control, 64
  - signal, 46
- protective sequence, 72
- pulse dividing ratio, 48

## R

- radial load, 6
- ratings
  - 100-VAC SGME Servomotors, 148
  - 200-VAC SGME Servomotors, 145
  - SGDE Servopacks, 156
- reference offset, 123
  - automatic adjustment, 67, 123
  - manual adjustment, 67
- regenerative unit, 12, 88
  - connection, 90

- dimensional drawings, 211
- specifications, 211
- residual voltage, precautions, 2
- reverse rotation mode, 34
  - user constant, 34
- running output signal, 76

## S

- servo ON input signal, 75
- Servomotors, 218
  - 100-VAC SGME ratings, 148
  - 100-VAC SGME specifications, 148
  - 100-VAC SGME torque-motor speed characteristics, 150
  - 200-VAC SGME ratings, 145
  - 200-VAC SGME specifications, 145
  - 200-VAC SGME torque-motor speed characteristics, 147
  - dimensional drawings, 164–202
  - inspection, 218
  - installation, 5
  - maintenance, 218
  - overhanging load, 162
  - selection, 131
    - flowchart, 133, 137
    - machine data table, 140
  - test run, 22
- Servopacks, 219
  - AC, gain adjustment, 238
  - dimensional drawings, 178
  - high-voltage lines, 91
  - inspection, 219
  - installation, 8
  - instrument connection examples, 234
  - internal connection diagram, 234
  - maintenance, 219
  - overload characteristics, 159
  - ratings, 156
  - selection, 142
    - flowchart, 143
  - specifications, 156
  - speed-control
    - autotuning, 240
    - manual adjustment, 241

- servos
  - alarm output, 72
  - alarm reset, 99

- gain adjustment, 62
- soft start function, 54, 64
- software, version check, 123

- specifications
  - 100-VAC SGME Servomotors, 148
  - 1CN connector, 203
  - 200-VAC SGME Servomotors, 145
  - brake power supply, 197
  - cables, 187
    - encoders, 199
  - connector kits, 193
  - magnetic contactor, 209
  - noise filter, 208
  - peripheral devices, 187
  - regenerative unit, 211
  - SGDE Servopacks, 156

- speed control, 45
  - zero-clamp, 45
- speed reference offset, manual adjustment mode, 12
- speed references, 43
  - gain, 46
  - inputs, 43
- starting time, 160
- status display mode, 101
- stop mode, setting, 67
- stopping time, 160
- supply voltages, precautions, 2
- surge suppressor, 210

## T

- tension control, 55
- terminals
  - standard-type motor without brake, 94
  - standard-type motor with brake, 95
- test run, 20
  - minimum user constants, 29
  - motor alone, 22
  - motor connected to the machine, 26
  - servomotor with brake, 28
- thrust load, 6
- torque control, 36, 55
- torque limit
  - input signals, 42
  - output signal, 37



- value, 61
- torque reference filter time constant, 63
- torque restriction function, 40
  - by analog voltage reference, 61
  - torque limit value, 40
- troubleshooting
  - alarm display, 220
  - without alarm display, 233

## U

- user constant setting mode, 102
- user constants, 34, 36, 42
  - contact input speed control function, 42
  - contact input speed control selection, 42, 51
  - control mode selection, 44
  - dividing ratio setting, 48
  - dividing ratio settings, 48
  - forward external torque limit, 41
  - forward rotation torque limit, 37
  - motor speeds, 52
  - N-OT input signal, 36
  - PI/P changeover, 64
  - P-OT input signal, 36
  - reverse external torque limit, 41
  - reverse rotation mode, 34
  - reverse rotation torque limit, 37
  - rotation direction selection, 34
  - servo ON input signal, 76
  - soft start time, 52, 64
  - speed limit for torque control I, 60
  - speed loop gain, 63

- speed loop integration time constant, 63
- speed reference gain, 46
- TGON output signal selection, 39, 77
- torque control, 55
- torque reference filter time constant, 63
- torque reference gain, 60, 61
- torque restriction by analog voltage reference, 61
- zero-clamp speed control, 69
- zero-speed level, 78
- zero-clamp level, 69

## V

- vibration class, 155
- vibration resistance, 155
- voltage resistance test, 3

## W

- wiring, 11, 14, 80
  - grounding, 83
  - main circuit, 14
  - more than one servo drive, 87
  - noise control, 82
  - peripheral devices, 11
  - precautions, 2, 80

## Z

- zero-clamp function, 46, 68





# Σ- L Series SGML/SGDL (for speed/torque control) USER'S MANUAL

## **TOKYO OFFICE**

New Pier Takeshiba South Tower, 1-16-1, Kaigan, Minatoku, Tokyo 105-6891 Japan  
Phone 81-3-5402-4511 Fax 81-3-5402-4580

## **YASKAWA ELECTRIC AMERICA, INC.**

2121 Norman Drive South, Waukegan, IL 60085, U.S.A.  
Phone 1-847-887-7000 Fax 1-847-887-7370

## **MOTOMAN INC. HEADQUARTERS**

805 Liberty Lane West Carrollton, OH 45449, U.S.A.  
Phone 1-937-847-6200 Fax 1-937-847-6277

## **YASKAWA ELÉTRICO DO BRASIL COMÉRCIO LTDA.**

Avenida Fagundes Filho, 620 Bairro Saude-Sao Paulo-SP, Brazil CEP: 04304-000  
Phone 55-11-5071-2552 Fax 55-11-5581-8795

## **YASKAWA ELECTRIC EUROPE GmbH**

Am Kronberger Hang 2, 65824 Schwalbach, Germany  
Phone 49-6196-569-300 Fax 49-6196-888-301

## **Motoman Robotics Europe AB**

Box 504 S38525 Torsås, Sweden  
Phone 46-486-48800 Fax 46-486-41410

## **Motoman Robotec GmbH**

Kammerfeldstraße 1, 85391 Allershausen, Germany  
Phone 49-8166-900 Fax 49-8166-9039

## **YASKAWA ELECTRIC UK LTD.**

1 Hunt Hill Orchardton Woods Cumbemauld, G68 9LF, United Kingdom  
Phone 44-1236-735000 Fax 44-1236-458182

## **YASKAWA ELECTRIC KOREA CORPORATION**

Kipa Bldg #1201, 35-4 Youido-dong, Yeongdungpo-Ku, Seoul 150-010, Korea  
Phone 82-2-784-7844 Fax 82-2-784-8495

## **YASKAWA ELECTRIC (SINGAPORE) PTE. LTD.**

151 Lorong Chuan, #04-01, New Tech Park Singapore 556741, Singapore  
Phone 65-282-3003 Fax 65-289-3003

## **YASKAWA ELECTRIC (SHANGHAI) CO., LTD.**

4F No.18 Aona Road, Waigaoqiao Free Trade Zone, Pudong New Area, Shanghai 200131, China  
Phone 86-21-5866-3470 Fax 86-21-5866-3869

## **YATEC ENGINEERING CORPORATION**

Shen Hsiang Tang Sung Chiang Building 10F 146 Sung Chiang Road, Taipei, Taiwan  
Phone 886-2-2563-0010 Fax 886-2-2567-4677

## **YASKAWA ELECTRIC (HK) COMPANY LIMITED**

Rm. 2909-10, Hong Kong Plaza, 186-191 Connaught Road West, Hong Kong  
Phone 852-2803-2385 Fax 852-2547-5773

## **BEIJING OFFICE**

Room No. 301 Office Building of Beijing International Club, 21  
Jianguomenwai Avenue, Beijing 100020, China  
Phone 86-10-6532-1850 Fax 86-10-6532-1851

## **TAIPEI OFFICE**

Shen Hsiang Tang Sung Chiang Building 10F 146 Sung Chiang Road, Taipei, Taiwan  
Phone 886-2-2563-0010 Fax 886-2-2567-4677

## **SHANGHAI YASKAWA-TONGJI M & E CO., LTD.**

27 Hui He Road Shanghai China 200437  
Phone 86-21-6531-4242 Fax 86-21-6553-6060

## **BEIJING YASKAWA BEIKE AUTOMATION ENGINEERING CO., LTD.**

30 Xue Yuan Road, Haidian, Beijing P.R. China Post Code: 100083  
Phone 86-10-6233-2782 Fax 86-10-6232-1536

## **SHOUGANG MOTOMAN ROBOT CO., LTD.**

7, Yongchang-North Street, Beijing Economic Technological Investment & Development Area,  
Beijing 100076, P.R. China  
Phone 86-10-6788-0551 Fax 86-10-6788-2878



**YASKAWA**

**YASKAWA ELECTRIC CORPORATION**

Specifications are subject to change without notice  
for ongoing product modifications and improvements.

MANUAL NO. SIE-S800-15.32B

© Printed in Japan August 1999 98-3

99-7(3)

97-71130, -71134, -23090, -23092, -23094,  
-23096, -23098, -23100